

FDA is sharing information about best practices to operate retail food stores, restaurants, and associated pick-up and delivery services during the COVID-19 pandemic to safeguard workers and consumers.

This addresses key considerations for how foods offered at retail can be safely handled and delivered to the public, as well as key best practices for employee health, cleaning and sanitizing, and personal protective equipment (PPE). This is not a comprehensive list. We encourage consulting the references and links provided below by CDC, FDA, EPA, and OSHA for more detailed information. This will be updated as FDA receives further information and inquiries.



Managing Employee Health (Including Contracted Workers)

- Instruct employees with symptoms associated with COVID-19 to report them to their supervisors. Instruct sick employees to stay home and to follow the CDC's [What to do if you are sick with coronavirus disease 2019 \(COVID-19\)](#). Consult with the local health department for additional guidance.
- If employees are sick at work, send them home immediately. [Clean and disinfect](#) surfaces in their workspace. Others at the facility with close contact (i.e., within 6 feet) of the employee during this time should be considered exposed.
- Instruct employees who are well, but know they have been exposed to COVID-19, to notify their supervisor and follow CDC-recommended precautions (see below).
- Inform fellow employees of their possible exposure to COVID-19 in the workplace, if an employee is confirmed to have COVID-19, while maintaining confidentiality.
- Implement workplace controls to reduce transmission among employees, such as those described below that are included in [CDC's Interim Guidance for Implementing Safety Practices for Critical Infrastructure Workers Who May Have Had Exposure to a Person with Suspected or Confirmed COVID-19](#).
 - Employers - Pre-screen (e.g., take temperature and assess symptoms prior to starting work).
 - Employers - Disinfect and clean work spaces and equipment, and consider more frequent cleaning of high touch surfaces.
 - Employees - Regularly self-monitor (e.g., take temperature and assess [symptoms of coronavirus](#)).
 - Employees - Wear a mask or face covering.
 - Employees - Practice social distancing and stay at least 6 feet from other people whenever possible.
- For additional information when employees may have been exposed to COVID-19, refer to [CDC's Interim Guidance for Implementing Safety Practices for Critical Infrastructure Workers Who May Have Had Exposure to a Person with Suspected or Confirmed COVID-19](#).
- For additional information on employee health and hygiene and recommendations to help prevent worker transmission of foodborne illness, refer to [FDA's Employee Health and Personal Hygiene Handbook](#).
 - If FDA recommendations differ from CDC's regarding employee health and COVID-19, follow CDC.
- For returning previously sick employees to work, refer to [CDC's Guidance for Discontinuation of Home Isolation for Persons with COVID-19](#).
- Follow [CDC](#) and [FDA](#) information on PPE (i.e., gloves, face masks/coverings, and protective gear).
- Frequently review CDC's [Interim Guidance for Business and Employers to Plan and Respond to Coronavirus Disease 2019](#).
- Understand risk at the workplace — use [OSHA's Guidance on Preparing Workplaces for COVID-19](#).



Personal Hygiene for Employees

- Emphasize effective hand hygiene including washing hands for at least 20 seconds, especially after going to the bathroom, before eating, and after blowing your nose, coughing, or sneezing.
- Always wash hands with soap and water. If soap and water are not readily available, then use an alcohol-based hand sanitizer with at least 60% alcohol and avoid working with unwrapped or exposed foods.
- Avoid touching your eyes, nose, and mouth.
- Use gloves to avoid direct bare hand contact with ready-to-eat foods.
- Before preparing or eating food, always wash your hands with soap and water for 20 seconds for general food safety.
- Cover your cough or sneeze with a tissue, then throw the tissue in the trash and wash hands after.



Managing Operations in a Foodservice Establishment or Retail Food Store

Continue to follow established food safety protocols and best practices for retail food establishments and important COVID-19 recommendations, including the following:

- Follow the 4 key steps to food safety: Always — [Clean, Separate, Cook, and Chill](#).
- Wash, rinse, and sanitize food contact surfaces dishware, utensils, food preparation surfaces, and beverage equipment after use.
- Frequently disinfect surfaces repeatedly touched by employees or customers such as door knobs, equipment handles, check-out counters, and grocery cart handles, etc.
- Frequently clean and disinfect floors, counters, and other facility access areas using [EPA-registered disinfectants](#).
- Prepare and use sanitizers according to label instructions.
- When changing your normal food preparation procedures, service, delivery functions, or making staffing changes, apply procedures that ensure:
 - Cooked foods reach the proper internal temperatures prior to service or cooling.
 - Hot foods are cooled rapidly for later use – check temperatures of foods being cooled in refrigerators or by rapid cooling techniques such as ice baths and cooling wands.
 - The time foods being stored, displayed, or delivered are held in the danger zone (between 41°F and 135°F) is minimized.
 - Proper training for food employees with new or altered duties and that they apply the training according to established procedures.
- Help customers maintain good infection control and social distancing by:
 - Discontinuing operations, such as salad bars, buffets, and beverage service stations that require customers to use common utensils or dispensers.
 - Finding ways to encourage spacing between customers while in line for service or check out in accordance with the applicable State or local requirements.
 - Discouraging customers from bringing pets — *except* service animals — into stores or waiting areas.
- Continue to use sanitizers and disinfectants for their designed purposes.
- Verify that your ware-washing machines are operating at the required wash and rinse temperatures and with the appropriate detergents and sanitizers.
- Remember that hot water can be used in place of chemicals to sanitize equipment and utensils in manual ware-washing machines.
- If you donate food to food recovery or charitable organizations, check for State and local guidelines. You can also find further information at [Conference for Food Protection](#).



Managing Food Pick-Up and Delivery

- Observe established food safety practices for time/temp control, preventing cross contamination, cleaning hands, no sick workers, and storage of food, etc.
- Have employees wash hands often with soap and water for at least 20 seconds, especially after going to the bathroom, before eating, after blowing their nose, coughing or sneezing, or after touching high touch surfaces, e.g., doorknobs, and doorbells.
 - If soap and water are not readily available, use an alcohol-based hand sanitizer with at least 60% alcohol. Always wash hands with soap and water if hands are visibly dirty. See, CDC's [How to Protect Yourself & Others](#).
- Increase the frequency of cleaning and disinfecting of high-touch surfaces such as counter tops and touch pads and within the vehicle, by wiping down surfaces using a regular household cleaning spray or wipe.
 - Make sure to read the label and follow manufacturer's instructions on use.
- Establish designated pick-up zones for customers to help maintain social distancing.
- Practice social distancing when delivering food, e.g., offering "no touch" deliveries and sending text alerts or calling when deliveries have arrived.
- Conduct an evaluation of your facility to identify and apply operational changes in order to maintain social distancing if offering take-out/carry-out option by maintaining a 6-foot distance from others, when possible.
- Keep hot foods hot and cold foods cold by storing in appropriate transport vessels.
 - Keep cold foods cold by keeping enough coolant materials, e.g., gel packs.
 - Keep hot foods hot by ensuring insulated cases are properly functioning.
- Keep foods separated to avoid cross contamination, e.g., keeping raw foods separated from cooked and ready-to-eat foods.
- Ensure that any wrapping and packaging used for food transport is done so that contamination of the food is prevented.
- Routinely clean and sanitize coolers and insulated bags used to deliver foods.

HEALTH+ SAFETY AT WORK

FOLLOW STANDARD PRECAUTION



wear mask · wear gloves · hand sanitizing · wash hand
#staysafe #stopthespread



WE SUPPLY IN-STORE+ STAY SAFE



Lau Choy Seng Pte Ltd
(Singapore HQ)
www.lauchoseng.com
Tel: +65 6223 5486
Email: marketing@lauchoseng.com

LCS Hospitality Solutions Sdn Bhd
(Malaysia Office)
www.lcshospitality.com
Tel: +603 5612 7188
Email: info@lcshospitality.com

In support of the best practice advice and need for current pandemic, we compile a list of must-have so that you can serve your customer with confidence.



Be Healthy, Be Clean Social Distance

Clean, Disinfect Pick-Up & Delivery



Source From:



Summary of Best Practices for Retail Food Stores, Restaurants, and Food Pick-Up/ Delivery Services During Covid-19 Pandemic

Be Healthy, Be Clean



1.



PROTECTIVE GEAR



2.

1. Protective Suit
2. Rubber Gloves
3. Spit Guard
4. 3-Ply Face Mask



//
EAT CLEAN
DRINK WATER
STAY ACTIVE
BE HEALTHY
//



5.



6.

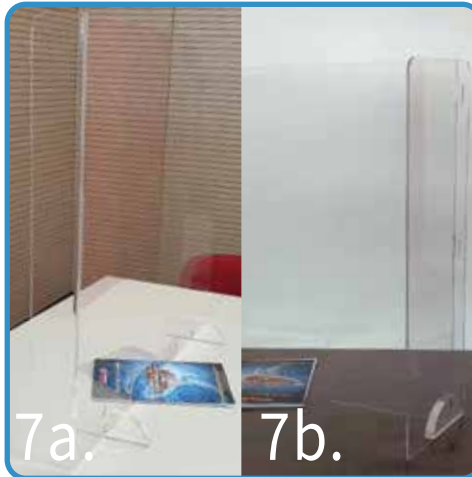

7a.

7b.

PROTECTIVE PANEL/GUARD

5. Portable Handwash Station
6. Sneeze Guard Board, GourmetWare
- 7a. Protective Panel for Desk/Board, Covid-19 Shield C
- 7b. Protective Panel for Desk/Board, Covid-19 Shield I
8. Protective Panel Floor Standing, Tab Shield

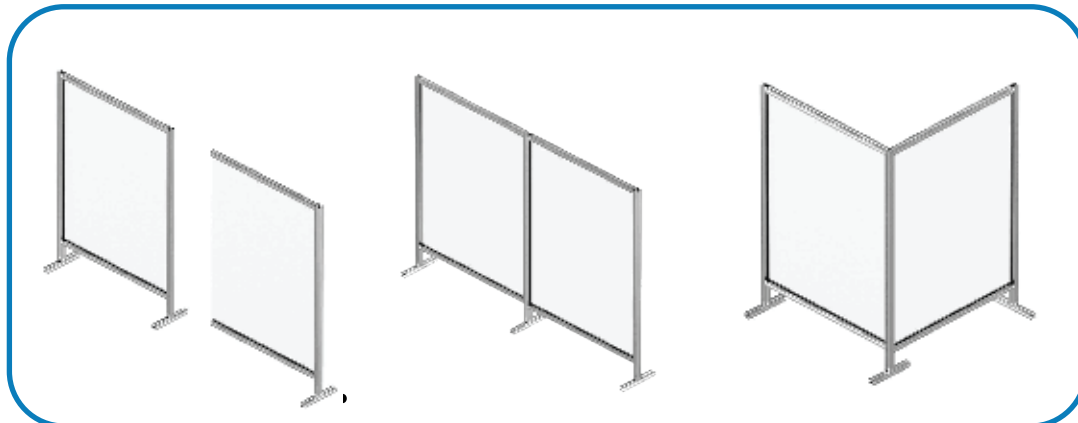

Be Healthy, Be Clean



HANDWASH ACCESSORY – FOR CAMTAINERS® & ULTRA CAMTAINERS®

- Set up a Handwashing Station quickly and easily on or off premise.
- Convenient and economical way to meet health department hand washing requirements.
- Attaches to Camtainers 250LCD, 500LCD or Ultra Camtainers UC250, UC500.
- Includes four Handwash Only labels and an Easy Serve Dispenser lever.

Handwash Accessory Stocking Colors: Dark Brown (131), Black (110).

Easy Serve Dispenser Color: Black (110).

Riser Colors: See optional accessories with Camtainers.

Pail with Bail Color: White (148).

Handwash Accessory is covered by the following U.S. Patent D 506,634 S & D 506,899 S.



CODE	HWAPR	HWATD
DESCRIPTION	With paper towel roll holder	With multi-fold paper towel dispenser
FITS	250LCD, 500LCD, UC250, UC500	250LCD, 500LCD, UC250, UC500

Optional Accessories



CODE	R500LCD	R1000LCD	LCDCH	LCDCH10
DESCRIPTION	Riser	Riser	Condiment Holder	Condiment Holder
EXTERIOR DIM. D x W x H	41,5 x 23 x 12 cm	49,5 x 39 x 11,5 cm	42 x 22 x 13 cm	51 x 41 x 12 cm
FITS	250LCD, 500LCD, UC250, UC500	1000LCD, UC1000	250LCD, 500LCD, UC250, UC500	1000LCD, UC1000

Case Pack: 1 Colors: Coffee Beige (157), Dark Brown (131), Black (110).



PWB22
Pail with Bail

6



LCDES
Easy Serve Dispenser
LCD Spigots
UC Spigots

1



COVID-19 SHIELD C

pannello protettivo da tavolo e bancone
protective panel for desk and boards

- Realizzato in plexiglass trasparente
- Si adatta a scrivanie, banconi e postazioni di servizio al cliente
- Struttura protettiva unica, con pieghe per pareti laterali
- Facilissimo da posizionare e installare

Dimensioni: L 900 x P 250 x H 750 mm
spessore: 4 mm
2 piedini da appoggio sp. 20 mm
Foro centrale dim. 300 x H 150 mm

Facile da pulire e sanificare

- Made of transparent Plexiglass
- Suitable for desks, boards, serving counters or cash corners
- Curved single piece shield with high thickness feet
- Easy positioning and installation

Dimensions: L 900 x P 250 x H 750 mm
Thickness: 4 mm
2 holding feet 20 mm thick
Servong hole 300 x h 150 mm

Easy to clean and sanitize





COVID-19 SHIELD I

pannello protettivo da tavolo e bancone
protective panel for desk and boards

- Realizzato in plexiglass trasparente
- Si adatta a scrivanie, banconi e postazioni di servizio al cliente
- Pareti laterali ad incastro
- Completamente smontabile
- Facilissimo da posizionare e installare

Dimensioni: L 900 x P 200 x H 750 mm
spessore: 4 mm
2 piedini da appoggio sp. 20 mm
Foro centrale dim. 300 x H 150 mm

Facile da pulire e sanificare

- Made of transparent Plexiglass
- Suitable for desks, boards, serving counters or cash corners
- Joint sides
- Can be completely disassembled
- Easy positioning and installation

Dimensions: L 900 x P 250 x H 750 mm
Thickness: 4 mm
2 holding feet 20 mm thick
Servong hole 300 x h 150 mm

Easy to clean and sanitize



Be Healthy, Be Clean



TAB SHIELD

pannello protettivo da pavimento
protective panel floor standing

- Struttura in alluminio anodizzato modulare
- Pannello in plexiglass trasparente da 4 mm
- Da pavimento
- Facilissimo da posizionare e installare
- Struttura protettiva singola TAB Shield 10x17 o composta con modulo aggiuntivo TAB Shield 10x17+

TAB Shield 10x17

Dimensioni: mm L 1064 x H 1740

Piedini da appoggio profondità 300 mm

Peso: 17,2 Kg

TAB Shield 10x17+

Dimensioni: mm L 1024 mm x H 1740

Piedini da appoggio profondità 300 mm

Peso: 14,4 Kg

Facile da pulire e sanificare

- Modular structure in anodized aluminium
- 4 mm thickness plexiglass shield
- Floor standing
- Easy to install
- Available in single panel TAB shield 10x17 or modular with extra shield TAB Shield 10x17+

TAB Shield 10x17

Dimensions: mm L 1064 x H 1740

Holding feet 300 mm thick 300 mm

Weight: 17,2 Kg

TAB Shield 10x17+

Dimensions: mm L 1024 mm x H 1740

Holding feet 300 mm thick 300 mm

Weight: 14,4 Kg

Easy to clean and sanitize

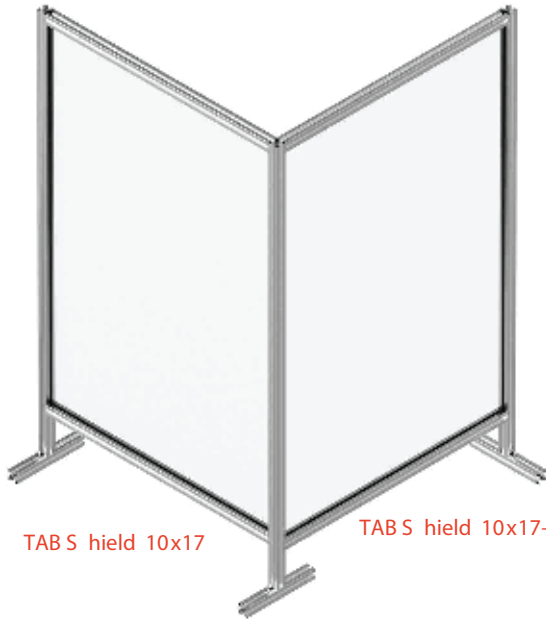

TABS hield 10x17

TABS hield 10x17+

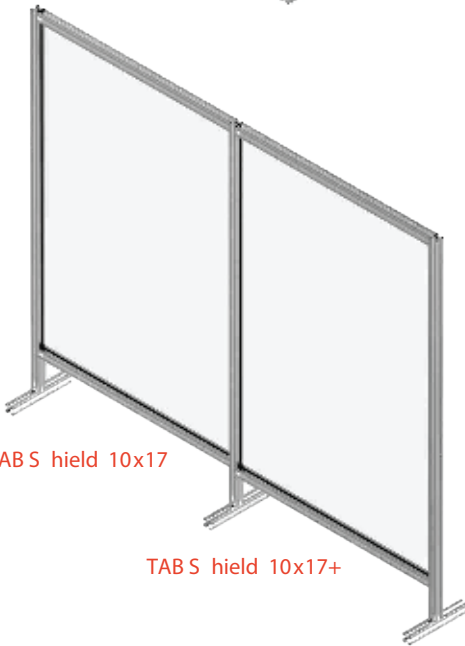

TABS hield 10x17

TABS hield 10x17+



TABS hield 10 17



TABS hield 10x17+

Be Healthy, Be Clean



BREATH GUARDS



MB98720 Back-to-back arrangement

Mobile Breath Guards

- Adjustable height 141 1/4" to 251 1/4" (36.2 cm to 64.1 cm) and angle works with most countertop serving pieces, chafers, and warmers
- Rugged steel base with powder coating
- Curved acrylic glass is durable and contemporary
- 4 sizes 2', 3', 4', and 5' (60.96 cm, 91.4 cm, 121.9 cm, and 152.4 cm) fit standard banquet tables; works as single or back-to-back
- Shipped knocked down – easy to assemble

For more detailed Mobile Breath Guard dimensions, go to VOLLRATH.com/mbreathguards.



MB98720



ITEM #	DESCRIPTION	LENGTH: IN (CM)	CASE LOT
MB98719	Chrome/black	24 (60.96)	1
MB98720	Chrome/black	36 (91.4)	1
MB98721	Chrome/black	48 (121.9)	1
MB98722	Chrome/black	60 (152.4)	1

Mobile Acrylic Breath Guards

- Convenient, durable, and portable solution to cover food serving areas
- Folds down flat and secures with magnetic latches for ease in transporting
- 3/8" (1 cm) thick acrylic panels can be securely fastened in place with easy thumb turns

Visit VOLLRATH.com/foldingbg to view a quick demo by Chef Rich.



ITEM #	DESCRIPTION	DIMENSIONS (L X W X H): IN (CM)	CASE LOT	ITEM #
MBA92819	24" (61 cm) acrylic guard w/ bag	24 x 191/2 x 16 (61 x 49.5 x 40.6)	1	2622410
MBA92820	36" (91.4 cm) acrylic guard w/ bag	36 x 191/2 x 16 (91 x 49.5 x 40.6)	1	2623610
MBA92821	48" (121.9 cm) acrylic guard w/ bag	48 x 191/2 x 16 (122 x 49.5 x 40.6)	1	2624810

Be Healthy, Be Clean



GESIGN

为了健康而设计。
Innovation for the health



折叠式飞沫隔离罩 Folding Buffet Sneeze Guard

隔绝飞沫与细菌，呵护你的健康。
Cut off the foam and bacteria, and take care of your health.

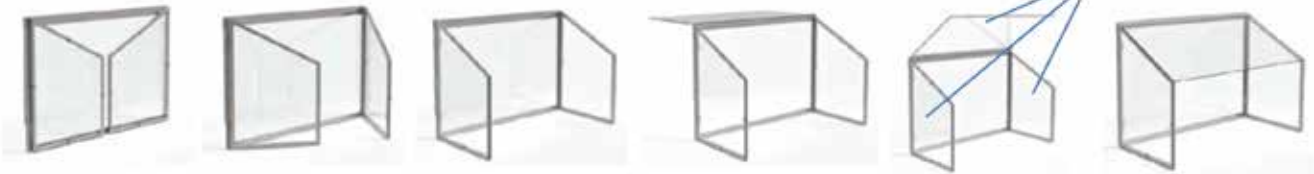

3 Pcs Acrylic panels

* Folding Brushed 304# stainless Steel frame
* Acrylic folding top and side panels with removable nuts:

* 全折叠式304#拉丝不锈钢框架
* 亚克力顶罩及侧面板，易于拆卸更换



GF-BSG02
1100*500*700(H)mm
GF-BSG12
880*400*700(H)mm



GF-BSG03
1680*500*700(H)mm
GF-BSG13
1780*500*700(H)mm

*可接受定制规格
*Customized Size Option



Be Healthy, Be Clean



revolution 2 collection



REVOL

maintien en temperature: usage professionnel
temperature regulation : professional use

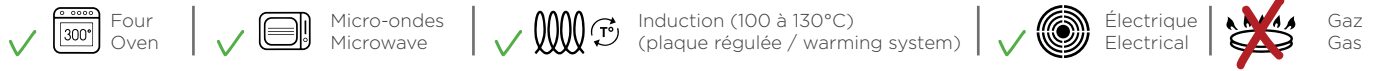

COUVERCLES / LIDS

			Noir brut / Matt slate style	Crescendo argenté / Silver	Crescendo cuivré / Copper	Cosmos platinum	Cosmos gold	Blanc satiné / Satin white	Noir satiné / Satin black	Verre / Glass
	DIMENSIONS (Ø - H* cm / inch) UE / PU	CAPACITÉ CAPACITY L / oz								
 COCOTTE R ONDE ROUND COCOTTE	Ø 19 cm - H. 12,5 cm Ø 7 1/2" - H. 5" 1	1,20L 42 1/4 oz	653345	653346	653349	653348	649819	649802	649806	
	Ø 22 cm - H. 14 cm Ø 8 3/4" - H. 5 1/2" 1	2,40L 84 3/4 oz	653350	653351	653353	653352	649818	649816	649820	
	Ø 26 cm - H. 14,5 cm Ø 10 1/4" - H. 5 3/4" 1	3,40L 120 oz	653354	653355	653357	653356	649856	649855	649857	
 COCOTTE RONDE BASSE ROUND SHALLOW COCOTTE	Ø 28 cm - H. 13,5 cm Ø 11" - H. 5 1/4" 1	3,60L 127 oz	653362	653363	653365	653364	649864	649863	649865	
 COCOTTE OVALE OVAL COCOTTE	23 x 19,5 x 14 cm 9 x 7 3/4 x 5 1/2" 1	2L 70 1/2 oz	653358	653359	653361	653360	649992	649994		
	32,5 x 26,5 x 16 cm 12 3/4 x 10 1/2 x 6 1/4" 1	3,50L 123 1/2 oz	653368	653369	653371	653370	649872	649871	649873	
 TAJINE TAJINE	Ø 32 cm - H. 21,5 cm Ø 12 1/2" - H. 8 1/2" 1	3L 105 3/4 oz	653376	653372	653373					
 PLAT RECTANGULAIRE RECTANGULAR DISH	30,5 x 21,5 x 7 cm 12 x 8 1/2 x 2 3/4" 1	2,60L 91 3/4 oz					645055			

Be Healthy, Be Clean



four et table oven and table

✓ Four Oven | ✓ Micro-ondes Microwave

Induction (100 à 130°C)
(plaque régulée / warming system)

Électrique
Electrical

Gaz
Gas



COUVERCLES / LIDS

	DIMENSIONS (Ø - H* cm / inch) UE / PU	CAPACITÉ CAPACITY L / oz	Crescendo argenté / Silver	Crescendo cuivré / Copper	Cosmos platinum	Cosmos gold	Blanc satiné / Satin white	Noir satiné / Satin black	Verre Glass
 COCOTTE R ONDE ROUND COCOTTE	Ø 10,5 cm - H. 7,7 cm Ø 4 ¼" - H. 3" 4	0,20L 7 oz	653381	653382	653384	653383	649549	649547	
	Ø 13,6 cm - H. 9,2 cm Ø 5 ¼" - H. 3 ½" 4	0,50L 17 ¾ oz	653392	653393	653395	653394	649844	649843	
	Ø 16,4 cm - H. 10,7 cm Ø 6 ½" - H. 4 ¼" 1	0,80L 28 ¼ oz	653329	653330	653332	653331	649828	649827	649829
 COCOTTE R ONDE NOIR EFFET FONTE ROUND COCOTTE CAST-IRON STYLE	Ø 10,5 cm - H. 7,7 cm Ø 4 ¼" - H. 3" 4	0,20L 7 oz						649550	
	Ø 13,6 cm - H. 9,2 cm Ø 5 ¼" - H. 3 ½" 4	0,50L 17 ¾ oz						649879	
	Ø 16,4 cm - H. 10,7 cm Ø 6 ½" - H. 4 ¼" 1	0,80L 28 ¼ oz						649881	649882









Be Healthy, Be Clean



collection **revolution 2**

REVOL

les accessoires accessories

		DIMENSIONS (Ø - H* cm / inch) UE / PU	CAPACITÉ CAPACITY L / oz	FINITION FINISH	CODE COMMANDE ORDER CODE
	INSERT BAIN-MARIE POUR COCOTTE Ø 26 cm DOUBLE BOILER INSERT FOR COCOTTE Ø 10 1/4"	Ø 26,5 cm - H. 6,5 cm Ø 10 1/2" - H. 2 1/2" 1	1,50L 53 oz	Blanc satiné Satin white	646792
	REPOSE CUIILLÈRE SPOON REST	19,7 x 10,4 x 3,8 cm 7 3/4 x 4 x 1 1/2" 3		Noir brut Matt slate style	644293
	PORTE -COUVERCLE HAUT LID SUPPORT	30,5 x 23 x 37,5 cm 12 x 9 x 14 3/4" 2		Inox Stainless steel	644282
	PORTE -COUVERCLE LID REST	12 x 6 x 8 cm 4 3/4 x 2 1/4 x 3 1/4" 6		Inox Stainless steel	645051
	PO DIUM COCOTTES Ø 10,5 cm DISPLAY FOR COCOTTE Ø 4 1/4"	44 x 15 x 2 cm 17 1/4 x 6 x 3/4" 1		Nacryl blanc White Nacryl	652069
	** PINCE PORTE-ETIQUETTE LABEL CLIP HOLDER	Ø 3 cm - H. 3,3 cm Ø 1 1/4" - H. 1 1/4" 4		Hêtre Beech	650993
	CHEVALET STAND	5,6 x 3 x 5,7 cm 2 1/4 x 1 1/4 x 2 1/4" 6		Noir brut Matt slate style	641279
	CHEVALET STAND	8 x 3,5 x 6 cm 3 1/4 x 1 1/2 x 2 1/4" 6		Noir brut Matt slate style	651032

Be Healthy, Be Clean





MEALPLAK by Revol



PIÉDESTAL
CAKE STAND
Anthracite / Anthracite

NEW 119589 
Ø 23 cm - H. 11 cm
Ø 9" - H. 4 1/4"

NEW 119763 
Ø 30 cm - H. 16 cm
Ø 11 3/4" - H. 6 1/4"

NEW 119947 
Ø 33 cm - H. 21 cm
Ø 13" - H. 8 1/4"



PIÉDESTAL
CAKE STAND
Bleu nuit / Night blue

NEW 119619 
Ø 23 cm - H. 11 cm
Ø 9" - H. 4 1/4"

NEW 119794 
Ø 30 cm - H. 16 cm
Ø 11 3/4" - H. 6 1/4"

NEW 119978 
Ø 33 cm - H. 21 cm
Ø 13" - H. 8 1/4"



CLOCHE
DOME
Polycarbonate / Polycarbonate

115444 
Ø 21 cm - H. 17 cm
Ø 8 1/4" - H. 6 3/4"

NEW 119480 
Ø 28 cm - H. 22,5 cm
Ø 11" - H. 8 3/4"

115468 
Ø 31 cm - H. 23 cm
Ø 12 1/4" - H. 9"





Piédestal + cloche
Cake stand + dome



ROUND AVEC CLOCHE
ROUND WITH DOME
Anthracite / Anthracite

116557 
Ø 23 cm - H. 18 cm
Ø 9" - H. 7"

NEW 120035 
Ø 30 cm - H. 23,5 cm
Ø 11 3/4" - H. 9"

116649 
Ø 33 cm - H. 24 cm
Ø 13" - H. 9 1/2"



ROUND AVEC CLOCHE
ROUND WITH DOME
Bleu nuit / Night blue

NEW 118629 
Ø 23 cm - H. 18 cm
Ø 9" - H. 7"

NEW 120066 
Ø 30 cm - H. 23,5 cm
Ø 11 3/4" - H. 9"

NEW 118643 
Ø 33 cm - H. 24 cm
Ø 13" - H. 9 1/2"



ROUND AVEC CLOCHE
ROUND WITH DOME
Constellation / Constellation

NEW 118636 
Ø 23 cm - H. 18 cm
Ø 9" - H. 7"

NEW 120080 
Ø 30 cm - H. 23,5 cm
Ø 11 3/4" - H. 9"

NEW 118650 
Ø 33 cm - H. 24 cm
Ø 13" - H. 9 1/2"

WE SUPPLY IN-STORE+
STAY SAFE

Lau Choy Seng Pte Ltd (Singapore HQ) · Tel: +65 6223 5486 · Email: marketing@lauchoyseng.com

LCS Hospitality Solutions Sdn Bhd (Malaysia Office) · Tel: +603 5612 7188 · Email: info@lcs hospitality.com

Clean, Disinfect



SANITIZING EQUIPMENT

- 15. Sanitotem 4 Dispenser
- 16. Glass Sanitiser/ Chiller
- 17. Ozone, O3 Tower
- 18. Ozone, O3 Port



Clean, Disinfect



SANITIZING EQUIPMENT

- 19. Knife Sterilizer
- 20. Steriliser Box

- 21. Cutlery Dryer
- 22. Glass Dryer



//
EAT CLEAN
DRINK WATER
STAY ACTIVE
BE HEALTHY
//



Clean, Disinfect



SANITOTEM 4 distributore dispenser

porta pannello indicazioni
information panel

dispenser

porta sanificante
hand sanitizing gel

porta guanti o mascherine
gloves or masks dispenser

cestino
trash bin



- Distributore presidi igienici da pavimento
- Struttura in acciaio
- 4 funzioni:
 - porta sanificante,
 - porta guanti (o mascherine)
 - cestino,
 - porta pannello indicazioni
- Facilissimo da posizionare e installare

Dimensioni: 424 x 296 x h 1415 mm

Peso: 12,5 Kg

Facile da pulire e sanificare

- Floor standing dispenser of health care supplies
- Stainless steel structure
- 4 standard features:
 - and sanitizing gel dispenser
 - gloves or masks dispenser
 - trash bin
 - information panel
- Ready to use and easy to install

Dimensions: 424 x 296 x h 1415 mm

Weight: 12,5 Kg

Easy to clean and sanitize



Clean, Disinfect



THRILL® VORTEX CUBE

New THRILL® with a more compact design.
The ideal solution for sanitizing glasses thoroughly and chilling them instantly.



Technical Specifications:

Outside Dimensions	7.87" x 7.87" x 6.69" h (cm 20 x 20 x 17 h)
Unit Weight	12.8 lb (5,8 kg) approx. with battery and 9.5 lb (4,3 kg) approx. without battery (excluding CO2 cylinder)
Gas Refrigerant	CO2 (Food Grade) Carbon Dioxide
Cylinder Type	CO2 Cylinder with Siphon tube (not included)
CO2 Line Standard Length	Approx. 10 feet (including connection valve)
Power Supply	Rechargeable 12V battery – 100/240 V AC Plug
Power Input	100 – 240 V AC
Frequency	50 – 60 Hz
Max Power Capacity	50 W
Battery Charger	Included

All dimensions and specifications are subject to change.

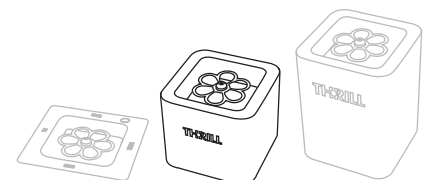

Clean, Disinfect



THRILL® VORTEX F1-PRO

THRILL® continues to be the leader in sanitization and refrigeration for the professional marketplace.



Technical Specifications:

Outside dimensions	7.87" x 7.87" x 10.12" h (cm 20 x 20 x 25,7 h)
Unit Weight	16.53 lb (7,5 kg) approx. with battery and 13.22 lb (6 kg) approx. without battery (excluding CO2 cylinder)
Gas Refrigerant	CO2 (Food Grade) Carbon Dioxide
Cylinder Type	CO2 Cylinder with Siphon tube (not included)
CO2 Line Standard Length	Approx. 10 feet (including connection valve)
Power Supply	Rechargeable 12V battery – 100/240 V AC Plug
Power Input	100 – 240 V AC
Frequency	50 – 60 Hz
Max Power Capacity	50 W
Battery Charger	Included

All dimensions and specifications are subject to change.

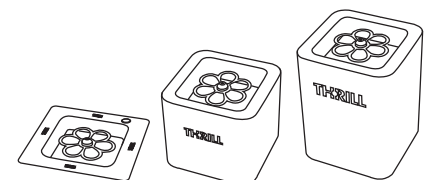

Clean, Disinfect



THRILL® VORTEX S.B.I.

Special for Built In

THRILL® releases the new VORTEX built in. The leader in sanitization and refrigeration solutions to the professional marketplace.



Technical Specifications:

Outside Dimensions	8.66" x 8.66" (cm 22 x 22)
Opening Size	7.67" x 7.67" (cm 19,5 x 19,5)
Overall Depth	7.87" (cm 20) with battery / 5.12" (cm 13) without battery
Unit Weight	9.92 lb (4,5 kg) approx. with battery and 6.61 lb (3 kg) approx. without battery (excluding CO2 cylinder)
Gas Refrigerant	CO2 (Food Grade) Carbon Dioxide
Cylinder Type	CO2 Cylinder with Siphon tube (not included)
CO2 Line Standard Length	Approx. 10 feet (including connection valve)
Power Supply	Rechargeable 12V battery – 100/240 V AC Plug
Power Input	100 – 240 V AC
Frequency	50 – 60 Hz
Max Power Capacity	50 W
Accessories	Worktop mounting kit and Battery Charger

All dimensions and specifications are subject to change.

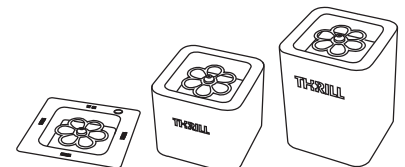

Clean, Disinfect



THRILL[®] TAP

Your drinks at their best.

THRILL releases the new TAP. Leader on the market with sanitization and re Fridgeration products designed for professional catering services.



Technical Specifications:

Size	25.394" x 9.252" x 3.14" (cm 64,5 x 23,5 x 8 h)
Unit Weight	13.89 lb (6,3kg) approx. (excluding CO ₂ cylinder)
Gas Refrigerant	CO ₂ (Food Grade) Carbon Dioxide
Cylinder Type	CO ₂ Cylinder with Siphon tube (not included)
CO ₂ Line Standard Length	Approx. 98.425" (2,5 mt) including connection valve
Power Supply	Rechargeable 12V battery - 100/240 V AC Plug
Power Input	100 - 240 V AC
Frequency	50 - 60 Hz
Max Power Capacity	50 W
Accessories	Worktop mounting kit and Battery Charger

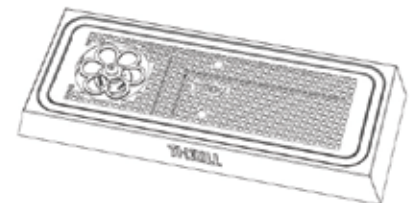

Clean, Disinfect



O3 TOWER sanificatore all'ozono sanitizing ozone generator

- Sanificatore da pavimento a produzione di Ozono (O3)
- Adatto ad ambienti fino a 200 mq.
- Sanificazione in 30 minuti (1g/h per 10m³ in 30 min)
- Particolarmente indicato per muffe, batteri, virus e cattivi odori
- Timer 0-60 minuti
- Costruzione in acciaio inox Aisi 304

Potenza: 200 Watt (O3 Tower 28)
370 Watt (O3 Tower 56)

Alimentazione: 220 V
Produzione O3: 28g/h (O3 Tower 28)
56g/h (O3 Tower 56)

Dimensioni: 232 x 144,5 x h 690,5
Larghezza corpo: 173 mm
Peso: 6,5 Kg

- Floor standing sanitizing ozone generator (O3)
- Suitable up to 200 sqm rooms.
- Sanitizes cycle 30 minutes (1g/h for 10m³ within 30 min)
- Dedicated to mold, bacteria and virus killing
- Timer 0-60 minutes
- Stainless steel Aisi 304 construction

Power: 200 Watt (O3 Tower 28)
370 Watt (O3 Tower 56)

Power source: 220 V
O3 production: 28g/h (O3 Tower 28)
56g/h (O3 Tower 56)

Dimensions: 232 x 144,5 x h 690,5
Body Weight: 6,5 Kg

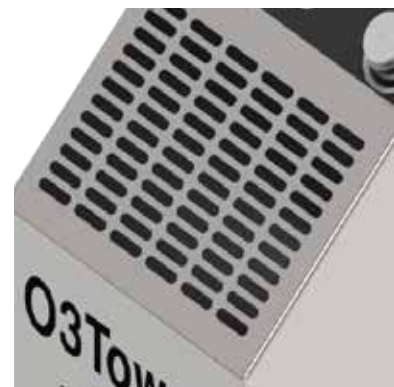

Clean, Disinfect



O3 PORT sanificatore all'ozono sanitizing ozone generator



- Sanificatore portatile a produzione di Ozono (O3)
- Adatto ad ambienti fino a 100 mq.
- Sanificazione in 30 minuti (1g/h per 10 m)
- Particolarmente indicato per muffe, batteri, virus e cattivi odori
- Timer 0-60 minuti
- Costruzione in alluminio anodizzato e acciaio inox Aisi 304

Potenza: 100 Watt (O3 Port 10)
200 Watt (O3 Port 28)

Alimentazione: 220 V

Produzione O3: 10g/h (O3 Port 10)
28g/h (O3 Port 28)

Dimensioni: 244 x 210 x h 240 mm

Interasse piedini: 210 x 140 mm

Peso: 4,2 Kg

- Portable sanitizing ozone generator (O3)
- Suitable up to 100 sqm rooms.
- Sanitizes cycle 30 minutes (1g/h for 10 m)
- Dedicated to mold, bacteria and virus killing
- Timer 0-60 minutes
- Construction in anodized aluminum and Aisi 304 stainless steel.

Power: 100 Watt (O3 Port 10)
200 Watt (O3 Port 28)

Power source: 220 V

O3 production: 10g/h (O3 Port 10)
28g/h (O3 Port 28)

Dimensions: 244 x 210 x h 240 mm

Distance between feet: 210 x 140 mm

Weight: 4,2 Kg



Clean, Disinfect



STER. UV 24W

STERILIZZATORI UV



sterilizzatori sterilizers

- Costruiti interamente in acciaio inox AISI 430.
 - Porta in plexiglass fumè che chiude perfettamente la camera.
 - Portacoltelli in plexiglass trasparente totalmente estraibile per una migliore pulizia e consente di sterilizzare i coltelli senza doverli girare.
 - mod. 24W con esclusiva vaschetta di raccolta gocce, incorporata con il portacoltelli.
 - Lampade UV ai vapori di mercurio con protezione in rete metallica.
 - Microinterruttore di sicurezza che spegne le lampade all'apertura della porta e viceversa alla chiusura.
 - Particolare lampada di cortesia per il mod. 24W, che si accende solo se l'interruttore è in posizione "ON" e il timer a "0".
- Made from AISI430 stainless steel.
 - Chamber is closed by a smoked plexiglass door.
 - Removable see-through plexiglass knives holder makes sanitation easier and allows sterilization without having to rotate the knives.
 - Knives holder with built in drops collecting tray (only on 24W version).
 - Mercury vapour lamp UV with wire screen protection.
 - A safety microswitch switches the lamps on when the door is opened and switches them off when it is closed.
 - The curtesy lamp, on 24W model, turns on only when the switch is "on" and the timer is at "0".

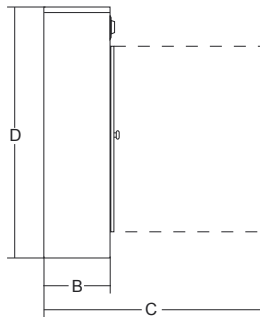
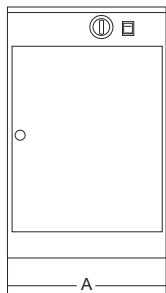

Portacoltelli asportabile su mod. 24 W
Knife storage unit removable for mod. 24 W

	watt				mm	mm	mm	mm	mm	kg	mm	kg	
Steril. UV 16W	2x8	1ph	70 - 0,3A	0÷120	15	310	400	140	520	620	9	470x250x700	11
Ster. UV Napoli	2x8	1ph	70 - 0,3A	0÷120	15	450	400	140	520	760	10	470x250x820	12
Ster. UV 24W	3x8	1ph	100 - 0,5A	0÷120	20	290	400	300	690	620	14,5	470x400x700	16,5



STER. UV NAPOLI



STERIL. UV 16W

Clean, Disinfect



STER UVC 24W S

STERILIZZATORI UVC sterilizzatori sterilizers

- Made from AISI430 stainless steel.
- Chamber is closed by a smoked plexiglass door.
- Removable internal holder in transparent plastic.
- Easily holds glasses, cutlery and accessories with no need to turn them for perfect bacteria and virus sterilization.
- Drops collecting tray.
- Mercury vapour lamp UV with wire screen protection.
- A safety microswitch switches the lamps on when the door is opened and switches them off when it is closed.
- The courtesy lamp, on 24W model, turns on only when the switch is "on" and the timer is at "0".

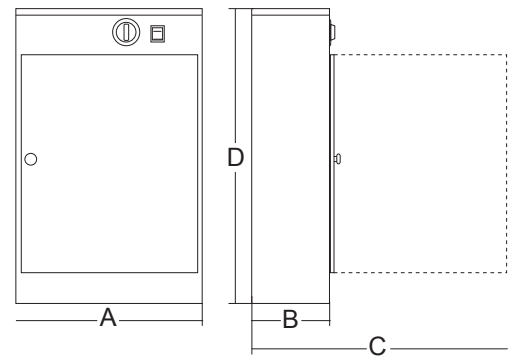

	watt		watt	min.	mm	mm	mm	mm	kg	mm
Ster UVC 24W S	3x8	1ph	100 - 0,5A	0÷120	400	300	690	620	14.5	470x400x700

KG



STER UVC 24W S

Clean, Disinfect



STERILIZZATORI UVC sterilizzatori sterilizers



VISTA UVC 16W SH

Ripiani per bicchieri, posate e accessori
Shelves holds glasses, cutlery and accessories

- Made from stainless steel, aluminium and plexiglass.
- Front black plexiglass door
- Anodized aluminium body
- Model S: 1 plastic removable transparent shelf
- Model SH: 1 or 2 plastic removable transparent shelves
- Model T: plastic removable transparent holder for tablets
- Easily holds glasses, cutlery and accessories with no need to turn them for perfect bacteria and virus sterilization
- Mercury vapour lamp UV with wire screen protection.
- A safety microswitch switches the lamps on when the door is opened and switches them off when it is closed.

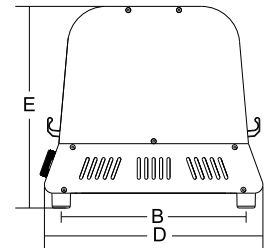
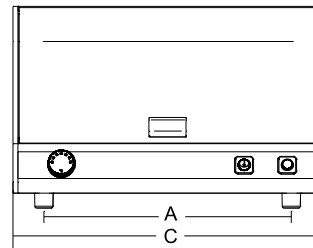

	watt		watt	min.	mm	mm	mm	mm	mm	kg
Vista UVC 16W S	2x8	1ph	70 - 0,3A	0÷120	400	300	500	355	325	10
Vista UVC 16W SH - TH	2x8	1ph	70 - 0,3A	0÷120	400	300	500	355	405	14
Vista UVC 24W SH - TH	3x8	1ph	100 - 0,5A	0÷120	400	300	500	355	405	14

	mm	kg
	620x430x350	14
	620x430x450	18
	620x430x450	18

Supporto per tablete
Tablets holder



VISTA UVC 24W TH

Clean, Disinfect



professional
drying

Model SV2000 Glass Polisher

- Polish 400-500 glasses/hour
- Allow to work with both hands.
- Compatible with any type of glasses and cups
- Hot air fan motor

Dimension: 590 x 320 x 490 mm



Clean, Disinfect



professional
drying

Model SV1000 Glass Polisher

- Polish 240-360 glasses/hour
- Professional Hygienic Polishing
- Compatible with any type of glasses and cups
- Natural, flexible and absorbent fiber brush

Dimension: 340 x 305 x 520 mm



Social Distance



Set pick-up station to support social distancing.
#stopthespread #staysafe

Flex Station & Guide Support

23. Camshelving
Flex Station

24. Q-Pole

Social Distance



CAMSHELVING® FLEX STATION SYSTEM



A Flexible Grab-N-Go System

Premium Series Flex Station
shown with optional Flex Station
Merchandiser and Storage Accessories

- Offer Grab-N-Go service at convenient locations and reach more kids in less time.
- Promote healthy options and eating habits.
- Configure unit to support specific product and serving needs.
- New optional merchandiser is quick and easy to install and helps visually promote healthy food choices. Order separately.

CAMBRO
TRUSTED FOR GENERATIONS™

www.cambro.com

Social Distance



Camshelving® Flex Station



Shown with Optional Food Storage Boxes

- Store products on an angle for quick and convenient access for kids and for replenishing.
- Configure with food pans/boxes to fit your serving needs.
- Lifetime warranty against rust and corrosion on posts and traverses.
- Includes 4 highly durable, non-corrosive plastic swivel casters. Total locking brake locks swivel motion and caster.

CODE	DESCRIPTION	DIMENSIONS D x L x H
CPMU244867FXPKG	Premium Series Flex Station	24" x 48" x 67"

Unit Includes: 2 unassembled mobile post kits, 8 traverses, 36 angled divider bars (4 extra), 4 total locking casters and 24 identification tags. Assembly required. Ships in 17 cartons. Height includes casters. **Color:** Speckled Gray (480).



COMPONENT

Flex Station Merchandiser



Merchandiser ships complete in one box.

- Attract more kids and increase participation with colorful graphics.
- Black magnetic frame with matte vinyl finish holds up to 8½" x 11" menu or information at eye level.
- Easy to install and clean.
- Withstands years of use with proper care and handling.

CODE	CSFLEXMERCH
DESCRIPTION	Camshelving® Flex Station Merchandiser
SIDE PANEL DIMENSIONS W x H	23" x 56"
HEADER DIMENSIONS L x H	48" x 8"
CASE PACK	1

Overall Unit Height: 75¾". **Color:** (000).



Storage Accessories



CODE	16CW	24LPCW	12189CW	1218SCCW	CP814
DESCRIPTION	Full Size Camwear® Food Pan	Half Size Long Camwear Food Pan	Half Size Camwear Food Box	Camwear SlidingLid™ for Food Box	Compact Camchiller® for Half Size Food Box
COLORS	Black (110), Clear (135), White (148)	Black (110), Clear (135), White (148)	Clear (135)	Clear (135)	Cold Blue (159)
DIMENSIONS D x L x H	12¾" x 20½" x 6"	6¾" x 20½" x 4"	12" x 18" x 9"	12" x 18"	8" x 14" x 1½"
CASE PACK	6	6	6	6	1



CA PROP 65

WARNING: This product can expose you to chemicals including Vinyl chloride which is known to the State of California to cause cancer. For more information, go to www.P65warnings.ca.gov. Warning applies to State of California only.

For more information about Cambro products visit www.cambro.com or contact your Distributor, Cambro Sales Representative or the Cambro Customer Service Department.

Pick-Up & Delivery

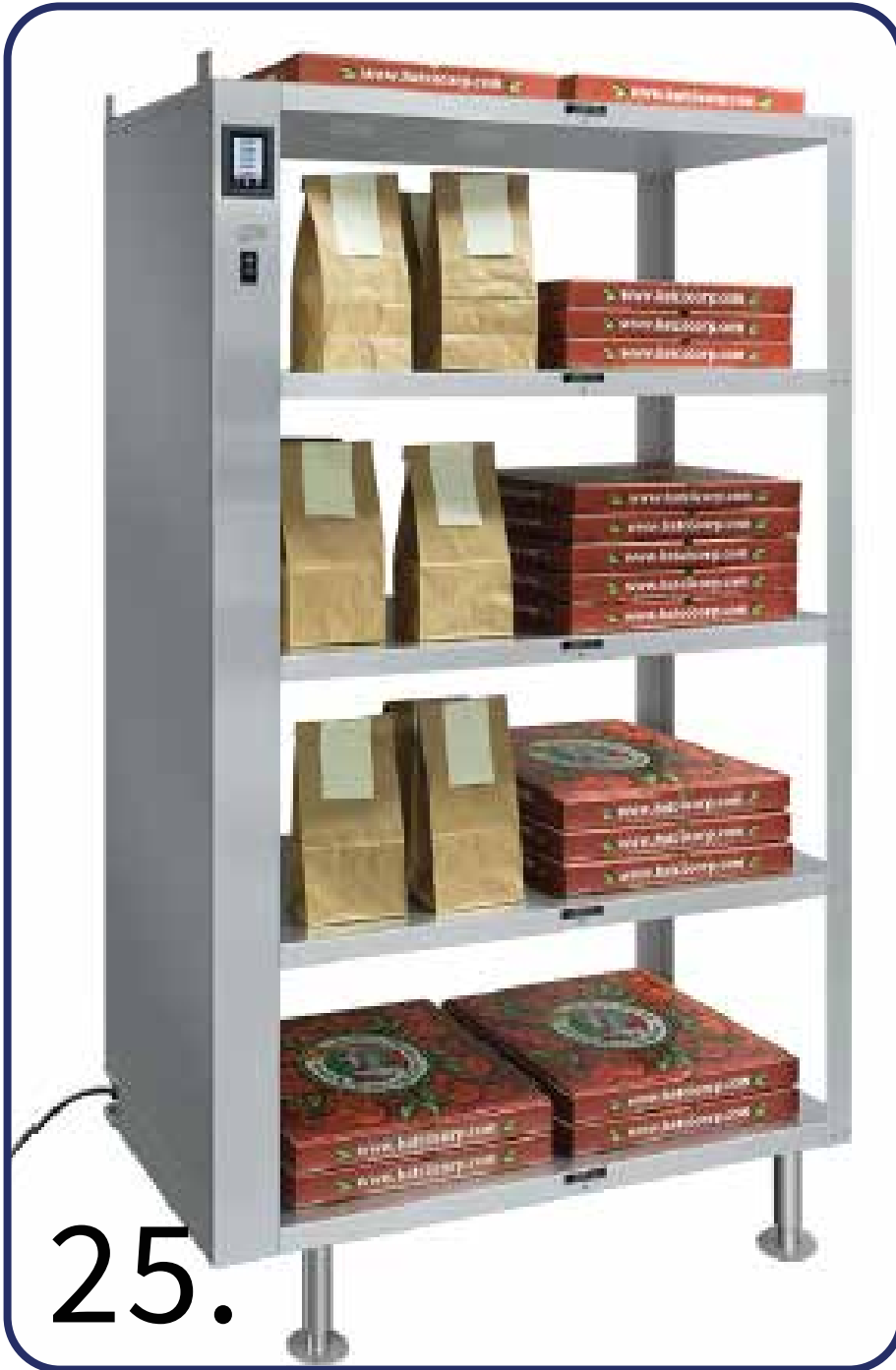

25.

Food Safety **Rule of Thumb**
Temperature Control

Flex Station & Delivery Bag/box

25. Glo-Ray 2 Go,

Heated Shelf

26. Delivery GoBag

26.



Pick-Up & Delivery



Flex Station & Delivery Bag/box

- 27. EPP Insulated Delivery Box
- 28. Delivery Pizza Bag

Temperature Control

KEEP HOT FOOD HOT

KEEP COLD FOOD COLD

Temperature Guide

Hot Food > 63°C

Cold Food < 4°C

Danger Zone, 5°C to 62°C)



28.

Pick-Up & Delivery



Glo-Ray 2-Go™ Heated Shelves

Models: GRS2G-3920-2, -3, -4, -5

The Hatco Glo-Ray 2-Go™ Heated Shelves are designed

Capable of holding a great quantity of hot food items at optimum serving temperatures, the GRS2G models hold bags and boxes up to 30 minutes with a high temperature range of up to 200 °F (93 °C).

Standard features

- A great solution to handling pick-up, third-party delivery or any food to-go situation
- Shelves are 20" (508 mm) deep and 39" (991 mm) wide, large 13" (330 mm) clearance of each shelf
- Touchscreen control with digital read out indicates separate heat and timer for each shelf
- Standard units feature shelves with heated bases that are thermostatically-controlled and have a stainless steel frame at a 45° angle
- The cord is recessed into the bottom shelf against either wall
- Optional side and back panels are one panel per shelf, giving access pass-through capabilities and leave some on for single-sided
- Unit comes with side wall mounting brackets, 6" (152 mm) x 6" (1829 mm) recessed cord and plug



Project _____

Item # _____

Quantity _____



GRS2G-3920-5
with optional side
and back panels



GRS2G-3920-4
with optional
back panels



GRS2G-3920-3
with optional
side panels



GRS2G-3920-2

Options (available at time of purchase only)

Designer Colors –

- Non-standard colors are non-returnable – Stainless Steel standard –
- Warm Red Black Gray Granite White Granite
 - Navy Blue Hunter Green Antique Copper

Controls and permanent panel on customers right side

Side panels – will be same color as unit –

- 2-shelf 3-shelf 4-shelf 5-shelf

Back panels – will be same color as unit –

- 2-shelf 3-shelf 4-shelf 5-shelf

Accessories

- 4" (102 mm) Adjustable Legs
(GRS3G-3920-2 and GRS2G-3920-3 models only)

Pick-Up & Delivery



Ready to Deliver

Cambro offers the widest variety of delivery equipment options in the industry. We'll help you design the optimal system to grow your delivery business while maintaining the food safety, flavors and textures that built your loyal following.

Food Safety and Quality

From the time the food is prepped to the moment it reaches the customer's doorstep, every second counts. Keep food safely hot or cold every step of the way.

- At-counter holding for pick-up or takeout.
- Curb side pick-up.
- Delivery.

Employee Safety

High-tech materials and ergonomic design reduce the load for employees.

- Lightweight options.
- Secure carrying straps.
- Dollies for large catering orders.

Icon Directory



Lightweight – Made of EPP (Expanded Polypropylene) an eco friendly high performance insulation material.



Chemically Inert – unaffected by oil, grease and most chemicals.



Excellent Energy Absorption – can withstand substantial impact without damage.



Great Structural Strength – capable of handling significant loads while maintaining its shape and form.



Dishwasher safe.



Safe for food contact.



100% Recyclable.

Pick-Up & Delivery



CAMBRO® GOBAGS® PROFESSIONAL GRADE INSULATED CARRIERS

Lightweight GoBags are great for single-stop deliveries of hot and cold menu items, especially pizza.

- Sturdy nylon fabric.
- High-density insulation.
- Designed to protect food quality.
- Sewn-in carrying straps.
- Minimal storage space.



CAM GOBOX® PROFESSIONAL GRADE INSULATED CARRIERS



Made of Expanded Polypropylene (EPP), an eco-friendly, high performance insulation material, Cam GoBoxes are incredibly lightweight, making delivery easy.

- Hold safe temperatures over four hours.
- Great for holding for pick-up.
- Good for multiple stops or large events.
- Stackable.
- Most economical option.



Pick-Up & Delivery



CAM GOBOX® PROFESSIONAL GRADE INSULATED CARRIERS

GN Top Loaders

A BUILT-IN LABEL AREA

Keeps optional plastic menu tags in place for easy content identification or routing. StoreSafe® Labels can also be used with Cam GoBoxes.



CAM GOBOXES
Inter-stack and also stack with major competitive brands.

LINE YOUR CAM GOBOX

With a Cambro GN Food Pan and Seal Cover for the ultimate food safety solution. Cambro GN pans protect food and carrier to support HACCP compliance.



GN Top Loader – Large Handles

OPTIONAL INSERT KIT

For an additional cold boost, use with optional Camchiller® Insert Kit EPPCTLPKG. Built-in cut-outs support cold transfer while protecting food from condensation.



ERGONOMIC HANDLES
Comfortable handles allow easy and safe lifting of the EPP180LH GoBox.

EASY LOADING AND UNLOADING

Interior wall recesses make loading and unloading easy for both GN 1/1 as well as GN 1/2 Food Pans. Straight interior walls allow room for stacking pans inside carrier.



CAM GOHEAT™

Warms to 75°C in just 10 minutes after plugging in. Place in the bottom of your insulated carrier or use to hold or display hot foods on a table top, counter or buffet.



TEMPERATURE RETENTION

4+ hours



Note: Best results will be achieved by loading food pans between 82° to 88°C. Loading metal food pans over 120°C will result in damage to the carrier.

Pick-Up & Delivery



CAM GOBOX® PROFESSIONAL GRADE INSULATED CARRIERS— GN TOP LOADERS

For Half-Size (GN 1/2) Food Pans



EPP260

Holds 1 each 15 cm deep food pan*

EXTERIOR: L 39 x W 33 x H 25,7 cm

INTERIOR: L 33 x W 27 x H 19,3 cm

UNIT WEIGHT: 0,62 kg

VOLUME: 16,9 L

Case Pack: 1 Color: Black (110).



New!

EPP280 without Strap

Holds 1 each 20 cm deep food pan*

EXTERIOR: L 39 x W 33 x H 31,6 cm

INTERIOR: L 33 x W 27 x H 25,3 cm

UNIT WEIGHT: 0,7 kg / 0,8 kg with strap

VOLUME: 22,3 L

Case Pack: 1 Color: Black (110).



EPP280BKST with Black Strap

Holds 1 each 20 cm deep food pan*

EXTERIOR: L 39 x W 33 x H 31,6 cm

INTERIOR: L 33 x W 27 x H 25,3 cm

UNIT WEIGHT: 0,7 kg / 0,8 kg with strap

VOLUME: 22,3 L

Case Pack: 1 Color: Black (110).

For Full-Size (GN 1/1) or Half-Size (GN 1/2) Food Pans



New!

EPP140

Holds 1 each 10 cm deep food pan*

EXTERIOR: L 60 x W 40 x H 20,7 cm

INTERIOR: L 53,8 x W 33,8 x H 14,5 cm

UNIT WEIGHT: 0,91 kg

VOLUME: 26 L

Case Pack: 1 Color: Black (110).



New!

EPP160 / EPP160CL with Color Lid

Holds 1 each 15 cm deep food pan*

EXTERIOR: L 60 x W 40 x H 25,7 cm

INTERIOR: L 53,8 x W 33,8 x H 19,5 cm

UNIT WEIGHT: 1,07 kg

VOLUME: 35,5 L

Case Pack: 1 EPP160 Lid Color: Black (110).
EPP160CL Lid Colors: Red (365), Orange (363),
Yellow (361), Green (360), Blue (362).



New!

EPP180 / EPP180CL with Color Lid

Holds 1 each 20 cm deep food pan*

EXTERIOR: L 60 x W 40 x H 31,6 cm

INTERIOR: L 53,8 x W 33,8 x H 25,4 cm

UNIT WEIGHT: 1,2 kg

VOLUME: 46 L

Case Pack: 1 EPP180 Lid Color: Black (110).
EPP180CL Lid Colors: Red (365), Orange (363),
Yellow (361), Green (360), Blue (362).



EPP180S

Holds 1 each 20 cm deep food pan*

EXTERIOR: L 60 x W 40 x H 31,6 cm

INTERIOR: L 53,8 x W 33,8 x H 25,4 cm

UNIT WEIGHT: 1,13 kg

VOLUME: 43 L

Case Pack: 1 Color: Black (110).



New!

EPP180XLT

Holds 1 each 20 cm deep food pan*

EXTERIOR: L 61 x W 43,1 x H 39,1 cm

INTERIOR: L 54,8 x W 36,8 x H 32 cm

UNIT WEIGHT: 1,45 kg

VOLUME: 64,5 L

Case Pack: 1 Color: Black (110).



New!

EPP180LH

Holds 1 each 20 cm deep food pan*

EXTERIOR: L 68 x W 40 x H 32,1 cm

INTERIOR: L 53,8 x W 35,5 x H 25,5 cm

UNIT WEIGHT: 1,2 kg

VOLUME: 46 L

Case Pack: 1 Color: Black (110).

*Or equivalent

Pick-Up & Delivery



CAM GOBOX® PROFESSIONAL GRADE INSULATED CARRIERS— GN FRONT LOADERS



DRIP-RESISTANT
Built-in condensation barrier helps front loaders to remain drip-resistant.



4-SIDED HANDLING
Thoughtfully designed built-in handles along the top of front loading models allow them to be easily carried from all four sides.

A BUILT-IN LABEL AREA
Keeps plastic menu tags (included with EPP300 and EPP400) in place for easy content identification or routing. StoreSafe® labels can also be used with Cam GoBoxes.

GENTLE OPEN AND CLOSE
Beveled door edges ensure door can be easily closed and latched. Durable latches for long term use.



FULL 270° ACCESS
Durable hinges and latches allow the door to open 270° and remain open securely to the side of the front loader for easy access to products. Latches keep door securely closed during transport.



STACKABILITY
Cam GoBoxes inter-stack.

TEMPERATURE MAINTENANCE TOOLS
Cam GoBox front loading carriers are designed with enough room to hold GN 1/1 Food Pans along with a Camwarmer® or Camchiller®, if desired.

TEMPERATURE RETENTION
4+ hours



Note: Best results will be achieved by loading food pans between 82° to 88°C. Loading metal food pans over 120°C will result in damage to the carrier.

Pick-Up & Delivery



CAM GOBOX® PROFESSIONAL GRADE INSULATED CARRIERS— GN FRONT LOADERS

For Full-Size (GN 1/1) Food Pans



EPP300

Holds 3 each 10 cm deep food pan*

EXTERIOR: L 64 x W 44 x H 47,5 cm

INTERIOR: L 53,5 x W 33 x H 37 cm

UNIT WEIGHT: 3,2 kg

VOLUME: 60 L

Case Pack: 1 Color: Black (110).



EPP400

Holds 4 each 10 cm deep food pan*

EXTERIOR: L 64 x W 44 x H 62,5 cm

INTERIOR: L 53,5 x W 33 x H 52,5 cm

UNIT WEIGHT: 3,9 kg

VOLUME: 86 L

Case Pack: 1 Color: Black (110).

*Or equivalent



Pick-Up & Delivery



CAM GOBOX® GN ACCESSORIES

Camchillers®

Camchillers (Cold plates) are designed to extend the cold holding time of your food. Simply freeze flat overnight and place at the top of your carrier.



CP3253

Camchiller GN 1/1 for EPP140, EPP160, EPP160CL, EPP180, EPP180CL, EPP180LH, EPP300, EPP400

L 53 x W 32,5 x H 3 cm

UNIT WEIGHT: 3,9 kg

Case Pack: 1 Color: Glacier Blue (443).



CP2632

Camchiller GN 1/2 for EPP260, EPP280, EPP280BKST, EPP280RDST

L 32,5 x W 26,5 x H 3 cm

UNIT WEIGHT: 1,75 kg

Case Pack: 1 Color: Glacier Blue (443).



HP3253

Camwarmer GN 1/1 for EPP140, EPP160, EPP160CL, EPP180, EPP180CL, EPP180LH, EPP300, EPP400

L 53 x W 32,5 x H 3 cm

UNIT WEIGHT: 3,9 kg

Case Pack: 1 Color: Fire Red (444).



New!

HP2632

Camwarmer GN 1/2 for EPP260, EPP280, EPP280BKST, EPP280RDST

L 32,5 x W 26,5 x H 3 cm

UNIT WEIGHT: 1,75 kg

Case Pack: 1 Color: Fire Red (444).

Camchiller Inserts

Built-in cut-outs support cold transfer while protecting food from condensation.



EPPCTS

Camchiller Insert for Standard EPP140, EPP160, EPP160CL, EPP180, EPP180CL, EPP180LH, EPP300, EPP400

EXTERIOR: L 60 x W 40 x H 8,7 cm

INTERIOR: L 53,7 x W 33,7 x H 3,4 cm

UNIT WEIGHT: 0,37 kg

Case Pack: 1 Color: Black (110).



EPPCTL

Camchiller Insert for EPP180LH

EXTERIOR: L 68 x W 40 x H 8,7 cm

INTERIOR: L 53,7 x W 33,7 x H 3,4 cm

UNIT WEIGHT: 0,37 kg

Case Pack: 1 Color: Black (110).

Cam GoHeat™

Warms to 75°C in just 10 minutes after plugging in. Place in the bottom of your insulated carrier or use to hold or display hot foods on a table top, counter or buffet.



New!

CGH100WUK 100W, 230V* UK
CGH200WUK 200W, 230V* UK
CGH100WEU 100W, 230V* EU
CGH200WEU 200W, 230V* EU
CGH1W12VCAR 100W, 12V - 14,2V Auto

L 49,5 x W 28,5 x H 1,2 cm

UNIT WEIGHT: 1,1 kg

Case Pack: 1 Color: Silver (486).

*220-240 volt alternating current.

Camchiller Insert Kits



EPPCTSPKG110

Standard top loader Camchiller and Insert all in one package, available for EPP180 and EPP160.



EPPCTLPKG110

Large handle Camchiller and Insert all in one package, available for EPP180LH.

ThermoBarrier®

Designed to keep hot or cold air concentrated within your front-loading carrier. As food pans are being removed, use the ThermoBarrier to close up any open space created.



EPP3253DIV

ThermoBarrier fits EPP300 and EPP400

L 53 x W 32,7 x H 3,7 cm

UNIT WEIGHT: 0,37 kg

Case Pack: 1 Color: Black (110).

Pick-Up & Delivery



CAM GOBOX® GN ACCESSORIES

Color Lids

Use lids to color code for quick content identification or routing.



EPP3253LID

Color lid for EPP140, EPP160, EPP160CL, EPP180, EPP180CL, EPP180S

L 60 x W 40 x H 3,4 cm

UNIT WEIGHT: 0,28 kg

Case Pack: 1 Colors: Cambro Red (365), Orange (363), Yellow (361), Green (360), Cold Blue (362), Black (110).

Camdolly®



CD3253EPP

Camdolly fits GN 1/1 Cam GoBoxes 4 swivel casters, 2 with brake

EXTERIOR: L 69,2 x W 42,6 x H 16,7 cm

INTERIOR: L 61,8 x W 41 cm

UNIT WEIGHT: 4,5 kg

LOAD CAPACITY: 250 kg

OPTIONAL TRANSPORTING STRAP:
400STP, 381 cm long strap

Case Pack: 1 Camdolly Color: Hot Red (158).
400STP Color: Beige (000).

Plastic ID Labels



EPPID5

Plastic ID labels fits all Cam GoBoxes

Case Pack: 1 Color: (000).

CAM GOBOX® CAPACITY GUIDE

EPP140 (GN 1/1) EPP160 (GN 1/1) & EPP260 (GN 1/2)

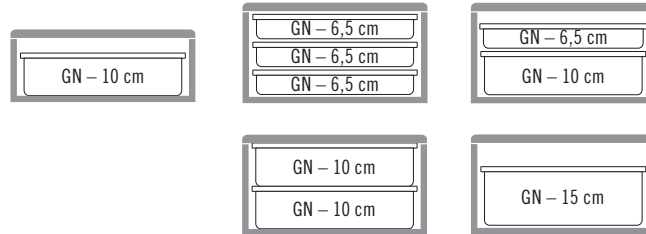

EPP180 (GN 1/1) & EPP280 (GN 1/2)

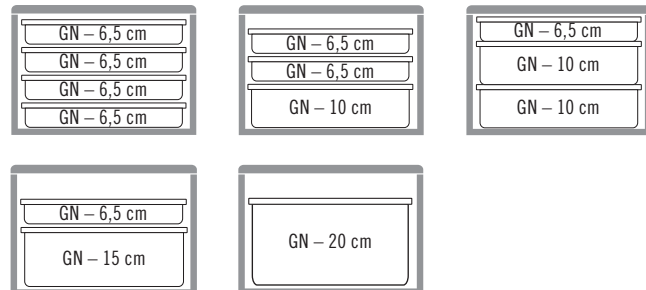

EPP180S

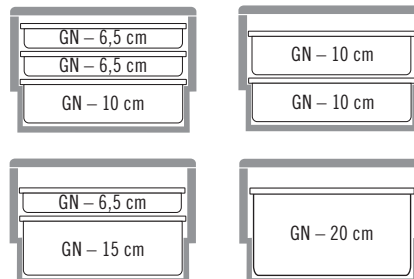

Unique design allows inter-stacking, saving 30% storage space.

EPP300 (GN 1/1)

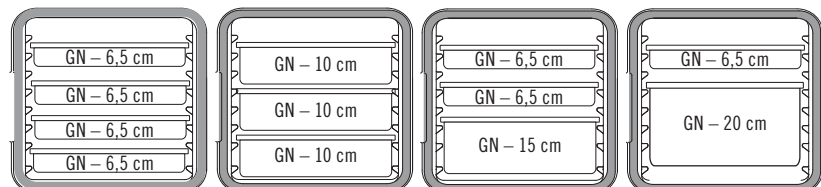

EPP400 (GN 1/1)

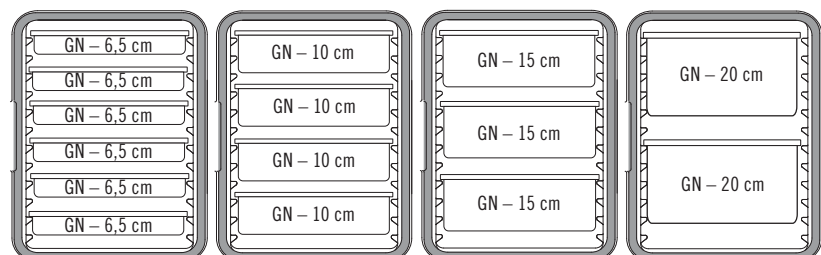

Pick-Up & Delivery



CAM GOBOX® 4060 PROFESSIONAL GRADE INSULATED CARRIERS— MULTI-PURPOSE FRONT LOADER – 60 X 40 CM

STACKABILITY

Cam GoBoxes inter-stack and also stack with major competitive brands.

EASY IDENTIFICATION

A built-in label area keeps plastic menu tags in place for easy content identification or routing. Dissolvable StoreSafe® Labels can also be used with Cam GoBoxes.

FULL 270° ACCESS

Durable hinges and latches allow the door to open 270° and remain open securely to the side of the front loader for easy access to products. Latches keep door securely closed during transport.



4-SIDED HANDLING

Thoughtfully designed, built-in handles along the top of the front loader units allow them to be easily carried from all four sides.

UNIQUE DESIGN

Compartment for cold chiller plate or hot plate is located on the inner back wall to prevent overhead condensation drips and to evenly distribute temperature throughout the carrier.

GENTLE OPEN AND CLOSE

Beveled door edges ensure door can be easily closed and latched. Durable latches for long term use.

DRIP-RESISTANT

Built-in condensation barrier helps front loaders to remain drip-resistant.



Front Loaders With Built-In Rails

Front-loading carriers with built-in rails are designed to hold 60 x 40 cm pans, sheet pans and trays securely in place during transport.



EPP4060F6R

Carrier with 6 Built-in Rails

EXTERIOR: L 77 x W 54 x H 68,7 cm

INTERIOR: L 61,5 x W 41 x H 58,5 cm

RAIL SPACING: 6 cm

UNIT WEIGHT: 6,34 kg

VOLUME: 126 L

Case Pack: 1 **Color:** Black (110).



EPP4060F9R

Carrier with 9 Built-in Rails

EXTERIOR: L 77 x W 54 x H 68,7 cm

INTERIOR: L 61,5 x W 41 x H 58,5 cm

RAIL SPACING: 3,5 cm

UNIT WEIGHT: 6,6 kg

VOLUME: 126 L

Case Pack: 1 **Color:** Black (110).

TEMPERATURE RETENTION

4+ hours



Note: Best results will be achieved by loading pans between 82° to 88°C. Loading metal pans over 120°C will result in damage to the carrier.

Pick-Up & Delivery



CAM GOBOX® PROFESSIONAL GRADE INSULATED CARRIERS—

FRONT LOADER – 60 X 40 CM

Front Loader without Rails

Multi-purpose carrier with no molded-in rails is designed for transporting 60 x 40 cm crates filled with wrapped, prepackaged foods. This carrier can also be modified for versatility to include optional, stainless steel adjustable rails, EPP4060FPR1*, for transporting a combination of 60 x 40 cm crates, baking pans and trays all in the same carrier.



EPP4060FNR

EXTERIOR: L 77 x W 54 x H 68,7 cm

INTERIOR: L 61,5 x W 41 x H 58,5 cm

UNIT WEIGHT: 6,1 kg

VOLUME: 155 L

Case Pack: 1 **Color:** Black (110).

*Additional rails can be purchased separately. See accessories page.

Front Loader with Adjustable Rails

The multi-purpose carrier with adjustable rails is designed with 2 sets of stainless steel adjustable rails.* This exclusive design provides the operator with maximum flexibility to transport a combination of 60 x 40 cm crates, baking pans and trays all in the same carrier.



EPP4060FADJR

EXTERIOR: L 77 x W 54 x H 68,7 cm

INTERIOR: L 61,5 x W 41 x H 58,5 cm

UNIT WEIGHT: 8,17 kg

VOLUME: 155 L

Case Pack: 1 **Color:** Black (110).

*Additional rails can be purchased separately. See accessories page.



Pick-Up & Delivery



CAM GOBOX® 4060 PROFESSIONAL GRADE INSULATED CARRIERS— TOP LOADERS FOR 60 X 40 CM CRATES

Top loading 60 x 40 cm carriers are lightweight and designed to keep hot or cold food out of the danger zone for 4+ hours. Designed to transport bakery crates and more, 60 x 40 GoBoxes even have room for a cold plate Camchiller® or hot plate Camwarmer® to enhance temperature retention. Ergonomic, recessed handles for convenient carrying and transporting.



Cam GoBoxes inter-stack and also stack with major competitive brands.

Recessed handles ease carrying and storage.

A built-in label area keeps optional plastic menu tags in place for easy content identification or routing. StoreSafe® Labels can also be used with Cam GoBoxes.



EPP4060T200

20 cm Deep Top Loader

EXTERIOR: L 69 x W 49 x H 27 cm

INTERIOR: L 62,5 x W 42,5 x H 20,5 cm

UNIT WEIGHT: 1,4 kg

VOLUME: 53 L

Case Pack: 1 **Color:** Black (110).



EPP4060T300

30 cm Deep Top Loader

EXTERIOR: L 69 x W 49 x H 37 cm

INTERIOR: L 62,5 x W 42,5 x H 30,5 cm

UNIT WEIGHT: 1,7 kg

VOLUME: 80 L

Case Pack: 1 **Color:** Black (110).



TEMPERATURE RETENTION

4+ hours



Note: Best results will be achieved by loading pans between 82° to 88°C. Loading metal pans over 120°C will result in damage to the carrier.

Pick-Up & Delivery



CAM GOBOX® 4060 ACCESSORIES

Camchiller®

Camchiller (Cold plate) is designed to extend the cold holding time of your food. Simply freeze flat overnight and place at the top of your top-loading carrier or at the back of your front-loading carrier.



CP3253

Camchiller GN 1/1 fits all Cam GoBoxes 4060

L 53 x W 32,5 x H 3 cm

UNIT WEIGHT: 3,9 kg

Case Pack: 1 **Color:** Glacier Blue (443).

Camwarmer®

Camwarmer (Hot plate) is designed to extend the hot holding time of your food. Place in a hot water bath for 40 minutes and place at the bottom of your top-loading carrier or at the back of your front-loading carrier.



HP3253

Camwarmer GN 1/1 fits all Cam GoBoxes 4060

L 53 x W 32,5 x H 3 cm

UNIT WEIGHT: 3,25 kg

Case Pack: 1 **Color:** Fire Red (444).

Adjustable Rail Kit for EPP4060FNR

Stainless Steel frames and 2 sets of rails are designed to offer the operator the flexibility to adjust and create custom spaces as needed in-between the rails.

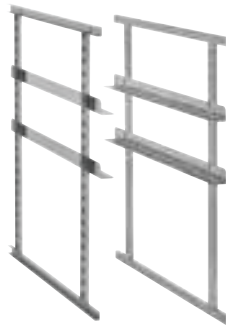

EPP4060FPR1

Stainless Steel frames and 2 sets of rails

L 60 x W 1 x H 58 cm

UNIT WEIGHT: 2,07 kg

Case Pack: 1 **Color:** Silver (000).

Cam GoHeat™

Warms to 75°C in just 10 minutes after plugging in. Place in the bottom of your insulated carrier or use to hold or display hot foods on a table top, counter or buffet.



CGH100WUK 100W, 230V* UK
CGH200WUK 200W, 230V* UK
CGH100WEU 100W, 230V* EU
CGH200WEU 200W, 230V* EU
CGH1W12VCAR 100W, 12V - 14,2V Auto

L 49,5 x W 28,5 x H 1,2 cm

UNIT WEIGHT: 1,1 kg

Case Pack: 1 **Color:** Silver (486)

*220-240 volt alternating current.

Kit of Rails for EPP4060FPR1

Kit of 2 adjustable stainless steel rails can be purchased separately to transport more items within the same carrier.



EPP4060FAR

Kit of 2 adjustable stainless steel rails

L 60 x W 3 x H 3 cm

UNIT WEIGHT: 0,42 kg

Case Pack: 1 **Color:** Silver (000).

Camdolly® for Cam GoBoxes 4060



CD4060EPP

Camdolly fits Cam GoBoxes 4060
 4 swivel casters, 2 with brake

EXTERIOR: L 71 x W 51 x H 16,7 cm

INTERIOR: L 70 x W 50 cm

UNIT WEIGHT: 5,27 kg

LOAD CAPACITY: 250 kg

Case Pack: 1 **Color:** Hot Red (158).

Plastic ID Labels



EPPID5

Plastic ID labels fits all Cam GoBoxes

Case Pack: 1 **Color:** (000).

Pick-Up & Delivery



New!

CAM GOBOX® PROFESSIONAL GRADE INSULATED CARRIERS— TOP-LOADING PIZZA CARRIER

Vent releases steam to keep crust crispy.



Holds 33 x 33 cm pizza boxes.



Available in four different heights that hold from two to eight pizzas.



EPPZ35100 without Strap
Cam GoBox Pizza Top Loading Carrier 10 cm Tall
EXTERIOR: L 41 x W 41 x H 17,4 cm
INTERIOR: L 35 x W 35 x H 10 cm
UNIT WEIGHT: 0,68 kg
CAPACITY*: 2 pizzas
Case Pack: 1 **Color:** Black (110).



EPPZ35175 without Strap
EPPZ35175BST with Black Strap
EPPZ35175RST with Red Strap
Cam GoBox Pizza Top Loading Carrier 17,5 cm Tall
EXTERIOR: L 41 x W 41 x H 24,9 cm
INTERIOR: L 35 x W 35 x H 17,5 cm
UNIT WEIGHT: 0,82 kg / 0,89 kg with Strap
CAPACITY*: 4 pizzas
Case Pack: 1 **Carrier Color:** Black (110).



EPPZ35265 without Strap
EPPZ35265BST with Black Strap
EPPZ35265RST with Red Strap
Cam GoBox Pizza Top Loading Carrier 26,5 cm Tall
EXTERIOR: L 41 x W 41 x H 33,9 cm
INTERIOR: L 35 x W 35 x H 26,5 cm
UNIT WEIGHT: 1 kg / 1,07 kg with Strap
CAPACITY*: 6 pizzas
Case Pack: 1 **Carrier Color:** Black (110).



EPPZ35330 without Strap
EPPZ35330BST with Black Strap
EPPZ35330RST with Red Strap
Cam GoBox Pizza Top Loading Carrier 33 cm Tall
EXTERIOR: L 41 x W 41 x H 40,4 cm
INTERIOR: L 35 x W 35 x H 33 cm
UNIT WEIGHT: 1,23 kg / 1,3 kg with Strap
CAPACITY*: 8 pizzas
Case Pack: 1 **Carrier Color:** Black (110).

TEMPERATURE RETENTION

4+ hours

*With 33 x 33 x 4 cm Pizza Box.



Pick-Up & Delivery



CAM GOBOX® PROFESSIONAL GRADE INSULATED CARRIERS— BEVERAGE CARRIER, CUP HOLDER AND EPP280 WITH STRAP

New!



EPPBEVBKST



EPPBEVRDST

Designed to hold 12-750 mL tall items such as wine bottles or 12-1,5 liter plastic bottles.



EPP280RDST

Comes with convenient, plastic carrying strap.

Beverage Carrier



EPPBEVBKST with Black Strap
EPPBEVRDST with Red Strap

EXTERIOR: L 42 x W 33,5 x H 42 cm

INTERIOR: L 35,8 x W 27,3 x H 36,7 cm

UNIT WEIGHT: 1,02 kg

CAPACITY: 35 L

Case Pack: 1 **Carrier Color:** Black (110).

EPP280 with Strap



EPP280BKST with Black Strap
EPP280RDST with Red Strap

EXTERIOR: L 39 x W 33 x H 31,6 cm

INTERIOR: L 33 x W 27 x H 25,3 cm

UNIT WEIGHT: 0,8 kg

CAPACITY: 22,3 L

Case Pack: 1 **Carrier Color:** Black (110).

Beverage Cup Holder

Modular beverage holder for transporting hot or cold drinks with ease. Interlocking units connect to hold up to 15 drinks in an EPP180. Holds 350 to 750 mL hot or cold cups.

CODE	DESCRIPTION	DRINK CAPACITY
EPPBEVH1	single holder	3
EPPBEVH2	set of 2 holders	6
EPPBEVH5	set of 5 holders	15
Exterior Dim.: L 11,4 x W 32,5 x H 12,5 cm		
Case Pack: 1 Color: Black (110).		

Compartments are tapered to fit multiple cup sizes: 7,1 cm at bottom graduates to 8,9 cm at the top.



TEMPERATURE RETENTION
4+ hours



GOBOX CODE	NUMBER OF DRINKS	NUMBER OF HOLDERS
EPP180	15 (single layer*)	5 (single)
	30 (double layer**)	10 (double)
EPP160	15	5
EPP140	15	5
EPP280	6	2
EPP260	6	2

*Single layer only recommended for hot cups. Use with Beverage Plugs to prevent spilling during transport.

**Double layer possible only with 350 mL or smaller cups.

Pick-Up & Delivery



New!

CAM GOBOX® PROFESSIONAL GRADE INSULATED CARRIERS— MULTIPURPOSE TOP LOADER



Cam GoBoxes inter-stack and also stack with major competitive brands.



Designed to hold disposable dishware or 5 liter Gelato pans.

EASY LOADING AND UNLOADING
Interior wall recesses make loading and unloading easy for both GN 1/1 as well as GN 1/2 Food Pans. Straight interior walls allow room for stacking pans inside carrier.

A built-in label area keeps optional plastic menu tags in place for easy content identification or routing. StoreSafe® Labels can also be used with Cam GoBoxes.

Recessed handles ease carrying and storage.



EPP180X

For Disposable Sealed Dishes and Gelato Pans 20,5 cm deep

EXTERIOR: L 61 x W 43 x H 27 cm

INTERIOR: L 54,8 x W 36,8 x H 20 cm

UNIT WEIGHT: 1,18 kg

VOLUME: 41 L

Case Pack: 1 **Color:** Black (110).



EPP180XL

For Disposable Sealed Dishes and Gelato Pans 25 cm deep

EXTERIOR: L 61 x W 43 x H 32 cm

INTERIOR: L 54,8 x W 36,8 x H 25 cm

UNIT WEIGHT: 1,33 kg

VOLUME: 50,5 L

Case Pack: 1 **Color:** Black (110).



EPP180XLT

For Disposable Sealed Dishes and Gelato Pans 32 cm deep

EXTERIOR: L 61 x W 43 x H 39 cm

INTERIOR: L 54,8 x W 36,8 x H 32 cm

UNIT WEIGHT: 1,45 kg

VOLUME: 64,5 L

Case Pack: 1 **Color:** Black (110).

Disposable Dishes Holding Capacity



CAM GOBOXES	18 x 18 x 3 CM	19 x 20 x 6 CM	GN 1/1 FOOD PAN 10 CM DEEP
EPP180X	24	24	2
EPP180XL	30	42	3
EPP180XLT	42	48	4

TEMPERATURE RETENTION

4+ hours

Gelato holds for 1 hour.

