

LCS CATALOG 2017/18



Solutions for
**HOTELS, RESTAURANTS, HEALTHCARES, CATERINGS
& FOOD SERVICES**



ONE STOP HARD WORK

HONESTY OPEN DOOR POLICY

FLEXIBLE QUALITY CUSTOMER SERVICE

TRUST ONSITE SUPPORT

UNDERSTANDING

FRIENDSHIP FULL OF

HUMOROUS WORK LIFE

BEING RESPONSIBLE

CUSTOMER LOYALTY SUPPORTIVE

CUSTOMIZED MORE

ON-SITE SUPPORT FAIR

BEING ETHICAL FAMILY

HUMOROUS WORK HARD,

AMBITIOUS



1948

"Lau Choy Seng, 劉再成" was established on 10 October, 1948 by Mr. Lau Chew Tat, with a vision of to be successful as it spells in the Chinese characters. Mr. Lau Chew Tat started the business for wooden chop making in a small shop along Temple Street, Singapore.



1960s

Shop relocated to 38 Temple Street, and continued its business. Mr. Lau Swee Hong, son of Mr. Lau Chew Tat joined the company at the 1960s.



1970s

In view of the potential in Food & Beverages Industry, the business started to diversify. Lau Choy Seng remained into kitchenware supply and mainly focused on Chinese Kitchens.



Lau Choy Seng began to sell export kitchenware from Hong Kong by the late of 70s in order to provide quality products at competitive price to the growing client base.

1990

Lau Choy Seng expanded again and rented a new warehouse at 20 Penjuru Road, 8,000 sqft. Lau Choy Seng has experienced many changes over the last few decades. Due to the paradigm shift the business grew in leaps and bounds.



1993

Lau Choy Seng relocated the retail outlet to 23 & 25 Temple Street that occupied two units of retail shop lots. A wider range of Chinese Kitchen Equipment added to the portfolio. Lau Choy Seng operated only with 1 van for delivery and 2 staffs.



As year continues client base grew even stronger. Lau Choy Seng moved towards supply and service from hotels to chain restaurants, from catering to institutional facilities and individual F&B outlet to walk-in retail.

2000s

Lau Choy Seng continued to seek for new opportunities, at the year of 2006 a significant progression- Lau Choy Seng first project established in Holiday Inn, Malacca - to supply internationally. Followed by few local major projects includes St. Regis Singapore, Resorts World & Marina Bay Sands.



1999

Due to the demands in F&B industry, Lau Choy Seng further expanded the warehouse from 8,000 to 20,000 sqft located at 86, Tuas West Avenue 11. This is to ensure that Lau Choy Seng being able to cater to meet requirements and needs from the clientele.



2007

Lau Choy Seng further expanded the warehouse from 20,000 to 45,000 sqft at 30 Tuas West Ave 11.

2010

Lau Choy Seng is now direct distributor and stockist for more than 35 brands and have over 20,000 products in our stock list for Tableware, Barware, Cutlery, Chinese, Japanese and Western kitchenware, Food Service equipment. In addition, we also produce house



brand of quality stainless steel pots and pans, Chinese kitchen knives and tools, kitchen equipments, chef coats, umbrellas and aprons.

2015

Today, Lau Choy Seng established a new branch office & showroom in Malaysia, named LCS Hospitality Solutions Sdn Bhd in order to service the growing clientele better.



Contents

1.

Cookware

Bain Marie	52-53
Casserole & Pans, Cast Iron	44-46
Cooking Pots & Pans, Affinity	37-38
Cooking Pots & Pans, Aluminum	21
Cooking Pots & Pans, 3 Ply	14-15
Cooking Pots & Pans, 5-Stelle	10-11
Cooking Pots & Pans, Chef Series	12-13
Cooking Pots & Pans, Gourmet Steel	19-20
Cooking Pots & Pans, Ozti	16-18
Cooking Pots & Pans, Risoli	40-42
Copperware, Induction	30-32
Copperware, Inocuisse	33-35
Fish Kettle	29
Food Pans, Gourmet Steel 188	47-48
Food Pans, Gourmet Steel 201	49-51
Food Pans, High Heat	57-58
Food Pans, Polycarbonate	54-56
Food Pans, Polypropylene	59-62
Frying Pan	22-28
Frying Pan, Accessories	28-29

2.

Kitchenware

Aluminum Foil	130
Baking Tray	66-67
Cherry Stoner	116
Chill Bat	91
Cling Film	130
Condiment Container	68-70
Condiment Shaker	70
Cream & Soda Siphon Whipper	128-129
Decorating Tools & Garnishing Set	119
Digital & Weighing Scale	102-105
Food Mill	126
Food Tong, Stainless Steel	101
French Fry Cutter	125
Fry Basket	76
Gas Lighter & Blow Torch	111
Grater & Zester	120-122
Grill Wire Rack	68
Hamburger Press	126

Ice Cream Scoop & Gelato Spade	93-95
Ice Scoop	91-92
Juice Press	127
Kitchen Timer	110
Measuring Cup & Jug	90-91
Melon Baller & Coring Tools	117-118
Mixing Bowl & Colander	71-72
Nut Cracker	115
Oil & Piston Funnel	92
Pastry Brush	112
Pastry Wheels	120
Peeler, Slicer & Wedger	113-115
PH Meter	108
Pizza Cutter	120
Potato Masher	114
Rectangular Tray	64
Rice Scoop & Soup Ladle	83
Roasting Pan	65
Roller Cutter & Mandoline	124-125
Salad Spinner	127
Salt Refractometer	108
Serving Spoon & Fork	86-87
Serving Tongs, Stainless Steel	96-98
Spoodle & Basting Spoon	84-85
Strainer & Skimmer	73-76
Sugar Refractometer	107
Tasting Spoon	96
Thermometer	109-110
Thermometer, Digital & Probe	106-107
Tongs, Polycarbonate	99
Turner & Spatula	78-82
Tweezer & Pincer	95-96
Utility Tong, High Temp & Heavy Duty	100-101
Vegetable Slicer	123
Whisk	88-90

3.

Knives

Apron	164
Bone Saw	164
Can Opener, Electric	173
Can Opener, Manual	174
Can Opener, Table Mounted	172-173
Chopping Board Stand & Working Table	175
Chopping Board, Wooden	174
DEXTER Cut Resistance Glove	163
DEXTER Knife Guard	163
DEXTER Knife	165
Electric Knife Sharpener	167
Fish Scaler	180
Ham Vice	180
IVO BLACKMASTER Block	155
IVO BLADEMASTER	141-143

IVO Butcher Glove	163
IVO Dicing Knife	160
IVO EURO POULTRY	156
IVO FUKUI	139-140
IVO Knife Bag	162-163
IVO Knife Set	160-161
IVO PROFESSIONAL LINE	145-150
IVO PROMASTER Block	155
IVO SOLO	152-154
IVO VIRTUBLACK	135-137
IVO VITRUGOLD	133,159
IVOCHEESE	157
Kitchen Scissor	171
Knife Holder	169
Knife Sterilizer	169
Meat Tenderizer	177-178
Oyster Knife	170
Oyster Opener	170
Pincer & Tweezer	178
Plier & Tong	179
Poultry Shear	171
Rectangular Cutting Board, PE	176-177
Round Cutting Board, Plastic	175
Sharpening Steel	166
Sharpening Stone	167-168

4.

Pastry

Cream Mould	201
Loaf Pan, Non-Stick	233-234
Aluminium Mould	237-238, 242
Aluminium Muffin Pan	225
Automatic Piston Funnel & Stand	216
Baker's Blade	203
Baking Mat & Baking Sheet	225
Baking Paper, Non-Stick	225
Baking Tray	221-224
Biscuits Sheet, Stainless Steel	229
Blow Torch	288
Bread Basket	226
Bread Pan, Blue Steel	229-230
Brine density Meter	290
Cake Divider & Slicer	202
Cake Pan, Hard Anodized	236
Cake Roll Pan, Blue Steel & Non-Stick	230
Cake Roll Pan, Tinplated	228
Cake Stand	287
Camdolly for Dough Box	227
Chocolate Moulding Machine	294
Chocolate Moulds	274
Chocolate Praline Mould	297-300

Contents

Pan Fried Trolley	370
Paper Cake Cup	351
Pastry Brush	353
Pastry Cutter, Stainless Steel	347-351
Piano Whip	354
Pipping Nozzle & Bag	353
Plastic Container	371-372
Porridge Cooker	364
Porridge Trolley	370
Pots & Pans	304-307
Prata Pan	310
Pressure Cooker	308
Rice Cooker	367
Rice Warmer	367
Roast Duck Oven	335
Roasted Meat Trolley & Rack	336
Rolling Pin	352
Round Ice Mould	357
Salamander	365
Salt & Pepper Shaker	319
Satay Stick	322
Sharkfin Bowl	358
Sharkfin Fin Net	321
Sharpening Stone	330
Skimmer & Skimmer Ring	314
Soup Bag & Basket	315
Soup Warmer	367
Stackable Container	373-374
Steam Pan	317
Steam Pao Paper	343
Steam Plate, Stainless Steel	343
Steamer & Cover, Stainless Steel	320-321
Stone Bowl	361
Stool for Chinese BBQ	335
Storage Container with Cover	372
Strainer	311-313
Table Top Bain Marie	335
Table Top Griddle	365
Tart & Pastry Oven	364
Tim Sum Paper	342
Tim Sum Scale	342
Triangle Shape Rack	341
Utility Tray/Plastic Colander	375
Vegetable Carving Tools	341
Vegetable Chop Knife	325-326
Water Heater	366
Water Pail/Bucket	354
Wok Brush	311
Wok Ring	310
Wooden Sashimi Boat	357
Yam Cake Flyer	346

6. Japanese Kitchen

Aluminium Cooking Pots & Pan	380
Bamboo Leaf Shape Plate	403
Bamboo Pick & Skewer	393
Bamboo Turner	383
Bento Box	395-397
Condiment Container, Stainless Steel	391
Cooking Furnace	379
Copper Frying Pan	380
Crab Scissor	392
Donburi Pan	381
Food Warmer	378
Gas Cartridge Stove	379
Hanging Pot	378
Ice Mould, Plastic	394
Iron Wok with Handle	381
Japanese Knife	386-387
Kitchen Scissor	392
Lacquer Soup Bowl	402
Lacquer Tray & Plate	399-400
Miso Soup Bowl	401
Nabe Plier/Tong	381
Noodle Strainer	391
Nori Box	385
Oyster Opener	389
Pastry /Oil Brush	383
Peeler	392
Pincer & Tweezer	389
Raddish Grater	390
Rice Cloth	382
Rice Container with Cover	403
Rice Scoop, Plastic	383
Sashimi Boat	394
Sashimi Chopstick	385
Sauce Container	383
Sharpening Stone	388
Soba Sauce Cup	401
Soba Tray & Bamboo Mat	398
Solid Cube Heating Fuel	379
Soup Spoon/ Ladle	391
Steamboat Ladle	391
Steamer, Stainless Steel	381
Sushi Basin, Wooden	382
Sushi Container	382
Sushi Handroll Stand	403
Sushi Maker	385
Sushi Mat	385
Sushi Mould	384-385
Sushi Rice Ladle	383
Sushi Tray	403-404

Tako Ball Picker & Oil Brush	381
Tempura Chopstick	390
Tempura Pan	380
Tempura Strainer	390
Tofu Tray	381
Towel Tray	403
Vegetable Colander	390
Vegetable Slicer	388
Wire Net	379
Wooden Service Tray	399

7.

Equipment

Bar Blender	440-441, 443
BBQ Garden Griller	482
Blanco Cook Mobile System	526-543
Bone Saw	479
Bread Toaster, Conveyer	492-493
Bread Toaster, Slot	494-495
Burger Patty Machine	480
Burner Griller	483-484
Centrifugal Juice Extractor	447
Cheese Grater, Electric	470
Cheese Melter	460
Chocolate Fountain	454-457
Citrus Juicer	444-445
Coffee /Tea Urn	464
Coffee Maker/Percolator	465
Coffee Warmer & Decanter	465
Cold Press Juicer	448
Convention Oven, Electric	496
Crepe Maker, Electric	489-490
Cutlery Dryer	524
Deep Fryer	481,541
Dehydrator	460
Display Warmer	513-514
Doner Grill & Slicing Machine	488
Dough Mixer, Electric	466-469
Drink Dispenser	462
Food Display Steamer	514
Food Serving Trolley	515
Food Slicer	438
Freestanding Drawer Warmer	514
Freezer/ Chiller	452
Gas Planetary Wok Cooker	511
Gas Stove	508-510
Glass Dryer, Electric	525
Glass Washer	524
Griller	485
Hand Blender	435
Heated Glass Display Warmer	512
Heating Lamp & Carving Station	517-522
Hot Towel Box	523

Contents

Hot Water Urn / Water Heater	462-463
Hotdog & Bread Warmer, Electric	491
Hotdog Roller Grill, Electric	492
Hotplate, Domestic	508
Ice Block Shaver	450-451
Ice Cube Crusher & Shaver	449-450, 451-452
Induction Cooker	506-508
Induction Warmer	504-505
Infrared Radiator Bulb	522
Infrared Strip Heater	516
Kitchen Blender	441,444
Manual Salad Spinner	438
Meat Mincer	477-478
Meat Mixer	478
Meat Slicer	474-476
Meat Tenderizer	480
Microwave Oven	498-499
Milkshake Drink Mixer	439
Orange Juicer	445-446
Pacojet Food Processor & Accessories	453
Panini Contact Grill, Electric	486-488
Pasta Cooker	541
Pasta Machine	471-472
Pasta/Noodle Machine	473
Pizza Oven, Electric	497
Potato Peeling Machine	437
Refrigerated Cold Display Shelf	512
Rice Cooker	500-501
Rice Warmer	502-503
Robot Coupe, Food Processors: Cutters & Vegetable Slicer	406-409
Robot Coupe, Power Mixers	428-434
Robot Coupe, Robot Cook	420-421
Robot Coupe,	
Table Top Cutter Mixers	416-417
Robot Coupe,	
Vegetable Preparation Machines	410-415
Robot Coupe,	
Vertical Cutter Mixers	418-419
Robot Coupe, Blixer	422-425
Robot Coupe, Food Processor	436
Robot Coupe, Discs Collection & Accessories	426-427
Rolling Machine	469
Round Heated Well Soup Warmer	515
Salamander	483
Sandwich Grill, Electric	486
Sandwich Toaster, Electric	491,496
Sausage Stuffer/Filler	478
Slush Machine	462
Smoking Gun	459
Soft Cooker	458
Steam Warmer	515
Stick Blender	435
Sushi Machine, Electric	499

Table Top Griddle	485
Thermal Blender, My Cook	459
Thermal Blender, Thermomix	459
UV Knife Sterilizer, Electric	523
Vacuum Sealing Machine	461
Volcanic Char-Rock	482
Waffle Maker, Electric	490-491

8.

Storage & Transport

Aprons, Disposable & PVC	639
Banquet Trolley	562 - 563
Banquet Trolley, Blanco	558 - 561
Bath Mat	663
Broom Nylon	649 - 650
Bus Boxes	624
Cigarette Butt Bin	664 - 665
Cleaning Cart	663
Closet Organizer	652
Cover For Trollies, Canvas	602
Cover For Trollies, Disposable	602
Cube Truck	660 - 661
Disposable Gloves, Latex	639
Disposable Gloves, Nitrile	639
Disposable Gloves, Vinyl	639
Dunnage Rack	590
Dustbin, Brute, Slim Jim,	653 - 659
Dustbin, Mobile	658 - 659
Dustbin, Pedal	655 - 659
Dustpan	650
EPP Insulated Boxes, Cambro	546 - 549
EPP Insulated Boxes, Kangka	564
Face Mask	639
Flat Ware Basket	624
Floor Metal Brush & Scraper	651
Floor Squeegee	651
Floor Sweep	649
Food Storage Boxes	572 - 574
Food Storage Container, Round	570 - 571
Food Storage Container, Square	568 - 569
Food Storage Stackable Container	579 - 581
Food Storage Tupperware	577 - 578
Glass brushes	652
Glass Racks, Cambro	616 - 623
Glass Racks, Unica	625 - 631
Housekeeping Cart	663
Ice Caddies, Insulated	565
Ice Transport Porter	565
Ingredient Bin	575 - 576
Insulated Transport Boxes	550 - 557

Lobby Bin	665
Mop Cotton & Handle	642
Mop, Dust Mop & Handle	643 - 645
Mop, Press & Wringer	647
Oven Grill Brush	637
Pizza Dough Boxes	575
Plate Caddies, Adjustable	613 - 614
Plate Caddies, Fixed	615
Plate Dispensing Trolley	562
Plate Dispensing Trolley, Blanco	561
Plate Stacking Trolley, Blanco Servistar	566
Plate Stacking Trolley, Jackstack	567
Rubber Gloves	638
Safety Shoes	640
Safety Signage	648
Scrub Brushes	652
Shelving, High Density Mobile	592 - 599
Shelving, Wall Mount	590
Shelving's, Basic Series	588 - 589
Shelving's, Element Series	582 - 587
Shortening Monitor	636
Signage Acrylic	666 - 667
Sponges & Pads	632 - 634
Spray, Pressure	636
Stainless Steel Polish	636
Step Stools & Ladder	662
Tilt Truck	660 - 661
Toilet Brush	651
Towels, Kitchen	635
Towels, Microfibre	635
Transport Dolly	603
Transport Trolley, S/Steel 18" x 26" Tray	602
Transport Trolley, S/Steel 40 x 60 Tray	601
Transport Trolley, S/Steel GN Size	600 - 601
Tray & Dish Cart	609
Trolley Platform	612
Trolley Utility, Heavy Duty	610 - 611
Trolley, 2 & 3 Tier Plastic	605 - 608
Trolley, 2 & 3 Tier S/steel	603 - 604
Water Boots	641

9.

Bar

9.BAR	
Ashtray	687
Bamboo Basket	689
Bar & Shelf Textliner	683
Bar Blender	708-710
Bar Caddy	683

Contents

Bar Spoon	674,678
Boston Shaker	673
Bottle Opener	675-676
Bottle Stopper, Plastic	681
Champagne Bucket	696-697,700
Champagne Pump Stopper	681-682
Citrus Juicer	711
Cleaning Beads	682
Cocktail Pick/ Cocktail Umbrella	683
Cocktail Shaker	674,677-678
Cocktail Strainer	674,678
Condiment Box/Container	683
Cotton Face Towel	694
Cotton Glass Cloth	694
Decanter	692
Drinking Straw	685
Floor Mat, Non-Grease	683
Frill Toothpick	684
Glass Bowl	688
Glass Rimmer	679
Hanging Glass Rack	685
Ice Bucket	699
Ice Crusher	711
Ice Cube Crusher	710
Ice Picker	698
Ice Scoop	698
Ice Tong	700
Interlocking Shelf Mat	683
Jigger	674,677
Juice Extracting Machine	711-712
Julep Mug	674
Julep Strainer	674,678
Lemon Clip	679
Lemon/Lime Squeezer	675,679
Milk Shake Mixer	708
Mixing Glass	674,678
Non-Slip Tray	694
Order Chit Booklet	687
Paper Napkin/Servette	683
Plastic Muddler	679
Plastic Ribbed Bar Pestle	675
Plastic Stirrer	683
Polycarbonate Stemware, Globets & Dessert Glass	703-707
Polypropylene basket	690
Punch Bowl	675
PVC Wire Basket	689
Rapid Pull Opener	675
Service & Bar Mat	683
Shooter Glass	693
Speed Pourer	671,680
Speed Rack, Stainless Steel	685
Squeeze Dispenser	686

Store & Pour	672,686	Insulated Beverage Servers	825
Tab Grabber	687	Induction Buffetware	714-715
Test Tube & Holder	693	Juice Bottles & Bowls	806, 807
Tumblers, Melamine	707	Oyster Tray	770
Tumblers, Polycarbonate	701	Petit Four Stand	809
Utility Bowl	677	Plate Cocktail Clip	838
Water Pitcher	691	Porcelain Mini Dish & Cocotte	801, 808
Whisky Pourer	680	Punch Bowl	767, 808
Wine Bottle Bracket	681	Roast Beef Wagon	844
Wine Bottle Holder	695	Salad Bowls	817
Wine Bottle Rotary Stand	681	Sauce Dispensing Pump	834 - 835, 836
Wine Bucket & Stand	675,697	Sauce Dispenser	838
Wine Cooler & Stand	695	Serving Trays	768 - 776
Wine Decanter	691	Serving Trolley, Wooden	844
Wine Dispenser	681	Serving Gears, Spoon, Ladle	820 - 824
Wine Measure	677	Serving Tray, Non-Slip	811
Wine Opener	676	Slate Buffet Series	791 - 793
Wine Vacuum Pump	682	Squeeze Bottles	843
		Straw Dispenser	833
		Tray Stand	811
		Wooden Serving Tray	771
		Wooden Buffet Series	775 - 781, 787
		Wooden Buffet Risers	794-797
		Wooden Bowl	798,799
		Wooden Cake Stand & Riser	802 - 805

10.

Food Service & Buffet Ware

Baby Chair	837
Booster Seat	837
Bar Counter, Portable	827
Bread Basket	809
Cast Iron Buffet Ware	716 - 719
Chafing Dish, Regal	720 - 727
Chafing Dish, Prince	728 - 735
Chafing Dish, Princess	736 - 746
Chafing Dish, Imperial Regency	747 - 749
Chafing Dish, Metro	750 - 752
Chafing Dish, General Series	758 - 761
ColdFest GN & Crocks	836
Condiment Holders	831 - 832
Condiment, Chilli & Soya	839 - 842
Condiment, Sugar Sachet	839
Cup Dispensers	833
Dispensers, Coffee & Milk	753, 756, 757
Dispensers, Juice & Cereal	753, 756, 757
Dispensers, General Ranges	764 - 766
Display Tray, Melamine	812 - 816
Display Tray & Bowls, Acrylic	818 - 819
Double Wall Bowl	810
Flambe Trolley	844
Food Bar	826
Fruit Tray & Stand	799
Napkin Dispensers	833
Heating Fuel	762 - 763
Insulated Beverage Dispenser	828 - 830

Cookware

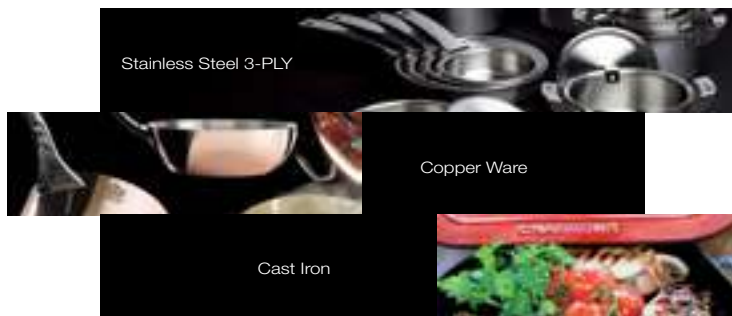

Kitchenware



Knives

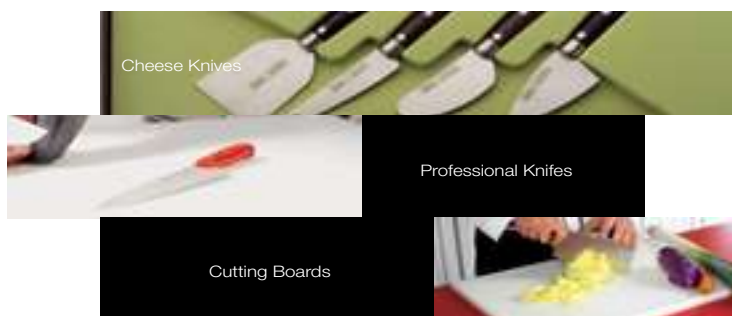

Pastry

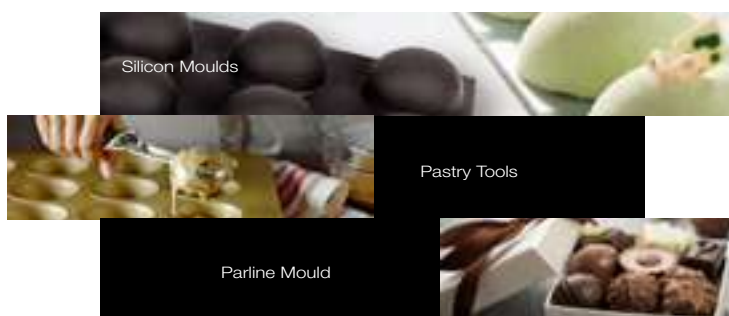

Chinese Kitchen

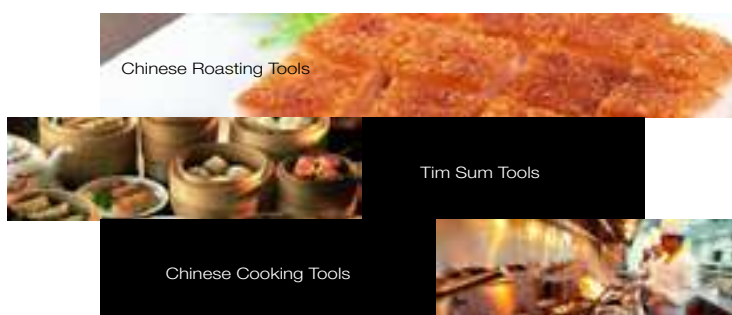

Japanese Ware



Equipment



Storage & Transport



Bar

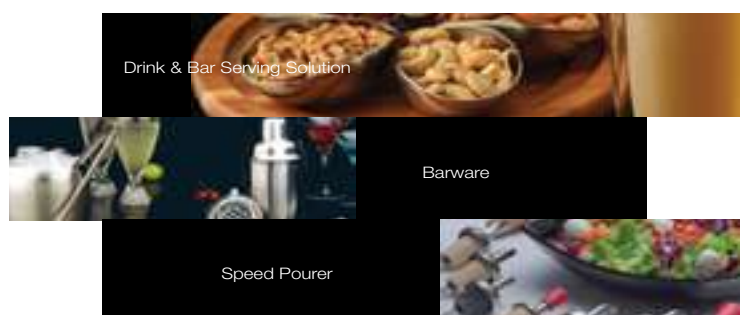

Food Service & Buffet Ware

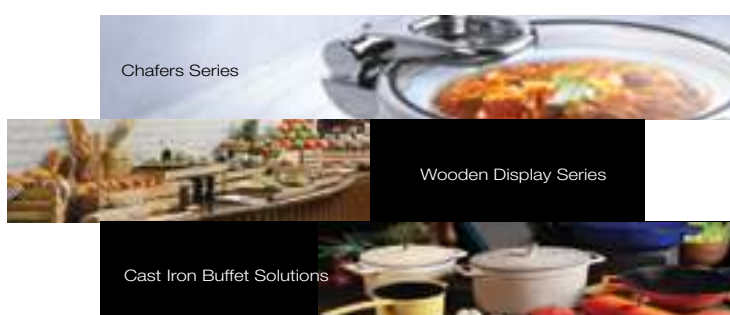



Cookware



PIAZZA 5 Stelle



- Thick • Tough • Wear-resistant • Fine Finish • Indestructible welding • Hollow ergonomic handles

The 5-Stelle collections are the fruit of advanced, constant research that puts Piazza in the avant-garde of The sector.

The handles, with a wide, solid grip, are patented, and in fact some aspects such as the curvature which facilitates their handy grip, the cavity which avoids burning the hands, the pads at the points where they are welded to the body which makes the handles hermetically sealed, resulted in the creation of a determining element for the definition of product quality.

The bodies are thicker than any in the category and the well-finished shine is a guarantee of long life. The heat diffuser with insert in aluminium and stainless steel base, can be used on all sources of heat, from traditional to induction.

Lastly, the collection come in a vast and complete assortment of sizes.



Stainless Steel Stock Pot

不锈钢厚底深汤桶

CODE	SIZE (Ø x h cm)	THICKNESS (mm)	CAP (lit)
1010120	20 x 20	1.5	6.3
1010124	24 x 24	1.8	10.9
1010128	28 x 28	1.8	17.3
1010132	32 x 32	1.8	25.8
1010136	36 x 36	2.0	36.7
1010140	40 x 40	2.5	50.3
1010145	45 x 45	2.5	71.7
1010150	50 x 50	2.5	98.3



Stainless Steel Sauce Pot

不锈钢厚底汤锅

CODE	SIZE (Ø x h cm)	THICKNESS (mm)	CAP (lit)
1010216	16 x 11	1.5	2.2
1010220	20 x 13	1.5	4.1
1010224	24 x 15	1.8	6.8
1010228	28 x 18	1.8	11.1
1010232	32 x 20	1.8	16.1
1010236	36 x 22	2.0	22.5
1010240	40 x 25	2.5	31.5
1010245	45 x 28	2.5	44.7
1010250	50 x 32	2.5	63.0



Stainless Steel Medium Casserole Pot

不锈钢厚底中汤锅

CODE	SIZE (Ø x h cm)	THICKNESS (mm)	CAP (lit)
1010316	16 x 8	1.5	1.6
1010320	20 x 9	1.5	2.8
1010324	24 x 10	1.8	4.5
1010328	28 x 12	1.8	7.4
1010332	32 x 15	1.8	12.1
1010336	36 x 17	2.0	17.4
1010340	40 x 19	2.5	24.0
1010345	45 x 22	2.5	35.1
1010350	50 x 25	2.5	49.3

Stainless Steel Shallow Casserole Pot

不锈钢厚底浅汤锅

CODE	SIZE (Ø x h cm)	THICKNESS (mm)	CAP (lit)
1010424	24 x 8	1.8	3.6
1010428	28 x 9	1.8	5.6
1010432	32 x 10	1.8	8.1
1010436	36 x 11	2.0	11.3
1010440	40 x 13	2.5	16.4
1010445	45 x 14	2.5	22.4
1010450	50 x 16	2.5	31.6



Stainless Steel High Sauce Pan

不锈钢厚底单柄汤锅

CODE	SIZE (Ø x h cm)	THICKNESS (mm)	CAP (lit)
1010516	16 x 11	1.5	2.2
1010520	20 x 13	1.5	4.1
1010524	24 x 15	1.8	6.8
1010528	28 x 18	1.8	11.1



Stainless Steel Medium Sauce Pan

不锈钢厚底单柄汁锅

CODE	SIZE (Ø x h cm)	THICKNESS (mm)	CAP (lit)
1010616	16 x 8	1.5	1.6
1010620	20 x 9	1.5	2.8
1010624	24 x 10	1.8	4.5
1010628	28 x 12	1.8	7.4



Stainless Steel Shallow Sauce Pan

不锈钢厚底单柄浅汁锅

CODE	SIZE (Ø x h cm)	THICKNESS (mm)	CAP (lit)
1010724	24 x 8	1.8	3.6
1010728	28 x 9	1.8	5.6
1010732	32 x 10	1.8	8.1



Stainless Steel Cover

不锈钢锅盖

CODE	SIZE (Ø x h cm)	THICKNESS (mm)
1010916	16	0.8
1010920	20	0.8
1010924	24	0.8
1010928	28	0.8
1010932	32	1.0
1010936	36	1.0
1010940	40	1.0
1010945	45	1.0
1010950	50	1.0



PIAZZA

COLLEZIONE *ilCuoco*
Chef COLLECTION

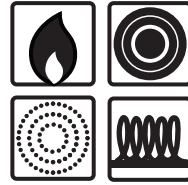

- Made In Stainless Steel Aisi 304
- Thicker Walls And Handles Designed To Reach The Highest Degree In Strength, Long Life And Thermal Conductivity
- Welded Handles At Highest Roughness
- Thicker Heat Diffuser Base, Excellent Resistance To Thermal Shock
- Ideal Source For Induction Of The Latest Generation
- Whole Range Of Types And Dimensions



Stainless Steel Stock Pot 不锈钢厚底深汤桶

CODE	SIZE (Ø x h cm)	CAP (lit)
1011920	20 x 20	6.3
1011924	24 x 24	10.9
1011928	28 x 28	17.3
1011932	32 x 32	25.8
1011936	36 x 36	36.7
1011940	40 x 40	50.3
1011945	45 x 45	71.7
1011950	50 x 50	98.3



Stainless Steel Sauce Pot 不锈钢厚底汤锅

CODE	SIZE (Ø x h cm)	CAP (lit)
1012016	16 x 11	2.2
1012020	20 x 13	4.1
1012024	24 x 15	6.8
1012028	28 x 18	11.1
1012032	32 x 20	16.1
1012036	36 x 22	22.5
1012040	40 x 25	31.5
1012045	45 x 28	44.7
1012050	50 x 32	63.0



Stainless Steel Medium Casserole Pot 不锈钢汤厚底中锅

CODE	SIZE (Ø x h cm)	CAP (lit)
1012116	16 x 8	1.6
1012120	20 x 9	2.8
1012124	24 x 10	4.5
1012128	28 x 12	7.4
1012132	32 x 15	12.1
1012136	36 x 17	17.4
1012140	40 x 19	24.0
1012145	45 x 22	35.1
1012150	50 x 25	49.3



Stainless Steel Low Casserole Pot 不锈钢汤厚底浅锅

CODE	SIZE (Ø x h cm)	CAP (lit)
1012224	24 x 8	3.6
1012228	28 x 9	5.6
1012232	32 x 10	8.1
1012236	36 x 11	11.3
1012240	40 x 13	16.4
1012245	45 x 14	22.4
1012250	50 x 16	31.6

Stainless Steel High Sauce Pan
 不锈钢厚底单柄高汁锅

CODE	SIZE (Ø x h cm)	CAP (lit)
1012316	16 x 11	2.2
1012320	20 x 13	4.1
1012324	24 x 15	6.8
1012328	28 x 18	11.1



Stainless Steel Medium Sauce Pan
 不锈钢单厚底单柄中汁锅

CODE	SIZE (Ø x h cm)	CAP (lit)
1012416	16 x 8	1.6
1012420	20 x 9	2.8
1012424	24 x 10	4.5
1012428	28 x 12	7.4



Stainless Steel Shallow Sauce Pan
 不锈钢单柄浅汁锅

CODE	SIZE (Ø x h cm)	CAP (lit)
1012524	24 x 8	3.6
1012528	28 x 9	5.6



Stainless Steel Frying Pan
 不锈钢厚底平底煎锅

CODE	SIZE (Ø x h cm)
1012620	20 x 4.5
1012624	24 x 5.0
1012628	28 x 5.5
1012632	32 x 6.0
1012636	36 x 6.5
1012640	40 x 7.0



Stainless Steel Curved Saute Pan
 不锈钢厚底单柄汁锅

CODE	SIZE (Ø x h cm)	CAP (lit)
1012716	16 x 6.0	1.00
1012718	18 x 6.0	1.20
1012720	20 x 6.5	1.50
1012722	22 x 7.0	1.95
1012724	24 x 7.5	2.50



Stainless Steel Cover
 不锈钢锅盖

CODE	SIZE (Ø cm)	THICKNESS (mm)
1010916	16	0.8
1010920	20	0.8
1010924	24	0.8
1010928	28	0.8
1010932	32	1.0
1010936	36	1.0
1010940	40	1.0
1010945	45	1.0
1010950	50	1.0



PIAZZA

3-PLY

A COMPLETE RANGE OF SMALL CASSEROLES,
PRACTICAL AND LIGHT,
FOR ANY COOKING AND SERVICE NEED

- THICK 1,2MM, POURING EDGE
- SUITABLE FOR GAS, INDUCTION, HOTPLATES AND CERAMIC, ALWAYS MAINTAINING HIGH CONDUCTIVITY
- ERGONOMIC HANDLES IN STAINLESS STEEL DESIGNED TO GIVE A SAFE AND COMFORTABLE GRIP
- THE SHAPE OF WELDING OF THE HANDLES ENSURES THE BEST SEALING WHILE THE UPPER OPENING ALLOWS COOLING. THE OPEN OUTLINE GUARANTEES THE EXCELENT HYGIENE
- THE LIDS'S KNOB HAND CAN BE HANGED TO THE CASSEROLES

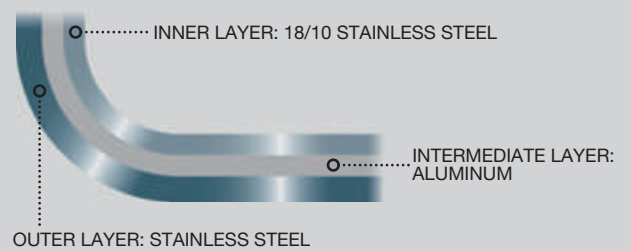

Stainless Steel Deep Cook Pot
 不锈钢双柄深汁锅

CODE	SIZE (Ø x h cm)	CAP (lit)
1013008	8.0 x 5.0	0.2
1013010	10.0 x 6.5	0.4
1013012	12.0 x 8.0	0.75
1013014	14.0 x 9.0	1.2
1013016	16.0 x 11.0	2.0



Stainless Steel Medium Cook Pot
 不锈钢双柄汁锅

CODE	SIZE (Ø x h cm)	CAP (lit)
1013110	10 x 4.5	0.25
1013112	12 x 6.0	0.5
1013114	14 x 7.0	0.9
1013116	16 x 8.0	1.4



Stainless Steel Deep Sauce Pan
 不锈钢单柄深汁锅

CODE	SIZE (Ø x h cm)	CAP (lit)
1013208	8.0 x 5.0	0.2
1013210	10.0 x 6.5	0.4
1013212	12.0 x 8.0	0.75
1013214	14.0 x 9.0	1.2
1013216	16.0 x 11.0	2.0



Stainless Steel Medium Sauce Pan
 不锈钢单柄汁锅

CODE	SIZE (Ø x h cm)	CAP (lit)
1013310	10 x 4.5	0.25
1013312	12 x 6.0	0.5
1013314	14 x 7.0	0.9
1013316	16 x 8.0	1.4



Stainless Steel Frying Pan
 不锈钢单柄煎锅

CODE	SIZE (Ø x h cm)
1013410	10 x 3
1013412	12 x 3
1013414	14 x 3
1013416	16 x 3



Stainless Steel Frying Pan with 2-Handle
 不锈钢双柄煎锅

CODE	SIZE (Ø x h cm)
1013510	10 x 3
1013512	12 x 3
1013514	14 x 3
1013516	16 x 3



Stainless Steel Cover
 不锈钢锅盖

CODE	SIZE (Ø cm)
1013608	8
1013610	10
1013612	12
1013614	14
1013616	16



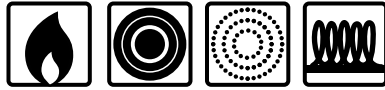

- Stainless Steel Disk (Induction Ready) • Aluminium Disk • Stainless Steel Body

For Pots and Pans optimum heat transfer is achieved using a triple bottom in stainless steel, aluminium and stainless steel. This heavy duty bottom has a "sandwich" construction with the aluminium enclosed by stainless steel.

With this professional bottom. OZTI pots and pans are perfect for use on any kind of stove whether induction, electrical, glass, ceramic or gas.

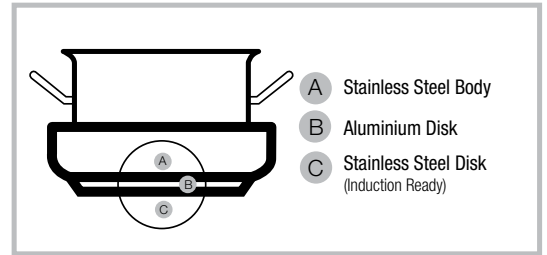

Stainless Steel Stock Pot 不锈钢厚底深汤桶

CODE	SIZE (Ø x h cm)	CAP (lit)
1020120	20 x 19	5.75
1020122	24 x 20	8.5
1020124	24 x 24	10.5
1020128	28 x 28	17.0
1020132	32 x 32	25.0
1020136	36 x 36	36.0
1020140	40 x 40	47.5
1020145	45 x 45	79.0
1020150	50 x 50	95.0
1020155	60 x 55	150 * Non-Induction



Stainless Steel Sauce Pot 不锈钢厚底中汤锅

CODE	SIZE (Ø x h cm)	CAP (lit)
1020220	20 x 13.0	3.75
1020222	22 x 14.5	5.25
1020224	24 x 15.0	6.0
1020228	28 x 17.0	10.0
1020232	32 x 19.0	14.5
1020236	36 x 22.0	20.5
1020240	40 x 25.0	29.5
1020245	45 x 28.0	42.5
1020250	50 x 30.0	54.5
1020260	60 x 35.0	94.0



Stainless Steel Casserole Pot 不锈钢厚底浅汤锅

CODE	SIZE (Ø x h cm)	CAP (lit)
1020320	20 x 9.0	2.5
1020322	22 x 9.5	3.5
1020324	24 x 10.5	4.25
1020328	28 x 12.0	7.0
1020332	32 x 15.0	11.0
1020336	36 x 17.0	16.0
1020340	40 x 19.0	22.0
1020345	45 x 22.0	32.5
1020350	50 x 20.0	35.0



Stainless Steel Saute Pot 不锈钢厚底汁锅

CODE	SIZE (Ø x h cm)	CAP (lit)
1020432	32 x 8	5.5
1020436	36 x 8	6.75
1020440	40 x 8	9.0
1020445	45 x 10	13.0
1020450	50 x 10	17.0

Stainless Steel High Saucepan

不锈钢厚底单柄高身汁锅

CODE	SIZE (Ø x h cm)	CAP (lit)
1020516	16 x 11	2.0
1020518	18 x 12	2.75
1020520	20 x 13	3.75
1020524	24 x 15	6.0
1020528	28 x 17	10

**Stainless Steel Saucepan**

不锈钢厚底单柄矮身汁锅

CODE	SIZE (Ø x h cm)	CAP (lit)
1020612	12 x 6.0	0.5
1020614	14 x 7.0	1.0
1020616	16 x 7.5	1.5
1020618	18 x 8.0	1.75
1020620	20 x 9.0	2.5
1020624	24 x 10.5	4.25
1020628	28 x 12.0	7.0

**Stainless Steel Curved Saute Pan**

不锈钢厚底汁锅

CODE	SIZE (Ø x h cm)	CAP (lit)
1020716	16 x 6	0.75
1020718	18 x 6	1.0
1020720	20 x 6	1.25
1020722	22 x 7	2.0
1020724	24 x 7	2.25

**Stainless Steel Dome Cover**

不锈钢锅盖

CODE	SIZE (Ø cm)
1021116	16
1021118	18
1021120	20
1021122	22
1021124	24
1021128	28
1021132	32
1021136	36
1021140	40
1021145	45
1021150	50
1021160	60

**Stainless Steel 2 Handle Frying Pan**

(Sandwich Base)

不锈钢厚底平底煎锅

CODE	SIZE (Ø x h cm)
1021020	20 x 4.0
1021024	24 x 4.5
1021026	26 x 5.0
1021028	28 x 5.0
1021032	32 x 5.5
1021036	36 x 6.0
1021040	40 x 6.0





Stainless Steel Frying Pan
不锈钢厚底平底煎锅

CODE	SIZE (Ø x h cm)
1020820	20 x 4.0
1020824	24 x 4.5
1020826	26 x 5.0
1020828	28 x 5.0
1020832	32 x 5.5
1020836	36 x 6.0 / with front handle
1020840	40 x 6.0 / with front handle



Stainless Steel Non-Stick Frying Pan
不锈钢厚底平底煎锅

CODE	SIZE (Ø x h cm)
1020920	20 x 4.0
1020924	24 x 4.5
1020926	26 x 5.0
1020928	28 x 5.0
1020932	32 x 5.5
1020936	36 x 6.0 / with front handle
1020940	40 x 6.0 / with front handle



Stainless Steel Couscous Cooker Set
不锈钢蒸丸子烹饪锅

CODE	SIZE (Ø cm)	CAP (lit)
1021328	Strainer:	28 x 12
	Sauce Pot:	28 x 17 10.0
1021336	Strainer:	36 x 17
	Sauce Pot:	36 x 22 20.5



Stainless Steel Asparagus Pot
不锈钢深底烫锅

CODE	SIZE (Ø x h cm)	CAP (lit)
1021416	16 x 29	6



Set of 4-Pcs Pasta Strainer
不锈钢意大利面捞网

CODE	SIZE (Ø x h cm)	Fits For
1021236	36 x 23	1020236
1021240	40 x 26	1020240



Stainless Steel Steamer Basket only
不锈钢意大利面捞网

CODE	SIZE (Ø x h cm)	Fits For (Ø x h cm)
1021220	20 x 9	20 x 13 & 20 x 17 Sauce Pot

GOURMET STEEL

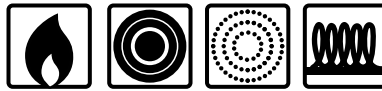

* The economy model for everyday use.
* Sandwich base suitable for any kind of stove, induction, electrical, glass, ceramic or gas.

Stainless Steel Stock Pot 不锈钢厚底有盖汤桶

CODE	SIZE (Ø x h cm)	CAP (lit)	THICKNESS (mm)
1030120	20 x 20	6.30	0.8
1030125	25 x 25	12.30	0.8
1030128	28 x 28	17.20	0.8
1030130	30 x 30	21.20	0.8
1030132	32 x 32	25.70	0.8
1030136	36 x 36	36.60	1.0
1030140	40 x 40	50.30	1.0
1030145	45 x 45	71.60	1.2
1030150	50 x 50	98.20	1.2
1030155	55 x 55	130.7	1.2
1030160	60 x 60	169.6	1.2



Stainless Steel Sauce Pot 不锈钢厚底有盖汤锅

CODE	SIZE (Ø x h cm)	CAP (lit)	THICKNESS (mm)
1030230	30 x 20	14.1	0.8
1030232	32 x 22	17.7	0.8
1030236	36 x 24	24.4	1.0
1030240	40 x 26	32.7	1.0
1030245	45 x 28	44.5	1.2
1030250	50 x 30	58.9	1.2
1030255	55 x 35	83.2	1.2
1030260	60 x 40	113.1	1.2



Stainless Steel Casserole Pot 不锈钢厚底有盖钢锅

CODE	SIZE (Ø x h cm)	CAP (lit)	THICKNESS (mm)
1030332	32 x 12	10	0.8
1030336	36 x 14	14	1.0
1030340	40 x 15	18	1.0
1030345	45 x 17	27	1.2
1030350	50 x 18	35	1.2



Stainless Steel High Saucepan 不锈钢厚底单柄汁锅 (高身)

CODE	SIZE (Ø x h cm)	CAP (lit)	THICKNESS (mm)
1030416	16 x 10.0	2.0	0.8
1030418	18 x 11.5	2.8	0.8
1030420	20 x 12.5	3.9	0.8
1030422	22 x 13.5	5.1	0.8
1030424	24 x 14.0	6.3	0.8
1030426	26 x 15.0	8.0	0.8 / with front handle
1030428	28 x 16.0	9.9	0.8 / with front handle
1030430	30 x 18.0	12.7	0.8 / with front handle



Stainless Steel Shallow Saucepan
 不锈钢厚底单柄汁锅 (矮身)



CODE	SIZE (Ø x h cm)	CAP (lit)	THICKNESS (mm)
1030516	16 x 6.0	1.2	0.8
1030518	18 x 6.5	1.7	0.8
1030522	22 x 7.5	2.9	0.8
1030524	24 x 8.0	3.6	0.8
1030526	26 x 8.5	4.5	0.8 / with front handle
1030528	28 x 9.5	5.8	0.8 / with front handle
1030530	30 x 10.0	7.1	0.8 / with front handle

Stainless Steel Frying Pan
 不锈钢厚底平底煎锅



CODE	SIZE (Ø x h)	THICKNESS (mm)
1030620	20 x 4.0	0.8
1030622	22 x 4.1	0.8
1030624	24 x 4.5	0.8
1030626	26 x 4.7	0.8
1030628	28 x 4.8	0.8
1030640	40 x 5.5	0.8

Stainless Steel 2 Handle Frying Pan
 不锈钢双柄厚底平底煎锅



CODE	SIZE (Ø x h)	THICKNESS (mm)
1030736	36 x 5.3	0.8
1030740	40 x 5.5	0.8



Aluminium Stock Pot

厚身有盖铝制深汤锅

CODE	SIZE (Ø x h cm)	CAP (lit)	CODE	SIZE (Ø x h cm)	CAP (lit)
1040116	28.0 x 25.0	16	1040155	40.5 x 41.0	55
1040120	30.0 x 28.0	20	1040160	44.0 x 41.0	60
1040124	32.0 x 29.0	24	1040166	44.0 x 42.0	66
1040126	32.0 x 31.0	26	1040180	48.0 x 43.0	80
1040132	35.0 x 32.0	32	1040111	51.0 x 45.0	100
1040136	35.0 x 35.0	36	1040121	56.5 x 49.5	120
1040140	37.0 x 36.0	40	1040141	58.0 x 51.5	140
1040150	40.5 x 38.0	50	1040161	58.0 x 58.0	160



Aluminium Sauce Pots

厚身有盖铝制中汤锅

CODE	SIZE (Ø x h cm)	CAP (lit)
1040214	30.0 x 20.0	14
1040220	32.0 x 23.5	20
1040226	35.0 x 25.3	26
1040234	40.5 x 25.5	34
1040240	45.7 x 25.5	40
1040260	51.0 x 28.3	60



Aluminium Brazier Pots

厚身有盖铝制中汤锅

CODE	SIZE (Ø x h cm)	CAP (lit)
1040315	35.0 x 15.0	15
1040318	40.5 x 15.0	18
1040324	44.0 x 16.0	24
1040328	51.0 x 14.0	28
1040335	55.0 x 14.5	35
1040340	58.0 x 15.2	40



Heavy Duty Aluminium Double Boil Pot with Cover

(2-Layer)

厚身铝制双层炖锅

CODE	SIZE (Ø x h cm)	CAP (qt)
1040416	31 x 32	16
1040420	33 x 34	20



Aluminium Pasta Cooking Pot 4-inserts without Cover

无盖铝煮意大利面桶 / 4捞面格

CODE	SIZE (Ø x h cm)
1040500	36 x 18



Perforated Aluminium Basket

铝制汤篮

CODE	SIZE (Ø x h cm)	CAP (qt)
1040736	32 x 28	36
1040755	36.5 x 34.2	55
1040760	38.5 x 34.5	60
1040780	46 x 34.5	80



VOLLRATH® Aluminium Frying Pans

Setting
the Standard™



Extra hard impact resistant 3004 aluminium for heavy usage application



TriVent™ Handle

- Ergonomic
- Durable
- Cooler to Touch
- Oven safe to 450°F (232°C)

EverTite™ Riveting System offers lifetime warranty against loose riverts



Aluminium Frying Pan (Silicon Handle) 铝制厚身平底煎锅

CODE	SIZE	
	(Ø inch)	(Ø x h cm)
1060118	7	18 x 4.4
1060120	8	20 x 4.8
1060125	10	25 x 5.4
1060130	12	30 x 6.4
1060136	14	36 x 7.0



Aluminium Non-Stick Frying Pan (Silicon Handle) 铝制厚深不粘平底煎锅

CODE	SIZE	
	(Ø inch)	(Ø x h cm)
1060218	7	18 x 4.4
1060220	8	20 x 4.8
1060225	10	25 x 5.4
1060230	12	30 x 6.4
1060236	14	36 x 7.0

Tribute® 3-Ply Stainless Steel Cookware



Setting the Standard™

New Trivent® Handle has a unique ergonomic design that reduces stress and fatigue. The vented handle design reduces heat transfer from pan to handle, maximizing operator comfort.

Trivent™ Silicone Handles are rated at 450°F (232°C) for stovetop or oven use.

18-8 stainless interior does not affect colors and flavor of food.

18-0 stainless exterior induction ready.

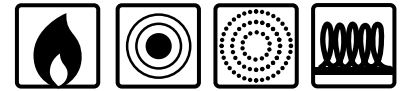

EverTite™ Riveting System offers a lifetime warranty against loose rivets.

3-Ply construction maintains shape under constant commercial use.

3004 aluminum core provides even heat on bottom of pan and side walls.

Induction Frying Pan 三层不锈钢煎锅

CODE	SIZE	
	(Ø inch)	(Ø x h cm)
1060318	7	18 x 4.4
1060320	8	20 x 4.8
1060325	10	25 x 5.4
1060330	12	30 x 6.4
1060336	14	36 x 7.0



Non-Stick Induction Frying Pan 三层不锈钢不粘煎锅

CODE	SIZE	
	(Ø inch)	(Ø x h cm)
1060418	7	18 x 4.4
1060420	8	20 x 4.8
1060425	10	25 x 5.4
1060430	12	30 x 6.4
1060436	14	36 x 7.0



Induction Frying Wok 三层不锈钢炒锅

CODE	SIZE	
	(Ø inch)	(Ø cm)
1060628	11	28 x 8.9
1060636	14	36 x 11.1





Stainless Steel Wok for Induction Cooker 不锈钢炒锅 (用于电磁炉)



CODE	SIZE (Ø x h cm)
1070130	30 x 4.0



Stainless Steel Wok for Induction Cooker 不锈钢炒锅 (用于电磁炉)

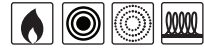

CODE	SIZE (Ø cm)	THICKNESS (mm)
1080136	36 x 9.5	1.5



Iron Wok for Induction Cooker 铁炒锅 (用于电磁炉)



CODE	SIZE (Ø cm)	THICKNESS (mm)
1080235	35.5 x 9.0	1.5



Blue Steel Frying Pan 蓝铁煎锅



CODE	SIZE (Ø x h)	THICKNESS (mm)	CODE	SIZE (Ø x h)	THICKNESS (mm)
1080314	14 x 3.3	1.0	1080328	28 x 5.1	1.2
1080316	16 x 3.7	1.0	1080330	30 x 5.5	1.2
1080318	18 x 4.0	1.0	1080332	32 x 5.8	1.2
1080320	20 x 4.2	1.0	1080336	36 x 6.2	1.5
1080322	22 x 4.0	1.0	1080340	40 x 6.5	1.5
1080324	24 x 4.8	1.0	1080345	45 x 7.5	1.5
1080326	26 x 5.0	1.0			

Blue Steel • Perfect for Searing, Frying, Browning
• 1-1.5mm thick for less powerful heat sources • Semi-pro and domestic use • Quick heating time • Extra strong handle



2 Handle Blue Steel Frying Pan 双柄蓝铁煎锅



CODE	SIZE (Ø x h)	THICKNESS (mm)
1080420	20 x 4.2	1.0
1080424	24 x 4.8	1.0
1080428	28 x 5.1	1.2
1080432	32 x 5.8	1.2
1080436	36 x 6.2	1.5
1080440	40 x 7.0	1.5
1080445	45 x 7.6	1.5
1080450	50 x 8.0	1.5



Blue Steel Deep Fryer Pan 双柄深煎锅



CODE	SIZE (Ø x h)	CAPACITY (lit)
1220136	36 x 11.0	8.8
1220140	40 x 13.4	12.2



Tinned Frying Basket 炸网



CODE	SIZE (Ø x h cm)
1220235	35 x 11.5
1220240	40 x 12.4

2 Handles Paella Pan 双柄西班牙海鲜饭盘

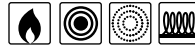

CODE	SIZE (Ø x h cm)	THICKNESS (mm)	SIZE INDICATION
1230124	24 x 3.5	1.0	1 Portion
1230128	28 x 4.0	1.0	3 Portions
1230132	32 x 4.2	1.0	5 Portions
1230136	36 x 4.5	1.0	7 Portions
1230146	46 x 5.0	1.0	12 Portions
1230150	50 x 5.2	1.0	14 Portions
1230160	60 x 5.0	1.0	19 Portions
1230180	80 x 6.5	1.5	40 Portions
1230100	100 x 6.5	1.5	85 Portions



Round Steel Frying Pan 圆铁煎锅



CODE	SIZE (Ø x h cm)	THICKNESS (mm)
1080518	18 x 2.9	2.5
1080520	20 x 3.3	2.5
1080522	22 x 3.4	2.5
1080524	24 x 3.8	2.5
1080526	26 x 4.0	3.0
1080528	28 x 4.0	3.0
1080530	30 x 4.2	3.0
1080532	32 x 4.2	3.0 **
1080536	36 x 5.1	3.0 **
1080540	40 x 5.3	3.0 **
1080545	45 x 5.3	3.0 **
1080550	50 x 5.7	3.0 **

** With 2 Handle

Carbone Plus

- Perfect for Searing, Frying, Browning
- 2.5-3mm thick for professional strong heat sources
- Perfect heat conduction
- Extra strong handle
- Induction



ACIER
CARBONE
STEEL

Round Steel Pancake Pan 圆铁煎饼锅



CODE	SIZE (Ø x h cm)	THICKNESS (mm)
1080618	18 x 1.30	2.5
1080620	20 x 1.30	2.5
1080622	22 x 1.45	2.5
1080624	24 x 1.45	2.5
1080626	26 x 1.50	2.5
1080630	30 x 2.80	2.5



ACIER
CARBONE
STEEL

Oval Steel Fish Frying Pan 椭圆形铁煎锅



CODE	SIZE (l x w x h cm)	THICKNESS (mm)
1080732	32 x 23.5 x 4.6	2.5
1080736	36 x 26.5 x 4.8	2.5



ACIER
CARBONE
STEEL

Rectangular Steel Grill Pan 铁格栅煎锅



CODE	SIZE (l x w x h cm)	THICKNESS (mm)
1080838	38 x 26 x 2	2.5



ACIER
CARBONE
STEEL



Steel Blinis Pan 不粘铁煎锅



CODE	SIZE (Ø x h cm)	THICKNESS (mm)
1081612	12 x 2	2.5



Induction Non-Stick Frying Pan 有柄不粘煎锅



CODE	SIZE (Ø x h cm)	THICKNESS (mm)
1080920	20 x 3.0	5
1080924	24 x 3.7	5
1080928	28 x 3.8	5
1080932	32 x 4.5	5
1080936	36 x 4.7	5

The professional non-stick aluminium frypan CHOC RESTO INDUCTION is covered with a high-quality improved PTFE coating. Therefore, it is resistant to abrasion and to heat. The strip handle is firmly riveted and covered with a heat-resistant epoxy. All hotplates.



Aluminium Non-Stick Frying Pan 圆形不粘平底煎锅



CODE	SIZE (Ø x h cm)	THICKNESS (mm)
1081120	20 x 3.0	4.0
1081124	24 x 3.5	4.0
1081126	26 x 3.7	4.0
1081128	28 x 3.8	4.0
1081130	30 x 4.5	4.0
1081132	32 x 4.5	4.0
1081136	36 x 4.7	5.0
1081140	40 x 5.3	5.0

Choc

- Made of thick Aluminium
- Optimum non-stick and non-slip quality



Aluminium Non-Stick Crepe Pan 不粘平底煎锅



CODE	SIZE (Ø x h cm)	THICKNESS (mm)
1081222	22 x 1.5	3.0
1081226	26 x 1.5	3.3
1081230	30 x 1.5	3.3



Aluminium Non-Stick Fish Pan 不粘煎锅



CODE	SIZE (Ø x h cm)	THICKNESS (mm)	
1081336	36 x 26 x 4.3	5	Oval
1081338	38 x 26 x 4.2	5	Rectangular

Aluminium Non-Stick Paella Pan 西班牙平底锅



CODE	SIZE (Ø x h cm)	THICKNESS (mm)
1081436	36 x 4.7	5.0
1081440	40 x 5.2	5.0



Choc

Aluminium Non-Stick Blinis Pan 不粘铁煎锅



CODE	SIZE (Ø x h cm)	THICKNESS (mm)
1081512	12 x 1.0	3.3
1081514	14 x 2.0	4.0



Choc

Aluminium Non-Stick Saute Pan 不粘铝煎盘



CODE	SIZE (Ø x h cm)	THICKNESS (mm)
1081720	20 x 6.5	4.0
1081724	24 x 7.0	4.0
1081728	28 x 7.0	4.0



Choc

Aluminium Non-Stick Frying Pan 平底不粘煎锅



CODE	SIZE (Ø x h cm)	THICKNESS (mm)
1081820	20 x 3.5	3.0
1081824	24 x 3.5	3.3
1081828	28 x 4.0	3.3
1081832	32 x 4.4	3.3
1081836	36 x 4.5	4.0
1081840	40 x 5.4	4.0

Choc Access

- Aluminium non-stick frypan
- Semi-professional
- High quality PFE non-stick coating



Choc
ACCESS

Non-Stick Frying Pan, Coloured Handle 不粘平底煎锅



CODE	SIZE (Ø x h cm)	THICKNESS (mm)
1081920-XX	20 x 3.0	4.0
1081924-XX	24 x 3.5	4.0
1081928-XX	28 x 4.0	4.0
1081932-XX	32 x 4.5	4.0

***Available Color**

■ BL ■ RD ■ GR ■ YE

When ordering blue handles add **CODE** suffix to item number (example: 1081920-BL)



Choc
HACCP

Choc HACCP

- Keeps each food taste separate and from cross contamination with colour coded handle
- Riveted with extra strong handle and with coloured epoxy coating



Non-Stick Frying Pan (Economy) 不粘平底煎锅 (经济型)



CODE	SIZE (Ø cm)
1100116	16
1100118	18
1100120	20
1100124	24
1100126	26
1100128	28
1100130	30
1100132	32



Non-Stick Frying Pan (Medium Deep) 不粘平底煎锅

CODE	SIZE (Ø cm)
1100220	20
1100224	24
1100226	26
1100228	28



Non-Stick Frying Pan (Deep) 不粘平底煎锅 (深)

CODE	SIZE (Ø cm)
1100326	26
1100328	28
1100330	30
1100332	32



Non-Stick Nylon Turner 不粘平底煎铲



CODE	SIZE (Ø x h cm)
1082028	28 x 6.5



Exoglass Frying Tong 耐高温铲



CODE	SIZE (l cm)	FIT
2430129	29	For Non-Stick Pan

Exoglass Slotted Turner 耐高温铲



CODE	SIZE (l x w cm)	FIT
2102415	15 x 9	For Non-Stick Pan



Exoglass Angled Turner 耐高温铲



CODE	SIZE (l x w cm)	FIT
2102512-03	12.5 x 8.5	For Non-Stick Pan



High Heat Silicon Spatula with Red Handle 耐高温刮刀



CODE	SIZE (l x w cm)	(inch)
2120110	26.2 x 5.5	9
2120113	34.6 x 7.0	14
2120116	42.2 x 7.0	16



High Temp Utility Tong with Nylon end & Coated Handle 耐高温尼龙头夹



CODE	SIZE (l x h cm)	(inch)
2250424	24.0	9
2250430	30.5	12
2250440	40.6	16



Stainless Steel Fish Kettle with Grid + Cover (Induction) 不锈钢蒸鱼锅



CODE	SIZE (Ø x h cm)	THICKNESS (mm)
1082150	50 x 16.5 x 11.5	0.8
1082162	60 x 16.5 x 9.5	0.8





de BUYER®

DEPUIS 1830



PRIMA MATERA

INOUCUIVRE INDUCTION 90%Cu

way of the future

Copper for exceptional cooking
Stainless Steel for easy cleaning
90% Copper - 10% Stainless Steel - 2-mm thick

Special ferro-magnetic bottom
for all hotplates including INDUCTION

Cast stainless steel riveted ergonomic handles
« à la Française »



Prima Matera range of copper and stainless steel on the inside enables to enjoy the exceptional degree of conductivity of copper on all types of heat sources, including INDUCTION, thanks to its magnetic bottom. The cast stainless steel ergonomic handle are firmly riveted.

“PRIMA MATERA” Induction Copper Stainless Steel Sauce Pan

单柄铜汁锅

CODE	SIZE (Ø x h cm)	THICKNESS (mm)	CAPACITY (lit)
6010114	14 x 7.3	2	1.2
6010116	16 x 8.3	2	1.8
6010118	18 x 9.3	2	2.5
6010120	20 x 10.5	2	3.3
6010124	24 x 12.4	2	6.0



“PRIMA MATERA” Induction Copper Stainless Steel Saute Pan

单柄铜汁锅

CODE	SIZE (Ø x h cm)	THICKNESS (mm)	CAPACITY (lit)
6011716	16 x 5.5	2	1.0
6011720	20 x 5.8	2	1.8
6011724	24 x 6.6	2	3.0
6011820	20 x 7.2	2	1.7 / Conical Shape
6011824	24 x 8.2	2	3.1 / Conical Shape



“PRIMA MATERA” Induction Copper Stainless Steel Frying Pan

单柄煎锅

CODE	SIZE (Ø x h cm)	THICKNESS (mm)
6010220	20 x 4	2
6010224	24 x 4	2
6010228	28 x 4	2
6010230	32 x 4	2



“PRIMA MATERA” Induction Copper Stainless Steel Stock Pot

双柄汤锅

CODE	SIZE (Ø x h cm)	THICKNESS (mm)	CAPACITY (lit)
6012420	20 x 18	2	5.7





“PRIMA MATERA” Induction Copper Stainless Steel High Stewpan
双柄高炖锅

CODE	SIZE (Ø x h cm)	THICKNESS (mm)	CAPACITY (lit)
6012516	24 x 16.5	2	1.8



“PRIMA MATERA” Induction Copper Stainless Steel Casserole Pot
双柄铜锅

CODE	SIZE (Ø x h cm)	THICKNESS (mm)	CAPACITY (lit)
6010316	16 x 8.8	2	1.8
6010320	20 x 10.3	2	3.3
6010324	24 x 12.3	2	5.4
6010328	28 x 13.5	2	8.0



“PRIMA MATERA” Induction Copper Stainless Steel Shallow Casserole Pot
双柄铜锅

CODE	SIZE (Ø x h cm)	THICKNESS (mm)	CAPACITY (lit)
6011920	20 x 5.8	2	1.8
6011924	24 x 6.8	2	3.1
6011928	28 x 9.2	2	4.9



Stainless Steel Lid
不锈钢盖

CODE	SIZE (Ø x h cm)	THICKNESS (mm)
1240114	14	1
1240116	16	1
1240118	18	1
1240120	20	1
1240124	24	1
1240128	28	1



Inocuvivre range of copper pots and pans is especially well adapted to the table and making flambés or can be used simply to decorate the kitchen interior. It can also be used for cooking on medium-power heat sources. The walls are stainless steel on the inside, which makes for easy upkeep and removes the need for re-tinning. Riveted bronze handle.

Inocuvivre "VIP" Copper Mini Saucepan with Lid 小单柄铜汁锅

CODE	SIZE (Ø x h cm)	THICKNESS (mm)	CAPACITY (lit)
6010409	9 x 4.8	1.0	0.3



Inocuvivre "VIP" Copper Mini Frying Pan 单柄圆形铜煎锅

CODE	SIZE (l x w x h cm)	THICKNESS (mm)
6012313	13 x 3.2	2



Inocuvivre "VIP" Copper Stainless Steel Sauce Pan 单柄铜汁锅

CODE	SIZE (Ø x h cm)	THICKNESS (mm)	CAPACITY (lit)
6010510	10 x 5.5	1.5	
6010512	12 x 6.0	1.5	0.8
6010514	14 x 7.0	1.5	1.0
6010516	16 x 8.5	1.5	1.6
6010518	18 x 9.0	1.5	2.5
6010520	20 x 10.0	1.5	3.5



Inocuvivre "VIP" Copper Saute Pan 单柄铜汁锅

CODE	SIZE (l x w x h cm)	THICKNESS (mm)	CAPACITY (lit)
6012216	16 x 5.0	1.2	1.0
6012220	20 x 6.0	1.2	1.8
6012224	24 x 6.5	1.2	3.0





Inocuivre "VIP" Copper Stainless Steel Saute Pot with Cover
铜炒锅

CODE	SIZE (Ø x h cm)	THICKNESS	CAPACITY
6010624	24 x 7.2	2.0	3.2
6010628	28 x 9.2	2.0	5.5



Inocuivre "VIP" Copper Stainless Steel Stew Pot with Cover
铜炖锅

CODE	SIZE (Ø x h cm)	THICKNESS (mm)	CAPACITY (lit)
6010710	10 x 5.5	1.2	Mini
6010716	16 x 8.0	1.2	1.6
6010720	20 x 10.0	1.5	3.5
6010724	24 x 11.5	2.0	5.2



Inocuivre "VIP" Copper Stainless Steel Round Frying Pan
单柄圆形铜锅

CODE	SIZE (Ø x h cm)	THICKNESS (mm)
6010820	20 x 3.0	2.0
6010824	24 x 4.0	2.0
6010828	28 x 4.0	2.0



Inocuivre "VIP" Copper Round Pan / Dish with 2 Handle
双柄圆形铜锅

CODE	SIZE (l x w x h cm)	THICKNESS (mm)
6012112	12 x 2.0	2.0
6012116	16 x 3.0	2.0
6012120	20 x 3.0	2.0
6012124	24 x 4.0	2.0



Inocuivre "VIP" Copper Stainless Steel Oval Pan with 2 Handle
双柄椭圆形铜锅

CODE	SIZE (l x w x h cm)	THICKNESS (mm)
6010932	32 x 23 x 4.5	1.5
6010936	36 x 26.2 x 4.5	1.5

Inocuvre "VIP" Copper Cover Only

铜锅盖

CODE	SIZE (Ø cm)	THICKNESS (mm)
6011112	12	1.2
6011114	14	1.2
6011116	16	1.2
6011118	18	1.2
6011120	20	1.2
6011124	24	1.2
6011128	28	1.2



Silver & Copper Cleaner

银或铜清洗剂

CODE	CAPACITY (lit)	FOR
6011612	1.0	Silver
6011613	1.0	Copper



Lucky Wood Silver Cleaner

银清洗剂

CODE	CAPACITY (lit)	FOR
6011614	1.0	Silver





de BUYER®
DEPUIS 1830

Affinity

THE SOLUTION FOR BUFFET

The Affinity® utensils range does away with the cumbersome chafing-dish, bringing a touch of sophistication and elegant appeal to your buffets and aperitif dinners, all at a reasonable price and with the practical benefits that this new collection offers.

ELEGANT

The Affinity and Mini-Affinity stainless steel casserole dishes, mini saucepans and mini sauté-pans are a sophisticated and tempting way to serve an extensive and varied selection of sweet or sour, hot or cold meals straight to table, giving your buffets an undeniable added value.

From oven to table, the mini Affinity® is the ideal choice for presenting your dishes in open and table-top kitchens.

PRACTICAL FOR EVERYONE

Buffets are easier to prepare; the utensils can be refilled with food as the meal progresses, and they keep the food hot.

The single servings delivered by the mini-Affinity range provide just the right portions for the number of guests, with little time needed to lay them out on the table. Guests can serve themselves in comfort, no longer having to grapple with a chafing-dish.

ALWAYS HOT

The material used in the Affinity range spreads the heat throughout the whole of the utensil rather than concentrating it at the bottom, to give you food that is heated evenly and for longer.

READY IN AN INSTANT

Perfect for «Live cooking stations» where the dish is prepared specially for and in front of the guest. The reactive material used in the Affinity range heats the food very quickly and evenly so your food is ready without delay. Its elegant style is perfect for preparing the food in front of the customer.

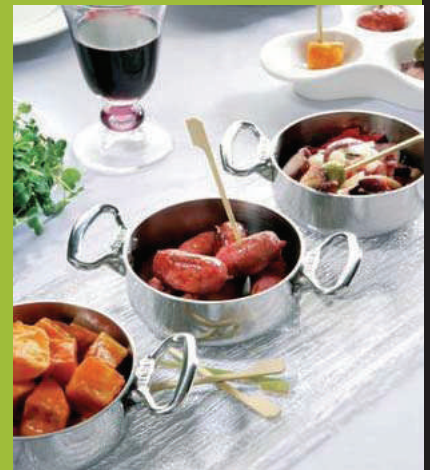

AUTHENTIC

Generous sizes, rounded edges, pouring lips:
Affinity is a true professional utensil dedicated to French Gastronomy.

ERGONOMIC

Curves and smart handles designed by de Buyer. Ergonomic handles
-made of cast stainless steel- for a natural grip without tiredness.

PROFESSIONAL QUALITY & ROBUST

Multilayer and multimaterial. Composite material made of stainless steel
and aluminium. For an ultra-fast and homogeneous cooking.

ALL HEAT SOURCES INCLUDING INDUCTION

Easy clearing. Dishwasher safe.

**"AFFINITY" Stainless Steel Sauce Pan**

不锈钢单柄汁锅

CODE	SIZE (Ø x h cm)	THICKNESS (mm)	CAPACITY (lit)
1240214	14 x 7.0	2.3	1.2
1240216	16 x 8.0	2.3	1.8
1240218	18 x 9.0	2.3	2.5
1240220	20 x 10.0	2.3	3.4

**"AFFINITY" Stainless Steel Saute Pan**

不锈钢单柄汁锅

CODE	SIZE (Ø x h cm)	THICKNESS (mm)	CAPACITY (lit)
1240320	20 x 6.5	2.3	1.8
1240324	24 x 7.5	2.8	3.0

**"AFFINITY" Rounded Stainless Steel Saute Pan**

不锈钢单柄汁锅

CODE	SIZE (Ø x h cm)	THICKNESS (mm)	CAPACITY (lit)
1240420	20 x 6.5	2.3	1.7
1240424	24 x 7.0	2.3	3.0

**"AFFINITY" Stainless Steel Frying Pan**

不锈钢单柄煎锅

CODE	SIZE (Ø x h cm)	THICKNESS (mm)
1240520	20 x 4.0	2.8
1240524	24 x 4.0	2.8
1240528	28 x 4.5	2.8
1240532	32 x 5.0	2.8

**"AFFINITY" Stainless Steel Non-Stick Frying Pan**

不锈钢不沾单柄煎锅

CODE	SIZE (Ø x h cm)	THICKNESS (mm)
1240620	20 x 3.0	2.8
1240624	24 x 3.5	2.8
1240628	28 x 4.0	2.8
1240632	32 x 4.5	2.8

**"AFFINITY" Stainless Steel Casserole Pot**

不锈钢锅

CODE	SIZE (Ø x h cm)	THICKNESS (mm)	CAPACITY (lit)
1240716	16 x 9	2.3	1.8
1240720	20 x 11	2.3	3.4
1240724	24 x 13	2.3	5.4
1240728	28 x 15	2.3	10.4





"AFFINITY" Stainless Steel Saute Pan
不锈钢双柄炒锅

CODE	SIZE (Ø x h cm)	THICKNESS (mm)
1240824	24 x 7.5	2.8



"AFFINITY" Stainless Steel Round Saute Pan
不锈钢双柄炒锅

CODE	SIZE (Ø x h cm)	THICKNESS (mm)	CAPACITY (lit)
1241328	28 x 15	2.7	3.0



"AFFINITY" Stainless Steel Wok with 2 Handles
不锈钢双柄炒锅

CODE	SIZE (Ø x h cm)	CAPACITY (lit)
1240932	32 x 12	4.0
1240933	32	Glass Lid For Wok



"AFFINITY" Stainless Steel Mini Stewpan w/Lid
迷你不锈钢锅

CODE	SIZE (Ø x h cm)	THICKNESS (mm)	CAPACITY (lit)
1241009	9 x 5.0	2.3	0.3
1241010	10 x 6.0	2.3	0.45
1241012	12 x 7.0	2.3	0.75
1241014	14 x 8.0	2.3	1.0



"AFFINITY" Stainless Steel Mini Saute Pan w/o Lid
迷你不锈钢双柄汁锅

CODE	SIZE (Ø x h cm)	THICKNESS (mm)
1241110	10 x 3.8	2.2



"AFFINITY" Stainless Steel Mini Frying Pan
迷你不锈钢单柄煎锅

CODE	SIZE (Ø x h cm)	THICKNESS (mm)
1241210	10 x 19	2.0



"AFFINITY" Stainless Steel Mini Sauce Pan
迷你不锈钢单柄汁锅

CODE	SIZE (Ø x h cm)	THICKNESS (mm)	CAPACITY (lit)
1241909	9 x 4.5	2.2	0.28



"AFFINITY" Stainless Steel Lid
不锈钢盖

CODE	SIZE (Ø cm)	THICKNESS (mm)
1240114	14	1.0
1240116	16	1.0
1240118	18	1.0
1240120	20	1.0
1240124	24	1.0
1240128	28	1.0

RISOLI



Primer incorporating hard mineral

Topcoat

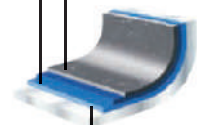

Reinforced intermediate



H.E.A.T. TECHNOLOGY

finox steel base applied by H.E.A.T method. Which offers and increased 50% efficiency on Induction performances.

PRODUCT TEST

> 350 Nh base traction
AQM certificate

Risoli showcases Italian chic in hand finished kitchenware made from thick high-pressed, die-cast aluminum with internal and external non-stick lining.



* Lid are sold Separately

Shallow Casserole Pot 铝制浅汤锅

CODE	SIZE (Ø x h cm)	THICKNESS (mm)	CAP (lit)
1242016	16 x 6.8	6	0.75
1242024	24 x 6.8	6	2.0
1242028	28 x 7.5	6	3.0
1242032	32 x 8.5	6	4.5
1242036	36 x 8.5	6	5.5



Sauce Pot 铝制浅平底汁锅

CODE	SIZE (Ø x h cm)	THICKNESS (mm)	CAPACITY (lit)
1242120	20 x 10.5	6	2.25
1242124	24 x 10.6	6	3.50



Flat Grill 铝制烧烤盘

CODE	SIZE (Ø x h cm)	THICKNESS (mm)	CAPACITY (lit)
1242240	40 x 25 x 5.50	7	
1242246	46 x 25 x 5.56	7	



Rectangular Roasting Pot 铝制烘烤锅

CODE	SIZE (l x w x h cm)	THICKNESS (mm)
1242338	38 x 22 x 10.5	6



* Lid are sold Separately

Sauce Pan 铝制平底汁锅

CODE	SIZE (Ø x h cm)	THICKNESS (mm)	CAPACITY (lit)
1242416	16 x 10.2	7	



Induction Wok 铝制炒锅

CODE	SIZE (Ø cm)	THICKNESS (mm)
1242528	28	5

Induction Frying Pan

铝制平底煎锅

CODE	SIZE (Ø x h cm)	THICKNESS (mm)
1242620	20 x 5.0	7
1242624	24 x 5.2	7
1242628	28 x 5.8	7
1242632	32 x 6.0	7



Induction Deep Frying Pan

铝制深平底煎锅

CODE	SIZE (Ø x h cm)	THICKNESS (mm)	CAPACITY (lit)
1242724	24 x 8.0	7	2.0
1242728	28 x 8.5	7	3.0



Pyrex Glass Cover

玻璃锅盖

CODE	SIZE (Ø cm)
1242916	16
1242920	20
1242924	24
1242928	28
1242932	32
1242936	36



GOURMET' Fondue Set

铝制迷你火锅

CODE	SIZE (Ø x h cm)	THICKNESS (mm)
1243020	20	6



Grill Pan

铝制平底煎锅 (线条)

CODE	SIZE (Ø x h cm)	THICKNESS (mm)	CAPACITY (lit)
1243126	26 x 26	7	





Grill Pan
铝制平底煎锅 (线条)

CODE	SIZE (Ø cm)	THICKNESS (mm)
1243220	20 x 20	6
1243236	36 x 20	6
1243243	43 x 26	6



Grill Pan
铸铁烤盘

CODE	SIZE (Ø x h cm)	THICKNESS (mm)
1243324	24 x 24	6



Grill Pan
铸铁烤盘

CODE	SIZE (Ø x h cm)	THICKNESS (mm)	CAPACITY (lit)
1243336	23 x 35 x 1.8	6	



Grill Pan
铸铁烤盘

CODE	SIZE (Ø x h cm)	THICKNESS (mm)	CAPACITY (lit)
1243350	28 x 50 x 2	6	

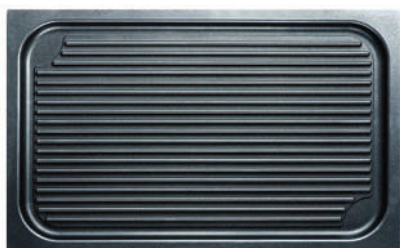

Gastronorm Pan
铝制份数盘

CODE	SIZE (Ø cm)
1243453	53 x 32



Chasseur® offers a selection of superior enamelled cast iron cookware that is manufactured in France. Whether you are a novice or a master chef, Chasseur® enables you to re-create traditional recipes or whip up new dishes using your imagination.



Chasseur® offers a selection of superior enamelled cast iron cookware that is manufactured in France. Whether you are a novice or a master chef, Chasseur® enables you to re-create traditional recipes or whip up new dishes using your imagination.

Round Cast Iron Casserole with Cover 圆形铸铁锅



CODE	SIZE (Ø x h cm)	CAPACITY (lit)
1250110-xx	10 x 9.0	0.35 * flamed orange not available
1250112-xx	12 x 10.0	0.6 * flamed orange not available
1250114-xx	14 x 12.5	0.9 * flamed orange not available
1250116-xx	16 x 13.0	1.4 * flamed orange not available
1250118-xx	18 x 13.0	1.8
1250120-xx	20 x 13.5	2.5
1250122-xx	22 x 15.0	3.2
1250124-xx	24 x 16.0	4.0
1250126-xx	26 x 17.0	5.0
1250128-xx	28 x 18.0	7.4
1250132-xx	32 x 19.0	8.8

* Available Color :

BK
 CV
 When ordering black add **CODE** suffix to item number (example: 1250110-BK)

FO
 RB

Oval Cast Iron Casserole with Cover 椭圆形铸铁锅



CODE	SIZE (l x w x h cm)	CAPACITY (lit)
1250217-xx	17 x 12 x 10	1.0 * flamed orange not available
1250225-xx	25 x 19.5 x 18.5	3.2
1250227-xx	27 x 20.0 x 18.5	4.0
1250231-xx	31 x 26.0 x 17.0	6.0
1250235-xx	35 x 28.0 x 19.0	8.5

* Available Color :

BK
 CV
 When ordering black add **CODE** suffix to item number (example: 1250217-BK)

FO
 RB

Round Shallow Serving Casserole with Cover 圆形铸铁浅锅



CODE	SIZE (Ø x h cm)	CAPACITY (lit)
1250324-xx	24 x 11	1.7
1250330-xx	30 x 12	2.5

* Available Color:

BK
 RB
 When ordering black add **CODE** suffix to item number (example: 1250324-BK)

Rectangular Cast Iron Pate Terrine / Casserole with Cover 长方形铸铁锅



CODE	SIZE (l x w x h cm)	CAPACITY (internal)	CAPACITY (lit)
1250428-xx	31.5 x 11 x 11.5	23.0 x 11	1.0
1250432-xx	36.0 x 11 x 11.5	26.7 x 11	1.2

* Available Color:

BK
 CV
 When ordering black add **CODE** suffix to item number (example: 1250428-BK)

RD

"CARRONDE" Cast Iron Casserole with Cover 铸铁锅



CODE	SIZE (l x w x h cm)	CAPACITY (lit)
1251420	26 x 21 x 15	3.0
1251424	32 x 26 x 17	5.5
1251401	36 x 23 x 6	3.3

* Available Color:

BK

Cast Iron Round "MEDIUM" Targine 塔吉锅

CODE	SIZE (Ø cm)	CAP (lit)
1251824	32 (include handle)	1.5

* Available Color :

■ RD



Cast Iron Chinese Wok with 2-Handle, Flat Base Induction 铸铁炒锅

CODE	SIZE (Ø x h cm)	
1250518-xx	18 x 5.6	mini wok
1250537-xx	37 x 5	

* Available Color :

■ BK ■ CV ■ RB When ordering black add **CODE** suffix to item number (example: 1250518-BK)



Rectangular Cast Iron Gratin / Baking Dish with Wide Handle 长方形铸铁烤盘

CODE	SIZE (l x w x h cm)	(internal)	CAPACITY (lit)
1250701-xx	27.5 x 14 x 4.0	22.5 x 14	0.7
1250702-xx	34.0 x 18 x 5.0	28.0 x 18	1.5
1250703-xx	39.5 x 22 x 5.5	33.5 x 22	2.0

* Available Color :

■ BK ■ CV ■ RD When ordering black add **CODE** suffix to item number (example: 1250701-BK)



Rectangular Cast Iron Gratin / Baking Dish with Narrow Handle 长方形铸铁烤盘

CODE	SIZE (l x w x h cm)	(internal)	CAPACITY (lit)
1250801-xx	40 x 26 x 7	36.5 x 26	4.0
1250803-xx	29.0 x 21.5 x 5.5	29 x 21	2.0

* Available Color :

■ BK ■ CV ■ RD When ordering black add **CODE** suffix to item number (example: 1250801-BK)



Round Cast Iron Gratin Dishes 圆形铸铁烤盘

CODE	SIZE (Ø x h cm)	CAPACITY (lit)
1250915-xx	15 x 5	0.5
1250918-xx	18 x 5	0.7
1250922-xx	22 x 5	1.0

* Available Color :

■ BK ■ CV ■ RD When ordering black add **CODE** suffix to item number (example: 1250915-BK)



Oval Cast Iron Gratin Dishes 椭圆形铸铁烤盘

CODE	SIZE (l x w x h cm)	(internal)	CAPACITY (lit)
1251001-xx	25 x 15.5 x 5.5	20 x 15.5	0.5
1251002-xx	34 x 21.0 x 6.5	27.5 x 21.0	1.2

* Available Color :

■ BK ■ CV ■ RD When ordering black add **CODE** suffix to item number (example: 1251001-BK)





Round Cast Iron Frying Pan with Cast Iron Handle
圆形铸铁平底煎锅

CODE	SIZE (Ø x h)	CAPACITY (lit)
1251121-xx	20 x 5.5	0.7
1251124-xx	26 x 8.0	1.5

* Available Color :

■ BK ■ RD

When ordering black add **CODE** suffix to item number (example: 1251121-BK)



Square Cast Iron "LINED" Grill Pan with Cast Iron Handle
方形烤盘

CODE	SIZE (l x w x h cm)	CAPACITY (lit)
1251250-xx	26 x 26 x 5.5	1.5

* Available Color :

■ BK ■ RD

When ordering black add **CODE** suffix to item number (example: 1251250-BK)



Rectangle Cast Iron "LINED" Grill Pan with 2-Handle
长方形烤盘

CODE	SIZE (l x w x h cm)	CAPACITY (internal)
1251842	42 x 24 x 3	34 x 24

* Available Color :

■ RB



Oval Cast Iron "LINED" Grill Pan with 2-Handle
椭圆形烤盘

CODE	SIZE (l x w x h cm)
1251300	41 x 20 x 3
1251305	53 x 23 x 3



Cast Iron Saucepan with Cover & Wooden Handle
木柄铸铁汁锅

CODE	SIZE (Ø x h cm)	CAPACITY (lit)
1251581-xx	16 x 12	1.2
1251582-xx	18 x 14	1.7

* Available Color :

■ BK ■ RD

When ordering black add **CODE** suffix to item number (example: 1251581-BK)



Cast Iron Round Crepe Pan Griddle with Handle
铸铁薄煎饼锅

CODE	SIZE (Ø cm)
1251601	30 x 4

* Available Color :

■ BK



Fondue Set Cast Iron with Wooden Base
铸铁迷你火锅

CODE	SIZE (Ø x h cm)	CAPACITY (lit)
1251701-xx	20 x 21	1.4

* Available Color :

■ BK ■ RD

When ordering black add **CODE** suffix to item number (example: 1251701-BK)

GOURMET STEEL

Gourmet Steel 188



Cover

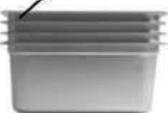

Anti Jamming & Perfect Stacking



Gourmet Steel 188 Pan

- Made of 18/8 stainless steel, AISI 304
- Thickness from 0.7mm to 1.0mm thick
- Conform to Europe GN standard EN631-1
- Anti jamming design eliminates pans from sticking together
- NSF listed

Stainless Steel GN Pan 2/1

2/1 不锈钢份数盆

CODE	DIMENSION (l x w x h cm)	CAP (lit)
1140102	65 x 53 x 2.0	4.5
1140104	65 x 53 x 4.0	10.0
1140106	65 x 53 x 6.5	16.5
1140110	65 x 53 x 10.0	26.0
1140115	65 x 53 x 15.0	40.0

Cover

1141021 65 x 53

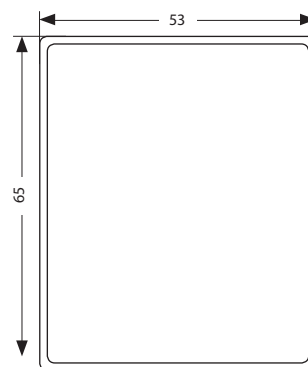

Stainless Steel GN Pan 1/1

1/1 不锈钢份数盆

CODE	DIMENSION (l x w x h cm)	CAP (lit)
1140202	53 x 32.5 x 2.0	1.9
1140204	53 x 32.5 x 4.0	6.0
1140206	53 x 32.5 x 6.5	8.5
1140210	53 x 32.5 x 10.0	13.0
1140215	53 x 32.5 x 15.0	19.5
1140220	53 x 32.5 x 20.0	25.6

Cover

1141011 53 x 32.5

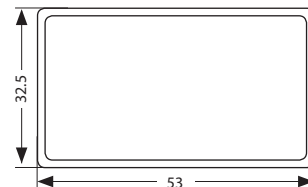

Stainless Steel GN Pan 1/2

1/2 不锈钢份数盆

CODE	DIMENSION (l x w x h cm)	CAP (lit)
1140302	32.5 x 26.5 x 2.0	0.85
1140304	32.5 x 26.5 x 4.0	3.0
1140306	32.5 x 26.5 x 6.5	3.9
1140310	32.5 x 26.5 x 10.0	5.9
1140315	32.5 x 26.5 x 15.0	8.9
1140320	32.5 x 26.5 x 20.0	11.7

Cover

1141012 32.5 x 26.5

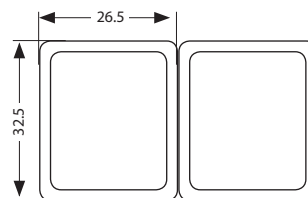

Stainless Steel GN Pan 2/3

2/3 不锈钢份数盆

CODE	DIMENSION (l x w x h cm)	CAP (lit)
1140402	35.3 x 32.5 x 2.0	1.25
1140404	35.3 x 32.5 x 4.0	3.0
1140406	35.3 x 32.5 x 6.5	5.3
1140410	35.3 x 32.5 x 10.0	8.8
1140415	35.3 x 32.5 x 15.0	13.3
1140420	35.3 x 32.5 x 20.0	17.7

Cover

1141023 35.3 x 32.5

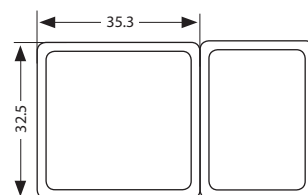

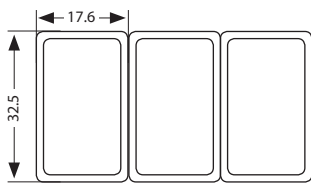

Stainless Steel GN Pan 1/3
1/3 不锈钢份数盆

CODE	DIMENSION (l x w x h cm)	CAP (lit)
1141106	32.5 x 17.6 x 6.5	2.4
1141110	32.5 x 17.6 x 10.0	3.6
1141115	32.5 x 17.6 x 15.0	5.3
1141120	32.5 x 17.6 x 20.0	7.25

Cover
1141013 32.5 x 17.6

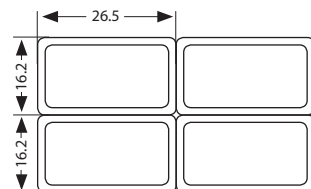

Stainless Steel GN Pan 1/4
1/4 不锈钢份数盆

CODE	DIMENSION (l x w x h cm)	CAP (lit)
1140506	26.5 x 16.2 x 6.5	1.7
1140510	26.5 x 16.2 x 10	2.5
1140515	26.5 x 16.2 x 15	3.7
1140520	26.5 x 16.2 x 20	4.5

Cover
1141014 26.5 x 6.5

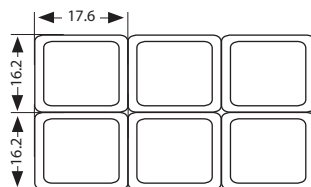

Stainless Steel GN Pan 1/6
1/6 不锈钢份数盆

CODE	DIMENSION (l x w x h cm)	CAP (lit)
1140606	17.6 x 16.2 x 6.5	1.0
1140610	17.6 x 16.2 x 10	1.5
1140615	17.6 x 16.2 x 15	2.2
1140620	17.6 x 16.2 x 20	3.0

Cover
1141016 17.6 x 16.2

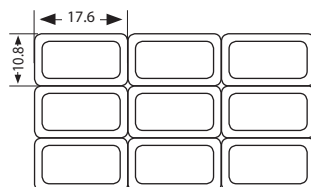

Stainless Steel GN Pan 1/9
1/9 不锈钢份数盆

CODE	DIMENSION (l x w x h cm)	CAP (lit)
1140706	17.6 x 10.8 x 6.5	0.57
1140710	17.6 x 10.8 x 10	0.85
1140715	17.6 x 10.8 x 15	1.5

Cover
1141019 17.6 x 10.8



Stainless Steel "PERFORATED" GN Pan 1/1
1/1 不锈钢有洞份数盆

CODE	DIMENSION (l x w x h cm)	CAP (lit)
1140802	53 x 32.5 x 2	1.9
1140806	53 x 32.5 x 6.5	8.5
1140810	53 x 32.5 x 10	13.0
1140815	53 x 32.5 x 15	19.5
1140820	53 x 32.5 x 20	25.6

Cover
1141011 53 x 32.5



Stainless Steel "PERFORATED" GN Pan 1/2
1/2 不锈钢有洞份数盆

CODE	DIMENSION (l x w x h cm)	CAP (lit)
1140902	32.5 x 26.5 x 2.0	0.85
1140904	32.5 x 26.5 x 4.0	1.7
1140906	32.5 x 26.5 x 6.5	3.9
1140910	32.5 x 26.5 x 10	5.9
1140915	32.5 x 26.5 x 15	8.9
1140920	32.5 x 26.5 x 20	11.7

Cover
1141012 32.5 x 26.5

GOURMET STEEL

Gourmet Steel 201



Regular Stainless Steel Steam Table Pan

- Made of AISI 201 stainless steel
- Thickness form 0.6 to 1.0 mm
- Economy model suitable for general use



Stainless Steel Food Insert Pan 2/1

2/1 不锈钢份数盆

CODE	DIMENSION (l x w x h cm)	CAP (lit)	TYPE
1150102	65 x 53 x 2.0	4.5	
1150104	65 x 53 x 4.0	10.0	
1150106	65 x 53 x 6.5	16.5	
1150110	65 x 53 x 10	26.0	
1150115	65 x 53 x 15	40.0	
1150120	65 x 53 x 20	55.0	

Cover

1151121	65 x 53		
1151421	65 x 53		Slotted

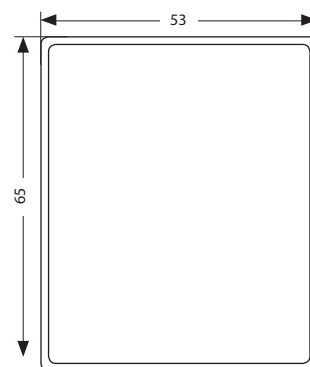

Stainless Steel Food Insert Pan 1/1

1/1 不锈钢份数盆

CODE	DIMENSION (l x w x h cm)	CAP (lit)	TYPE
1150202	53 x 32.5 x 2.0	1.9	
1150204	53 x 32.5 x 4.0	6.0	
1150206	53 x 32.5 x 6.5	8.5	
1150210	53 x 32.5 x 10	13	
1150215	53 x 32.5 x 15	19.5	
1150220	53 x 32.5 x 20	25.6	

Cover

1151111	53x 32.5		
1151411	53 x 32.5		Slotted

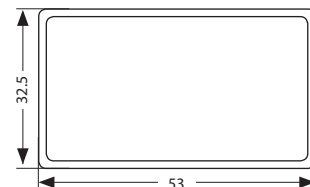

Stainless Steel Food Insert Pan 1/2

1/2 不锈钢份数盆

CODE	DIMENSION (l x w x h cm)	CAP (lit)	TYPE
1150302	32.5 x 26.5 x 2.0	0.85	
1150306	32.5 x 26.5 x 6.5	3.9	
1150310	32.5 x 26.5 x 10	5.9	
1150315	32.5 x 26.5 x 15	8.9	
1150320	32.5 x 26.5 x 20	11.7	

Cover

1151112	32.5 x 26.5		
1151412	32.5 x 26.5		Slotted

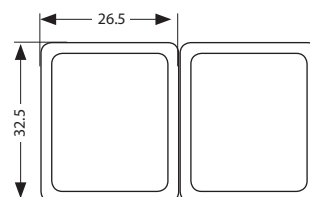

Stainless Steel Food Insert Pan 2/3

2/3 不锈钢份数盆

CODE	DIMENSION (l x w x h cm)	CAP (lit)	TYPE
1150402	35.3 x 32.5 x 2.0	1.25	
1150404	35.3 x 32.5 x 4.0	3.0	
1150406	35.3 x 32.5 x 6.5	5.3	
1150410	35.3 x 32.5 x 10	8.8	
1150415	35.3 x 32.5 x 15	13.3	

Cover

1151123	35.3 x 32.5		
1151423	35.3 x 32.5		Slotted

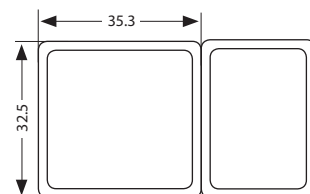

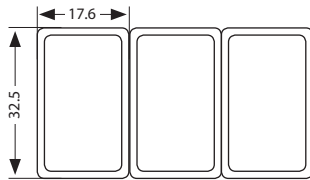

Stainless Steel Food Insert Pan 1/3
1/3 不锈钢份数盆

CODE	DIMENSION (l x w x h cm)	CAP (lit)	TYPE
1150506	32.5 x 17.6 x 6.5	2.4	
1150510	32.5 x 17.6 x 10	3.6	
1150515	32.5 x 17.6 x 15	5.3	
1150520	32.5 x 17.6 x 20	7.25	

Cover

1151113	32.5 x 17.6		
1151413	32.5 x 17.6		Slotted

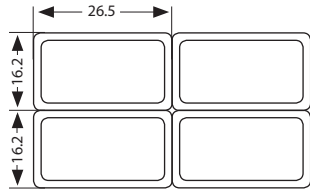

Stainless Steel Food Insert Pan 1/4
1/4 不锈钢份数盆

CODE	DIMENSION (l x w x h cm)	CAP (lit)	TYPE
1150606	26.5 x 16.2 x 6.5	1.7	
1150610	26.5 x 16.2 x 10	2.5	
1150615	26.5 x 16.2 x 15	3.7	
1150620	26.5 x 16.2 x 20	4.5	

Cover

1151114	26.5 x 16.2		
1151414	26.5 x 16.2		Slotted

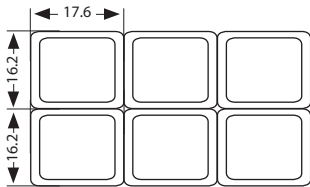

Stainless Steel Food Insert Pan 1/6
1/6 不锈钢份数盆

CODE	DIMENSION (l x w x h cm)	CAP (lit)	TYPE
1150706	17.6 x 16.2 x 6.5	1.0	
1150710	17.6 x 16.2 x 10	1.5	
1150715	17.6 x 16.2 x 15	2.2	
1150720	17.6 x 16.2 x 20	3.0	

Cover

1151116	17.6 x 16.2		
1151416	17.6 x 16.2		Slotted

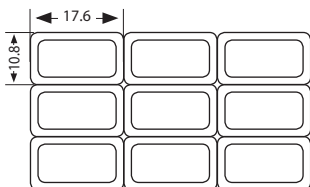

Stainless Steel Food Insert Pan 1/9
1/9 不锈钢份数盆

CODE	DIMENSION (l x w x h cm)	CAP (lit)	TYPE
1150806	17.6 x 10.8 x 6.5	0.57	
1150810	17.6 x 10.8 x 10	0.85	
1150815	17.6 x 10.8 x 15	1.5	

Cover

1151119	17.6 x 10.8		
1151419	17.6 x 10.8		Slotted



Stainless Steel "PERFORATED" Food Insert Pan 1/1
1/1 不锈钢有洞份数盆

CODE	DIMENSION (l x w x h cm)	CAP (lit)	TYPE
1150902	53 x 32.5 x 2.0	1.9	
1150906	53 x 32.5 x 6.5	8.5	
1150910	53 x 32.5 x 10	13	
1150915	53 x 32.5 x 15	19.5	

Cover

1151111	53 x 32.5		
1151411	53 x 32.5		Slotted

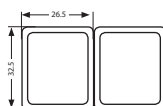

Stainless Steel "PERFORATED" Food Insert Pan 1/2
1/2 不锈钢有洞份数盆

CODE	DIMENSION (l x w x h cm)	CAP (lit)	TYPE
1151002	32.5 x 26.5 x 2.0	0.85	
1151006	32.5 x 26.5 x 6.5	3.9	
1151010	32.5 x 26.5 x 10	5.9	
1151015	32.5 x 26.5 x 15	8.9	

Cover

1151112	32.5 x 26.5		
1151412	32.5 x 26.5		Slotted

Stainless Steel "PERFORATED" Food Insert Pan 2/3 2/3 不锈钢有洞份数盆

GOURMET
STEEL

CODE	DIMENSION (l x w x h cm)	CAP (lit)	TYPE
1151223	35.3 x 32.5 x 6.5	3.5	
Cover			
1151123	35.3 x 32.5		
1151423	35.3 x 32.5		Slotted

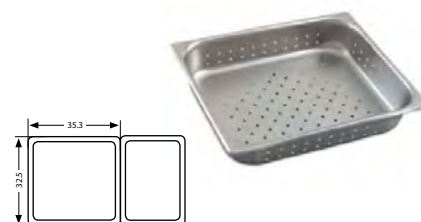

Stainless Steel Long Insert Food Pan 2/4 2/4 不锈钢份数盆盖

GOURMET
STEEL

CODE	DIMENSION (l x w x h cm)	CAP (lit)	TYPE
1151206	53 x 16.2 x 6.5	3.5	
1151210	53 x 16.2 x 10	5.4	
1151215	53 x 16.2 x 15	7.8	
Cover			
1151120	53 x 16.2		
1151420	53 x 16.2		Slotted

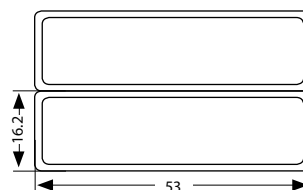

Stainless Steel Divided Insert Food Pan 1/1 1/1 不锈钢两格有洞份数盆

GOURMET
STEEL

CODE	DIMENSION (l x w x h cm)	TYPE
1151306	53 x 32.5 x 6.5	
Cover		
1151111	53 x 32.5	
1151411	53 x 32.5	Slotted



Wire Pan Grate with Foot 有脚放盆内网

CODE	DIMENSION (l x w x h cm)	SIZE
1160111	45.7 x 25.4 x 2.2	1/1
1160113	25.4 x 12.7 x 2.2	1/3
1160112	25.4 x 20.3 x 2.2	1/2
1160121	62.2 x 41.9 x 3.2	2/1



Stainless Steel False Bottom (Perforated) 排水盘

CODE	SIZE
1160211	1/1
1160212	1/2



Stainless Steel Long Adaptor Bar 不锈钢改装条

CODE	DIMENSION (l cm)
1160352	52.0
1160326	26.6



Stainless Steel Ice Cream Food Pan / Tub 不锈钢改装条

PIAZZA

CODE	DIMENSION (l cm)	CAP (lit)
1160400	16 x 36 x 11.6	5





Steam Table Inserts Only 无盖钢汤桶

CODE	FITS OPENING (Ø cm)	CAP (lit)	DEPTH (cm)
1170102	12.7	2.2	14
1170104	16.5	3.9	18.1
1170107	21.5	6.7	24.1
1170111	26.6	10.4	28.9

Cover

1170202	12.7	Fits 1170102
1170204	16.5	Fits 1170104
1170207	21.5	Fits 1170107
1170211	26.6	Fits 1170111



Stainless Steel "HINGED" Cover 内胆半揭盖

CODE	DIMENSION (Ø cm)	FITS
1170307	25	1170107 Steam Table
1170311	29	1170111 Steam Table



Stainless Steel Bain Marie Pots 无盖不锈钢酱料桶

CODE	FITS OPENING (Ø cm)	CAP (lit)	DEPTH (cm)
1170401	10.4	1.2	12.0
1170402	12.0	1.9	14.0
1170403	15.5	3.3	17.5
1170404	16.5	4.0	18.0
1170406	18.4	5.7	20.0
1170408	20.0	7.8	22.0
1170412	22.8	11.4	27.0

Bain Marie Pot Cover 钢酱料桶盖



CODE	DIMENSION (Ø cm)	FIT
1170501	10.4	1170401
1170502	12.0	1170402
1170503	15.5	1170403
1170504	16.5	1170404
1170506	18.4	1170406
1170508	20.0	1170408
1170512	22.8	1170412

Stainless Steel Square Deep Kitchen Pot 方形不锈钢桶



CODE	SIZE (Ø cm)	CAP (lit)
1120208	8	0.46
1120210	10	0.9
1120212	12	1.6
1120214	14	2.5
1120216	16	3.7
1120218	18	5.5
1120220	20	7.5
1120222	22	10.3
1120224	24	13.7
1120227	27	19
1120230	30	26



Stainless Steel Square Shallow Kitchen Pot 方形浅不锈钢桶



CODE	SIZE (Ø cm)	CAP (lit)
1120314	14	1.4
1120318	18	2.1



Stainless Steel "ABC" Bain Marie with Handle 不锈钢“ABC”方形有柄储物桶

CODE	SIZE (l x w x h cm)
1130107	24 x 24 x 7.5
1130116	24 x 24 x 16.0
1130123	24 x 24 x 23.5

Cover
1130425 24 x 24



Stainless Steel "ABC" Bain Marie with Handle 不锈钢“ABC”方形有柄储物桶

CODE	SIZE (l x w x h cm)
1130207	15.5 x 15.5 x 7.5
1130216	15.5 x 15.5 x 16.0
1130223	15.5 x 15.5 x 23.5

Cover
1130416 15.5 x 15.5



Stainless Steel "ABC" Bain Marie with Handle 不锈钢“ABC”方形有柄储物桶

CODE	SIZE (l x w x h cm)
1130305	15.5 x 10.5 x 5.5
1130316	15.5 x 10.6 x 16.0
1130307	15.5 x 10.6 x 7.5

Cover
1130411 15.5 x 10.6



Camwear® Polycarbonate Food Pans

Store, transport and serve all in one pan. Camwear food pans are made from durable polycarbonate that will not crack, bend or dent. Precisely designed to Gastronorm GN specifications, with a large radius bottom to reduce food waste. At half the cost of stainless steel, Camwear pans keep contents as cold as metal pans with less condensation. Pans stack neatly without wedging or sticking.

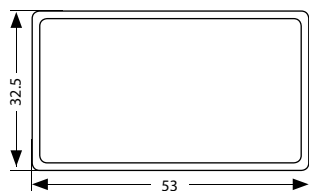

* Available Color:

□ 135 ■ 110

Polycarbonate Food Insert Pans 1/1 1/1 胶份数盆 (透明)

CODE	DIMENSION (l x w x h cm)	CAP (lit)	TYPE
1180106-xx	53 x 32.5 x 6.5	8.5	
1180110-xx	53 x 32.5 x 10	13.0	
1180115-xx	53 x 32.5 x 15	19.5	
1180120-xx	53 x 32.5 x 20	25.6	

Cover

1180711	53 x 32.5	Flat with handle
1180811	53 x 32.5	Notched with handle
1180911	53 x 32.5	GripLid
1181011	53 x 32.5	Flat
1181211	53 x 32.5	Seal Cover

Drain Shelf

1181111	53 x 32.5	
---------	-----------	--

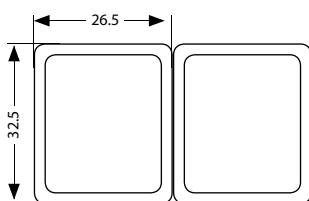

* Available Color:

□ 135 ■ 110

Polycarbonate Food Insert Pans 1/2 1/2 胶份数盆 (透明)

CODE	DIMENSION (l x w x h cm)	CAP (lit)	TYPE
1180206-xx	32.5 x 26.5 x 6.5	3.9	
1180210-xx	32.5 x 26.5 x 10	5.9	
1180215-xx	32.5 x 26.5 x 15	8.9	
1180220-xx	32.5 x 26.5 x 20	11.7	

Cover

1180712	32.5 x 26.5	Flat with handle
1180812	32.5 x 26.5	Notched with handle
1180912	32.5 x 26.5	Notched FlipLid
1181012	32.5 x 26.5	Flat
1181212	32.5 x 26.5	Seal Cover
1181312	32.5 x 26.5	GripLid
1181412	32.5 x 26.5	FlipLip

Drain Shelf

1181112	32.5 x 26.5	
---------	-------------	--



Polycarbonate Food Insert Pans 1/3

1/3 胶份数盆 (透明)

CODE	DIMENSION (l x w x h cm)	CAP (lit)	TYPE
1180306-xx	32.5 x 17.6 x 6.5	2.4	
1180310-xx	32.5 x 17.6 x 10	3.6	
1180315-xx	32.5 x 17.6 x 15	5.3	
1180320-xx	32.5 x 17.6 x 20	7.25	

Cover

1180713	32.5 x 17.6	Flat with handle
1180813	32.5 x 17.6	Notched with handle
1180913	32.5 x 17.6	Notched FlipLid
1181013	32.5 x 17.6	Flat
1181213	32.5 x 17.6	Seal Cover
1181413	32.5 x 17.6	GripLid
1181513	32.5 x 17.6	FlipLid

Drain Shelf

1181113	32.5 x 17.6	
---------	-------------	--

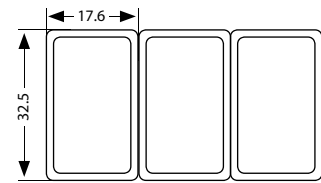

* Available Color:



Polycarbonate Food Insert Pans 1/4

1/4 胶份数盆 (透明)

CODE	DIMENSION (l x w x h cm)	CAP (lit)	TYPE
1180406-xx	26.5 x 16.2 x 6.5	1.7	
1180410-xx	26.5 x 16.2 x 10	2.5	
1180415-xx	26.5 x 16.2 x 15	3.7	

Cover

1180714	26.5 x 16.2	Flat with handle
1180814	26.5 x 16.2	Notched with handle
1181014	26.5 x 16.2	Flat
1181214	26.5 x 16.2	Seal Cover

Drain Shelf

1181114	26.5 x 16.2	
---------	-------------	--

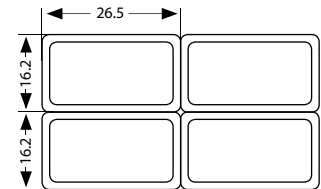

* Available Color:

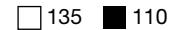

Polycarbonate Food Insert Pans 1/6

1/6 胶份数盆 (透明)

CODE	DIMENSION (l x w x h cm)	CAP (lit)	TYPE
1180506-xx	17.6 x 16.2 x 6.5	1.0	
1180510-xx	17.6 x 16.2 x 10	1.5	
1180515-xx	17.6 x 16.2 x 15	2.2	

Cover

1180716	17.6 x 16.2	Flat with handle
1180816	17.6 x 16.2	Notched with handle
1180916	17.6 x 16.2	Notched FlipLid
1181016	17.6 x 16.2	Flat
1181216	17.6 x 16.2	Seal Cover
1181316	17.6 x 16.2	GripLid
1181416	17.6 x 16.2	FlipLid

Drain Shelf

1181116	17.6 x 16.2	
---------	-------------	--

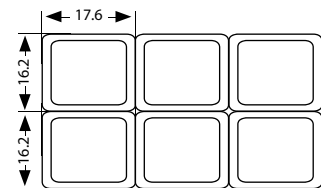

* Available Color:

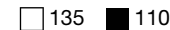

Polycarbonate Food Insert Pans 1/8 1/8 胶份数盆 (透明)



* Available Color:



CODE	DIMENSION (l x w x h cm)	CAP (lit)	TYPE
1181406-xx	16.12 x 13.17 x 6.5	0.7	
1181410-xx	16.12 x 13.17 x 10	1.0	
1181415-xx	16.12 x 13.17 x 15	1.5	
Cover			
1180718	16.12 x 13.17		Flat with handle
1180818	16.12 x 13.17		Notched with handle
1181018	16.12 x 13.17		Flat

Drain Shelf

1181118 16.12 x 13.17

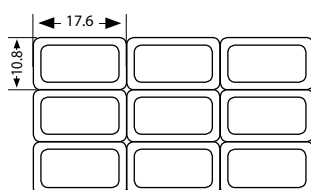

* Available Color:



Polycarbonate Food Insert Pans 1/9 1/9 胶份数盆 (透明)

CODE	DIMENSION (l x w x h cm)	CAP (lit)	TYPE
1180606-xx	17.6 x 10.8 x 6.5	0.57	
1180610-xx	17.6 x 10.8 x 10	0.85	
Cover			
1180919	17.6 x 10.8		Flat Notched
1181019	17.6 x 10.8		Flat
1181219	17.6 x 10.8		Seal Cover
Drain Shelf			
1181119	17.6 x 10.8		

Polycarbonate Colander Pans 排水盆



CODE	DIMENSION	FITS	
1181313	53.0 x 32.5 x 7.6	1/1 x 4" Pan	Full Size
1181315	53.0 x 32.5 x 12.7	1/1 x 6" Pan	Full Size
1181323	32.5 x 26.5 x 7.6	1/2 x 4" Pan	Half Size
1181325	32.5 x 26.5 x 12.7	1/2 x 6" Pan	Half Size
1181333	32.5 x 17.6 x 7.6	1/3 x 4" Pan	One Third Size
1181335	32.5 x 17.6 x 12.7	1/3 x 6" Pan	One Third Size
1181363	17.6 x 16.2 x 7.6	1/6 x 4" Pan	One Sixth Size
1181365	17.6 x 16.2 x 12.7	1/6 x 6" Pan	One Sixth Size



Flat cover with handle



Notched cover with handle



FlipLid cover



Notched FlipLid cover



Flat Notched cover



GripLid cover

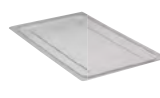

Full Flat cover



Seal cover



Drain shelf

X-Pans™ High Heat Food Pans

Cambro® High Heat X-Pans™ withstand and adapt to different temperatures cold to hot, thus expanding functionality and reducing unnecessary handling. The new temperature tolerance on High Heat X-Pans makes them ideal for high-heat cooking and reheating applications. High Heat X-Pans are available in Onyx and Sandstone, designed to enhance merchandising of food, making it more appealing for deli and service lines.



- Ideal for use in microwaves, steam tables, ovens and hot holding applications.
- Reduces handling – high heat food pans can go from prep, to cooler, to oven to hot holding application at temperatures ranging from -40° to 375°F (-40° to 190°C).
- New colors designed to enhance merchandising of food, making it more appealing for deli and service lines.
- Non-stick smooth interior surface increases yields and promotes easy cleaning.
- Pans stack neatly, without wedging or sticking.
- Commercial dishwasher safe.

*** Available Color:**

■ Sandstone (ST) ■ Onyx (ON)

When ordering Black Pans add suffix **CODE** to item number (example: 1200106-ON)

High Heat Food Pan 1/1 1/1 耐高温胶份数盆 (透明)

CODE	DIMENSION (l x w x h cm)	CAP (lit)	TYPE
1200106	53 x 32.5 x 6.5	8.5	
1200110	53 x 32.5 x 10	13.0	
1200115	53 x 32.5 x 15	19.5	
1200120	53 x 32.5 x 20	25.6	

Cover

1210111	53 x 32.5	Flat
1210211	53 x 32.5	Flat with handle

Drain Shelf

1220211	53 x 32.5
---------	-----------

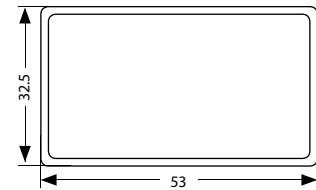

High Heat Food Pan 1/2 1/2 耐高温胶份数盆 (透明)

CODE	DIMENSION (l x w x h cm)	CAP (lit)	TYPE
1200206	32.5 x 26.5 x 6.5	3.9	
1200210	32.5 x 26.5 x 10	5.9	
1200215	32.5 x 26.5 x 15	8.9	
1200220	32.5 x 26.5 x 20	11.7	

Cover

1210112	32.5 x 26.5	Flat
1210212	32.5 x 26.5	Flat with handle

Drain Shelf

1220212	32.5 x 26.5
---------	-------------

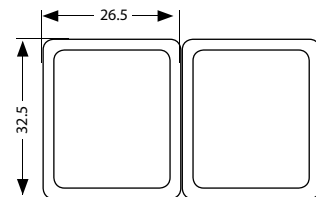

High Heat Food Pan 1/3 1/3 耐高温胶份数盆 (透明)

CODE	DIMENSION (l x w x h cm)	CAP (lit)	TYPE
1200306	32.5 x 17.6 x 6.5	2.4	
1200310	32.5 x 17.6 x 10	3.6	
1200315	32.5 x 17.6 x 15	5.3	
1200320	32.5 x 17.6 x 20	7.25	

Cover

1210113	32.5 x 17.6	Flat
1210213	32.5 x 17.6	Flat with handle

Drain Shelf

1220213	32.5 x 17.6
---------	-------------

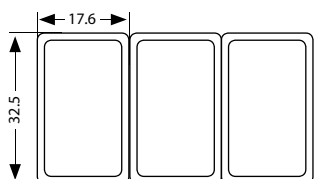

High Heat Food Pan 1/4 1/4 耐高温胶份数盆 (透明)

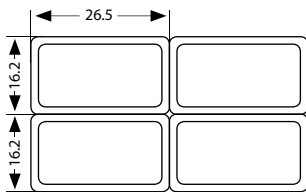

CODE	DIMENSION (l x w x h cm)	CAP (lit)	TYPE
------	-----------------------------	--------------	------

1200406	26.5 x 16.2 x 6.5	1.7	
1200410	26.5 x 16.2 x 10	2.5	
1200415	26.5 x 16.2 x 15	3.7	

Cover

1210114	26.5 x 16.2		Flat
1210214	26.5 x 16.2		Flat with handle

Drain Shelf

1220214	26.5 x 16.2		
---------	-------------	--	--

High Heat Food Pan 1/6 1/6 耐高温胶份数盆 (透明)

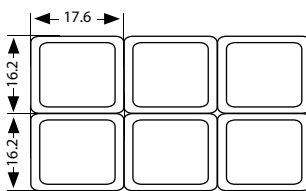

CODE	DIMENSION (l x w x h cm)	CAP (lit)	TYPE
------	-----------------------------	--------------	------

1200506	17.6 x 16.2 x 6.5	1.0	
1200510	17.6 x 16.2 x 10	1.5	
1200515	17.6 x 16.2 x 15	2.2	

Cover

1210116	17.6 x 16.2		Flat
1210216	17.6 x 16.2		Flat with handle

Drain Shelf

1220216	17.6 x 16.2		
---------	-------------	--	--

High Heat Food Pan 1/8 1/8 耐高温胶份数盆 (透明)

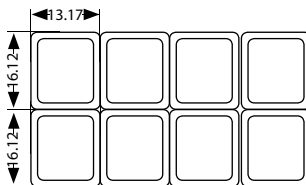

CODE	DIMENSION (l x w x h cm)	CAP (lit)	TYPE
------	-----------------------------	--------------	------

1200706	16.12 x 13.17 x 6.5	0.7	
1200710	16.12 x 13.17 x 10	1.0	
1200715	16.12 x 13.17 x 15	1.5	

Cover

1210118	16.12 x 13.17		Flat
1210218	16.12 x 13.17		Flat with handle

Drain Shelf

1220218	16.12 x 13.17		
---------	---------------	--	--

High Heat Food Pan 1/9 1/9 耐高温胶份数盆 (透明)

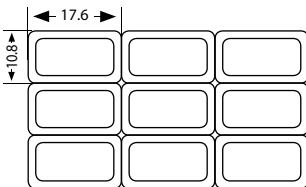

CODE	DIMENSION (l x w x h cm)	CAP (lit)	TYPE
------	-----------------------------	--------------	------

1200606	17.6 x 10.8 x 6.5	0.57	
1200610	17.6 x 10.8 x 10	0.85	

Cover

1210119	17.6 x 10.8		Flat
---------	-------------	--	------

Drain Shelf

1220219	17.6 x 10.8		
---------	-------------	--	--



Flat cover



Flat cover with handle



Drain Shelf

Translucent Polypropylene Food Pans

- An economical choice for storing food.
- Translucent polypropylene material provides content visibility and high chemical resistance.
- Withstands temperature ranges from -40°C to 70°C.
- Meets Gastronorm GN food pan specifications.
- Non-stick smooth interior surfaces promotes easy cleaning.



Polypropylene Food Pan 1/1 1/1 胶份数盆 (半透明)

CODE	DIMENSION (l x w x h cm)	CAP (lit)	TYPE
1300110	53 x 32.5 x 10	13.0	
1300115	53 x 32.5 x 15	19.5	

Cover

1181211 53 x 32.5

1310211 53 x 32.5

Seal Cover

Cover with handle

Drain Shelf

1320211 53 x 32.5



Polypropylene Food Pan 1/2 1/2 胶份数盆 (半透明)

CODE	DIMENSION (l x w x h cm)	CAP (lit)	TYPE
1300206	32.5 x 26.5 x 6.5	5.9	
1300215	32.5 x 26.5 x 15	8.9	

Cover

1181212 32.5 x 26.5

1310212 32.5 x 26.5

Seal Cover

Cover with handle

Drain Shelf

1320212 32.5 x 26.5

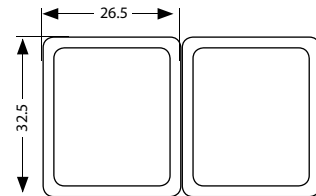

Polypropylene Food Pan 1/3 1/3 胶份数盆 (半透明)

CODE	DIMENSION (l x w x h cm)	CAP (lit)	TYPE
1300306	32.5 x 17.6 x 6.5	2.4	
1300310	32.5 x 17.6 x 10	3.6	
1300315	32.5 x 17.6 x 15	5.3	

Cover

1181213 32.5 x 17.6

1310213 32.5 x 17.6

1310313 32.5 x 17.6

Seal Cover

Cover with handle

Notched cover with handle

Drain Shelf

1320213 32.5 x 17.6

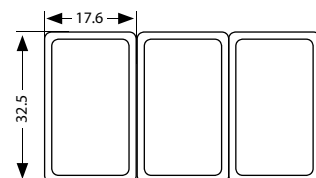

Notched cover with handle



Cover with handle



Seal cover

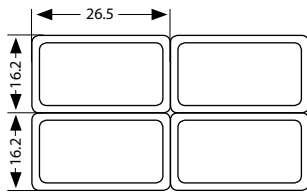

Polypropylene Food Pan 1/4 1/4 胶份数盆 (半透明)

CODE	DIMENSION (l x w x h cm)	CAP (lit)	TYPE
1300406	26.5 x 16.2 x 6.5	1.7	
1300410	26.5 x 16.2 x 10	2.5	
1300415	26.5 x 16.2 x 15	3.7	

Cover

1181214	26.5 x 16.2	Seal Cover
1310214	26.5 x 16.2	Cover with handle

Drain Shelf

1320214	26.5 x 16.2
---------	-------------

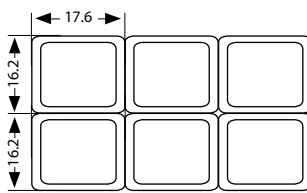

Polypropylene Food Pan 1/6 1/6 胶份数盆 (半透明)

CODE	DIMENSION (l x w x h cm)	CAP (lit)	TYPE
1300506	17.6 x 16.2 x 6.5	1.0	
1300510	17.6 x 16.2 x 10	1.5	
1300515	17.6 x 16.2 x 15	2.2	

Cover

1181216	17.6 x 16.2	Seal Cover
1310216	17.6 x 16.2	Cover with handle
1310316	17.6 x 16.2	Notched with handle

Drain Shelf

1320216	17.6 x 16.2
---------	-------------

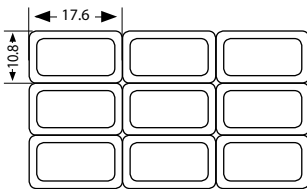

Polypropylene Food Pan 1/9 1/9 胶份数盆 (半透明)

CODE	DIMENSION (l x w x h cm)	CAP (lit)	TYPE
1300606	17.6 x 10.8 x 6.5	0.57	
1300610	17.6 x 10.8 x 10	0.85	

Cover

1181219	17.6 x 10.8	Seal Cover
1310219	17.6 x 10.8	Flat Cover

Drain Shelf

1320219	17.6 x 10.8
---------	-------------



Cover with handle



Full Flat cover



Seal cover



Notched cover with handle





UNICA's new range of PP Gastronorm Pans provides greater flexibility with its range of sizes and depths. Covers provide secure storage for transport and stacking. Our covers can also be used with major brands of stainless steel & polycarbonate pans. Level indicators on side makes serving and measuring a breeze. Comes in natural pans and white lids. 6 colour clips on tags provides identification



* Available Color:

- BL ■ BK
- GR ■ GY
- RD WH

* When ordering blue Pans add suffix **CODE** to item number (example: 1190106-BL)

PP Plastic Food Pan 1/1 1/1份数胶盆

CODE	DIMENSION (l x w x h cm)	CAP (lit)	TYPE
1190106	53 x 32.5 x 6.5	8.5	
1190110	53 x 32.5 x 10	13	
1190115	53 x 32.5 x 15	19.5	
1190120	53 x 32.5 x 20	25.6	
Cover			
1190711-xx	53 x 32.5		
Drain Shelf			
1190811	53 x 32.5		

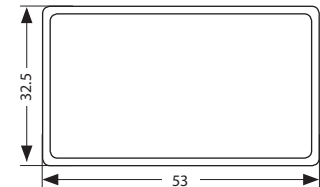

PP Plastic Food Pan 1/2 1/2份数胶盆

CODE	DIMENSION (l x w x h cm)	CAP (lit)	TYPE
1190206	32.5 x 26.5 x 6.5	3.9	
1190210	32.5 x 26.5 x 10	5.9	
1190215	32.5 x 26.5 x 15	8.9	
1190220	32.5 x 26.5 x 20	11.7	
Cover			
1190712-xx	32.5 x 26.5		
Drain Shelf			
1190812	32.5 x 26.5		

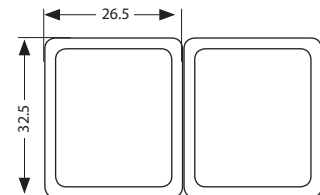

Cover



Drain Shelf

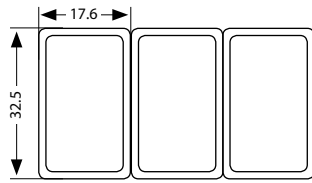

PP Plastic Food Pan 1/3 1/3 份数胶盆

CODE	DIMENSION (l x w x h cm)	CAP (lit)	TYPE
1190306-xx	32.5 x 17.6 x 6.5	2.4	
1190310-xx	32.5 x 17.6 x 10	3.6	
1190315-xx	32.5 x 17.6 x 15	5.3	
1190320-xx	32.5 x 17.6 x 20	7.25	

Cover

1190713 32.5 x 17.6

Drain Shelf

1190813 32.5 x 17.6

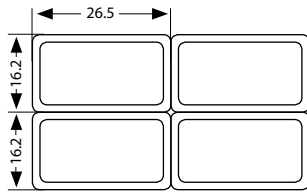

PP Plastic Food Pan 1/4 1/4 份数胶盆

CODE	DIMENSION (l x w x h cm)	CAP (lit)	TYPE
1190406-xx	26.5 x 16.2 x 6.5	1.7	
1190410-xx	26.5 x 16.2 x 10	2.5	
1190415-xx	26.5 x 16.2 x 15	3.7	

Cover

1190714 26.5 x 16.2

Drain Shelf

1190814 26.5 x 16.2

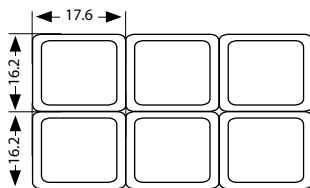

PP Plastic Food Pan 1/6 1/6 份数胶盆

CODE	DIMENSION (l x w x h cm)	CAP (lit)	TYPE
1190506-xx	17.6 x 16.2 x 6.5	1.0	
1190510-xx	17.6 x 16.2 x 10	1.5	
1190515-xx	17.6 x 16.2 x 15	2.2	

Cover

1190716 17.6 x 16.2

Drain Shelf

1190816 17.6 x 16.2

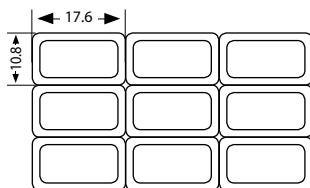

PP Plastic Food Pan 1/9 1/9 份数胶盆

CODE	DIMENSION (l x w x h cm)	CAP (lit)	TYPE
1190606-xx	17.6 x 10.8 x 6.5	0.57	
1190610-xx	17.6 x 10.8 x 10	0.85	

Cover

1190719 17.6 x 10.8



Cover



Drain Shelf



Kitchenware



KITCHENWARE

Stainless Steel Rectangular Pan 不锈钢长方形物料盆



Deep
深



Medium
浅



Perforated
浅式带洞

CODE	SIZE (l x w x h cm)	TYPE
2010240	15.5 x 12.5 x 7.0	40
2010236	18.0 x 13.5 x 7.3	36
2010230	21.0 x 17.0 x 7.5	30
2010221	25.0 x 19.5 x 8.2	21
2010218	26.5 x 20.5 x 8.4	18
2010215	29.5 x 23.0 x 8.8	15
2010212	32.5 x 25.0 x 8.9	12
2010210	35.0 x 27.0 x 9.1	10
2010208	41.0 x 29.5 x 10.4	8
2010206	48.0 x 33.5 x 10.7	6

CODE	SIZE (l x w x h cm)	TYPE
2010140	15.5 x 12.5 x 2.5	40
2010136	18.0 x 13.5 x 2.8	36
2010130	21.0 x 17.0 x 3.0	30
2010121	25.0 x 19.5 x 3.8	21
2010118	26.5 x 20.5 x 4.0	18
2010115	29.5 x 23.0 x 4.5	15
2010112	32.5 x 25.0 x 5.0	12
2010110	35.0 x 27.0 x 6.0	10
2010108	41.0 x 29.5 x 6.5	8
2010106	48.0 x 33.5 x 8.0	6
2010104	55.2 x 37.0 x 10.0	4
2010103	63.7 x 41.4 x 11.8	3

CODE	SIZE (l x w x h cm)	TYPE
2010336	18.0 x 13.5 x 2.8	36
2010330	21.0 x 17.0 x 3.0	30
2010321	25.0 x 19.5 x 3.8	21
2010318	26.5 x 20.5 x 4.0	18
2010315	29.5 x 23.0 x 4.5	15
2010312	32.5 x 25.0 x 5.0	12
2010310	35.0 x 27.0 x 6.0	10
2010308	41.0 x 29.5 x 6.5	8
2010306	48.0 x 33.5 x 8.0	6

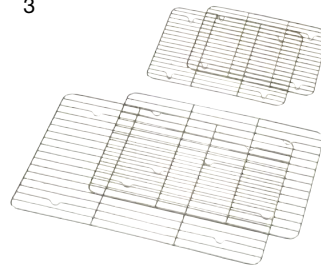

Rectangular Shallow Cake Tray 不锈钢长方形浅蛋糕托盘



CODE	SIZE (l x w x h cm)	TYPE
2010430	22.0 x 15.5 x 1.6	30
2010421	29.0 x 20.0 x 2.0	21
2010415	32.0 x 23.5 x 2.0	15
2010412	35.0 x 25.0 x 2.0	12
2010410	37.0 x 29.0 x 2.5	10
2010408	42.0 x 32.0 x 2.5	8
2010406	47.0 x 36.0 x 2.5	6
2010405	51.0 x 41.5 x 2.6	5

Stainless Steel Net 不锈钢长方形网



CODE	SIZE (w x l x h cm)	FITS TYPE OF TRAY
2030334	56.5 x 34.0 x 1.7	3
2030331	49.0 x 31.0 x 1.7	4
2030328	43.0 x 28.5 x 1.7	6
2030325	36.5 x 25.0 x 1.7	8
2030323	31.5 x 23.0 x 1.7	10
2030321	28.5 x 21.5 x 1.7	12
2030319	26.0 x 19.5 x 1.7	15

Economy Stainless Steel Pan 不锈钢托盘



CODE	SIZE (l x w x h cm)
2010625	25 x 19 x 5.0
2010630	30 x 24 x 5.0
2010635	35 x 27 x 5.0
2010640	40 x 30 x 5.0

Rectangular Shallow Pan 浅形不锈钢长形托盘



CODE	SIZE (l x w x h cm)	TYPE
2010818	25.2 x 19.1 x 2.5	18
2010815	28.4 x 21.9 x 2.5	15
2010812	30.8 x 23.6 x 2.5	12
2010810	33.8 x 25.6 x 2.5	10
2010808	39.5 x 27.0 x 2.0	8
2010806	45.5 x 32.0 x 2.0	6
2010804	56.0 x 35.0 x 2.0	4
2010803	56.0 x 40.0 x 2.0	3

GOURMET
STEEL

Rectangular Pan 不锈钢托盘



CODE	SIZE (l x w x h cm)	TYPE
2010718	25.2 x 19.1 x 4.3	18
2010715	28.4 x 21.9 x 5.0	15
2010712	30.8 x 23.6 x 5.3	12
2010710	33.8 x 25.6 x 6.1	10
2010708	40.2 x 27.5 x 6.4	8
2010706	46.3 x 32.0 x 8.0	6
2010704	55.0 x 37.0 x 9.0	4
2010703	63.5 x 41.0 x 10	3

GOURMET
STEEL

Stainless Steel Preparation Tray

不锈钢托盘

CODE	SIZE (l x w x h cm)	TYPE
2011701	15 x 28.5 x 1.3	Rectangle
2011702	17.5 x 24.5 x 2.0	Rectangle
2011703	13.5 x 18.5 x 2.0	Rectangle
2011801	21.5 x 21.5 x 1.0	Square



Non Stick Roasting Pan

不粘底烤盆



CODE	SIZE (l x w x h cm)	THICKNESS (mm)
2011040	40 x 32 x 8	4
2011045	45 x 36 x 8	4



Non-Stick Roasting Pan

不粘底烤盆



CODE	SIZE (l x w x h cm)	THICKNESS (mm)
2011340	40 x 32 x 8	4
2011345	45 x 36 x 8	4

Aluminium Thick Roasting Pan with Standing Handle

双柄铝厚烤盆



CODE	SIZE (l x w x h cm)	THICKNESS (mm)
2010930	30 x 30 x 6.5	4
2010935	35 x 25 x 6.5	4
2010940	40 x 32 x 8.0	4
2010945	45 x 36 x 8.0	4
2010950	50 x 40 x 8.0	4
2010955	55 x 45 x 8.0	4



Stainless Steel Non-Stick Roasting Pan

不粘底烤盆



CODE	SIZE (l x w cm)	CAP (lit)
2011535	40 x 35 x 8	10.5
2011540	50 x 40 x 8	15.5
2011545	60 x 45 x 10	26.0



Stainless Steel Roasting Pan

烤盆



CODE	SIZE (l x w cm)	CAP (lit)
2011435	40 x 35 x 8	10.5
2011440	50 x 40 x 8	15.5
2011445	60 x 45 x 10	26.0

Roasting Pan Lid

烤盆盖



CODE	SIZE (l x w cm)
2011635	40 x 35
2011640	50 x 40
2011645	60 x 45

Baking Tray, Embossed Pan (Roll Edge) 长方形铝托盘 (滚边)

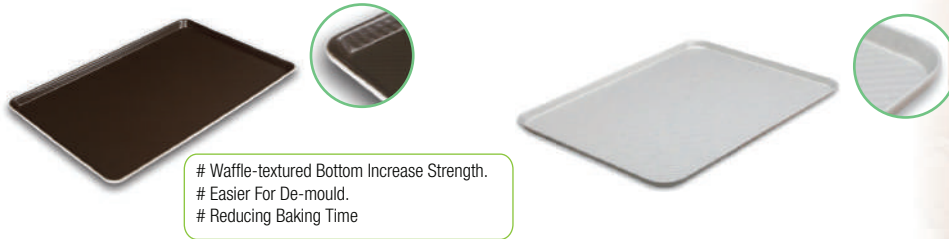

Waffle-textured Bottom Increase Strength.
Easier For De-mould.
Reducing Baking Time

60x40x2 cm Height

CODE	SIZE (l x w x h cm)	THICKNESS	TYPE	REMARK
2020101	60 x 40 x 2.0	1.2	Non-Stick 不粘	SN1318
2020201	60 x 40 x 2.0	1.2	Standard 铝合金	SN1330

40x30x1.2 cm Height

CODE	SIZE (l x w x h cm)	THICKNESS	TYPE	REMARK
2020102	40 x 30 x 1.2	1.2	Non-Stick 不粘	SN1314
2020202	40 x 30 x 1.2	1.2	Standard 铝合金	SN1313

Aluminium Baking Tray (Angled Edge) 长方形铝托盘



60x40x2 cm Height

CODE	SIZE (l x w x h cm)	THICKNESS	TYPE	REMARK
2020500	60 x 40 x 2	1.5	Non-Stick 不粘	SN1072
2020600	60 x 40 x 2	1.5	Standard 铝合金	SN1071

Baking Tray. Al. Steel Plate 长方形铝托盘



60x40x3 cm Height

CODE	SIZE (l x w x h cm)	THICKNESS	TYPE	REMARK
2020800	60 x 40 x 3	0.7	Non-Stick 不粘	SN1078
2020700	60 x 40 x 3	0.7	Standard 铝合金	SN1077

60x40x5 cm Height

CODE	SIZE (l x w x h cm)	THICKNESS	TYPE	REMARK
2021201	60 x 40 x 5	0.7	Non-Stick 不粘	SN1080
2021301	60 x 40 x 5	0.7	Standard 铝合金	SN1079

67.5x43.5x2.5 cm Height

CODE	SIZE (l x w x h cm)	THICKNESS	TYPE	REMARK
2020801	67.5 x 43.5 x 2.5	0.7	Non-Stick 不粘	SN1030
2020701	67.5 x 43.5 x 2.5	0.7	Standard 铝合金	SN1036





Perforated Aluminium Baking Tray 有洞长方形铝托盘



CODE	SIZE (l x w x h cm)	REMARK
2020900	60 x 40 x 2	SN1073

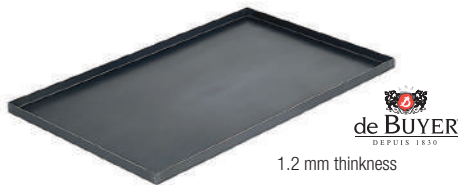

Blue Steel Baking Tray (Straight Edge) 铁烤盘

CODE	SIZE (l x w x h cm)	TYPE
2030453	53.0 x 32.5 x 2	1 / 1
2030465	65.0 x 53.0 x 2	2 / 1
2030440	40.0 x 30.0 x 2	40 x 30
2030460	60.0 x 40.0 x 2	60 x 40



Stainless Steel Baking Tray (Oblique Edge) 钢烤盘

CODE	SIZE (l x w x h cm)	TYPE
2030353	53.0 x 32.5 x 1	1 / 1
2030365	65.0 x 53.0 x 1	2 / 1
2030340	40.0 x 30.0 x 1	40 x 30

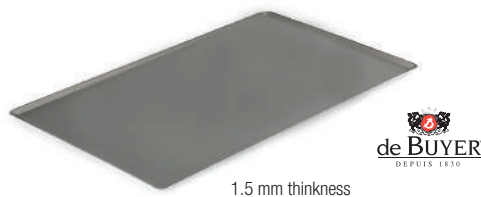

Non-Stick Aluminium Baking Tray (Oblique Edge) 不粘烤盘 (铝合金)

CODE	SIZE (l x w x h cm)	TYPE
2030753	53.0 x 32.5 x 1	1 / 1
2030765	65.0 x 53.0 x 1	2 / 1
2030740	40.0 x 30.0 x 1	40 x 30
2030760	60.0 x 40.0 x 1	60 x 40

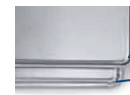

Vollrath's Wear-Ever® smooth edge corner
Competitor's crimped edge corner

American Size Aluminium Sheet Pan 铝托盘

CODE	SIZE (l x w x h cm)	SIZE (Inch)	TYPE
2021113	24 x 33 x 2.5	9.5 x 13 x 1	Quarter
2021112	45 x 33 x 2.5	13.0 x 13 x 1	Half
2021111	65 x 45 x 2.5	26.0 x 18 x 1	Full

- impact-resistant 3004 aluminium
- tapered design for easy stacking
- sized to fit standard baker's racks
- closed bead includes galvanized non-rusting rod for reinforcements
- concave bottoms flatten during heating for even heat distribution



Blue Steel Baking Tray (Oblique Edge) 铁烤盘

CODE	SIZE (l x w x h cm)	TYPE
6102053	53.0 x 32.5 x 1	1 / 1
6102065	65.0 x 53.0 x 1	2 / 1
6102040	40.0 x 30.0 x 1	40 x 30
6102060	60.0 x 40.0 x 1	60 x 40

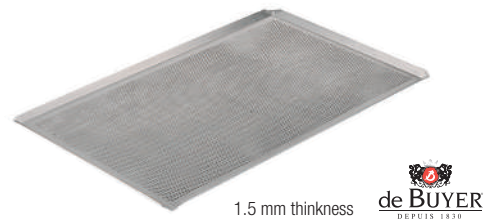

Perforated Baking Tray (Oblique Edge) 带洞烤盘

CODE	SIZE (l x w x h cm)	TYPE
2030653	53.0 x 32.5 x 1	1 / 1
2030660	60.0 x 40.0 x 1	40 x 30
2030640	40.0 x 30.0 x 1	40 x 30

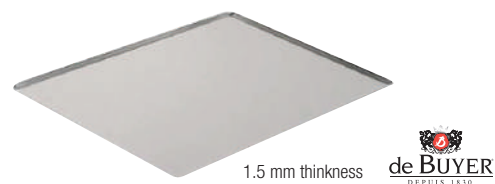

Aluminium Baking Tray (Oblique Edge) 铝烤盘

CODE	SIZE (l x w x h cm)	TYPE
2030553	53.0 x 32.5 x 1	1 / 1
2030560	60.0 x 40.0 x 1	40 x 30
2030540	40.0 x 30.0 x 1	40 x 30

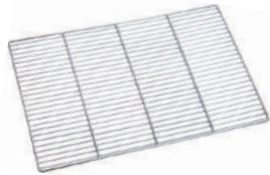

Stainless Steel Flat Grill Wire Rack
不锈钢烘烤网

CODE	SIZE (l x w cm)	FITS
2030111	53 x 32.5	1 / 1
2030121	65 x 53.0	2 / 1
2030146	60 x 40.0	40 x 60



Stainless Steel Footed Grill Wire Rack
带脚不锈钢烘烤网

CODE	SIZE (l x w cm)	FITS
2030211	53 x 32.5	1 / 1
2030221	65 x 53.0	2 / 1
2030246	60 x 40.0	40 x 60



Stainless Steel Condiment Container
不锈钢调味料盒



CODE	TYPE	SIZE (l x w x h)
2040103	3 Comp	32.0 x 15.5 x 6.3
2040104	4 Comp	41.5 x 15.5 x 6.3
2040114	4 Comp	29.3 x 21.0 x 6.3
2040105	5 Comp	51.4 x 15.5 x 6.3
2040116	6 Comp	29.3 x 31.5 x 6.3



2041002



Stainless Steel Condiment Box
不锈钢调味料盒

**GOURMET
STEEL**

CODE	TYPE	SIZE (l x w x h)	TYPE
2041001	1 Comp	13.5 x 10.5 x 5.5	
2041002	2 Comp	22.0 x 14.5 x 6.0	
2041003	3 Comp	33.0 x 14.5 x 6.0	
2041004	4 Comp	28.0 x 22.0 x 6.0	Square
2041006	6 Comp	33.0 x 28.5 x 6.0	Square

2041001



2040205



2040206



Stainless Steel Condiment Box with Hinge Lid
不锈钢翻盖调料盒

**GOURMET
STEEL**

CODE	TYPE	SIZE (l x w x h)
2040203	3 Comp	23.0 x 15.0 x 9.0
2040204	4 Comp	30.5 x 19.0 x 9.0
2040205	5 Comp	38.0 x 15.0 x 9.0
2040206	6 Comp	45.5 x 15.0 x 9.0

2040204



2040203



Plastic Condiment Dispenser

翻盖调料盒

TRAEX®

CODE	TYPE	SIZE (l x w x h)
2041104	4 Pint	30.4 x 15.0 x 11.4
2041106	6 Pint	45.7 x 15.0 x 20.6



2041104

Ice pack
2041108

11.4 x 2.8 x 13.2



2041108



2041106

Plastic Insert Condiment Box with Hinge Lid

翻盖胶内盒钢身调料盒

GOURMET
STEEL

CODE	TYPE	SIZE (l x w x h)
2040303	3 Comp	23.0 x 15.0 x 9.0
2040304	4 Comp	30.5 x 15.0 x 9.0
2040305	5 Comp	38.0 x 15.0 x 9.0
2040306	6 Comp	45.5 x 15.0 x 9.0



Stainless Steel Condiment Box

单排圆斗酱料箱

GOURMET
STEEL

CODE	SIZE (l x w x h)	TYPE
2440101	59.5 x 15 x 13.5	4 Hole
2440301	45.0 x 30 x 15.5	6 Hole



2440101

Stainless Steel Spare Condiment Container

不锈钢圆底酱料斗

CODE	SIZE (Ø x h cm)
2440201	12 x 10



2440201



2440301

Slant Stainless Steel Insert Pan Rack

不锈钢斜面味箱

CODE	SIZE (cm)	TYPE
2040413	40.5 x 34.5 x 24.0	1 / 3 x 2 Slots
2040516	51.5 x 22.5 x 22.5	1 / 6 x 3 Slots



2440413

2440516

Flat Top Stainless Steel Insert Pan Rack 不锈钢平顶味箱

CODE	TYPE	SIZE (cm)
2040616	1 / 6 x 2 Slots	35.0 x 20.5 x 16
2040716	1 / 6 x 3 Slots	51.2 x 20.5 x 16



Stainless Steel Condiment Shaker 不锈钢调味料罐



Pepper 胡椒

CODE	CAP (cc)
2050115	150
2050133	330
2050150	500



Salt 盐

CODE	CAP (cc)
2050215	150
2050233	330
2050250	500



Ajinomoto 味精

CODE	CAP (cc)
2050315	150
2050333	330
2050350	500

Stainless Steel Salt / Pepper Shaker 不锈钢盐/胡椒罐



CODE	CAP (cc)	SIZE (Ø cm)
2050430	300	7.0 x 9.4

Stainless Steel Condiment Shaker 不锈钢调味料罐



Sesame 芝麻

CODE	CAP (cc)	SIZE (Ø x h cm)
2050500	300	7.5 x 9.0
2050600	500	7.5 x 13.5

Pepper 胡椒

CODE	CAP (cc)	SIZE (Ø x h cm)
2050501	300	7.5 x 9.0
2050601	500	7.5 x 13.5

Salt 盐

CODE	CAP (cc)	SIZE (Ø x h cm)
2050502	300	7.5 x 9.0
2050602	500	7.5 x 13.5

Stainless Steel "MESH" Flour / Sugar Shaker 不锈钢密洞糖粉罐



CODE	CAP (cc)	SIZE (Ø x h cm)
2050715	150	6.0 x 8.0
2050730	300	7.0 x 9.4



PIAZZA

Stainless Steel Round Base Mixing Bowl (2 Handle) 双柄不锈钢圆底搅拌碗

CODE	SIZE (Ø x h cm)	CAP (lit)
2060120	20 x 14.0	3.5
2060125	25 x 15.0	5.0
2060130	30 x 16.0	8.0
2060135	35 x 17.5	12.0
2060140	40 x 20.5	18.0



PIAZZA

Stainless Steel Ring for Mixing Bowl 不锈钢盘架

CODE	SIZE (Ø cm)
2060200	-



Stainless Steel Round Colander with Base 不锈钢圆底滤器

PIAZZA

CODE	SIZE (Ø x h cm)	CAP (lit)
2070225	25 x 15.0	5.0
2070230	30 x 16.0	8.0
2070235	35 x 17.5	12.0
2070240	40 x 20.5	18.0

Stainless Steel X-Thick Mixing Bowl 不锈钢加厚搅拌碗

CODE	SIZE (Ø x h cm)	CODE	SIZE (Ø x h cm)
2060515	15 x 6.0	2060536	36 x 13.5
2060518	18 x 7.0	2060539	39 x 14.5
2060521	21 x 8.0	2060542	42 x 16.0
2060524	24 x 9.4	2060545	45 x 16.5
2060527	27 x 10.5	2060550	50 x 19.0
2060530	30 x 11.5	2060555	55 x 20.0
2060533	33 x 12.5	2060560	60 x 23.0



Stainless Steel Utility Mixing Bowl 不锈钢搅拌碗

CODE	SIZE (Ø x h cm)	CODE	SIZE (Ø x h cm)
2060612	12 x 7.2	2060626	26 x 10.5
2060614	14 x 8.0	2060628	28 x 11.0
2060616	16 x 8.0	2060630	30 x 11.5
2060618	18 x 8.5	2060632	32 x 12.0
2060620	20 x 9.5	2060634	34 x 12.0
2060622	22 x 9.5	2060636	36 x 12.5
2060624	24 x 9.5	2060638	38 x 13.5



Stainless Steel Round Mixing Bowl 不锈钢圆形搅拌碗

CODE	SIZE (Ø cm)	CAP (lit)	CODE	SIZE (Ø cm)	CAP (lit)
2060716	16	0.75	2060730	30	6.0
2060718	18	1.0	2060733	33	8.0
2060720	20	1.5	2060736	36	10.0
2060722	22	2.0	2060739	39	13.0
2060724	24	3.0	2060744	44	16.0
2060726	26	4.0	2060747	47	20.0
2060728	28	5.0			



Stainless Steel Mixing Bowl Complete with Stand and Wheel
不锈钢搅拌碗



CODE	CAP (qt)	SIZE (cm)
2060430	30	56.8 x 55.9 x 81.9

Stainless Steel Water Pail
不锈钢水桶



CODE	SIZE (Ø x h cm)	CAP (lit)
5132110	30 x 20 x 24	10
5132113	30 x 25 x 26	13
5132120	35 x 30 x 28	20



GOURMET
STEEL

Stainless Steel Colander
钢菜蓝

CODE	SIZE (Ø x h cm)
2070132	32 x 18
2070136	36 x 20
2070140	40 x 22
2070150	50 x 26



GOURMET
STEEL

Aluminium Round Colander
铝菜蓝

CODE	SIZE (Ø cm)
2070328	28
2070336	36
2070339	39



Stainless Steel Conical Colander
钢菜蓝

CODE	SIZE (Ø cm)
5112925	25.5
5112928	28.5
5112931	31.5



Stainless Steel Colander
钢菜蓝

CODE	SIZE (Ø cm)	CODE	SIZE (Ø cm)
2070419	19	2070430	30
2070421	21	2070433	33
2070424	24	2070436	36
2070427	27		



Stainless Steel Strainer (Wooden Handle)
木柄不锈钢油格

CODE	SIZE (Ø cm)
2080124	24
2080125	25
2080126	26
2080130	30



Stainless Steel Deep Noodle Strainer
不锈钢深面厘

CODE	SIZE (Ø cm)
2080214	14



Stainless Steel Fine Mesh Strainer
长柄不锈钢油格

CODE	SIZE (Ø cm)
2081015	15
2081020	20
2081022	22.8
2081025	25.4



Stainless Steel Strainer (Black Handle)
黑柄不锈钢油格

CODE	SIZE (Ø cm)
2080815	15
2080817	17.7
2080820	20.3
2080825	25.4



Stainless Steel Tea Strainer
不锈钢茶滤网

CODE	SIZE (Ø cm)
2080705	5.6
2080707	7.3
2080710	11



Stainless Steel Fine Mesh Strainer
不锈钢密网浅油格

CODE	SIZE (Ø cm)
2081115	15
2081117	17
2081119	19
2081120	20
2081122	22
2081125	25



Stainless Steel Tea Strainer
不锈钢茶格

CODE	SIZE (Ø cm)	CODE	SIZE (Ø cm)
2081707	7	2081714	14
2081708	8	2081718	18
2081710	10	2081722	22
2081712	12		



Stainless Steel Heavy Duty Conical Strainer
不锈钢锥形滤器



CODE	SIZE (Ø cm)
2081218	18
2081220	20
2081222	22
2081224	24
2081226	26



Stainless Steel Fine Mesh Conical Strainer with Guard
不锈钢细网锥形过滤器

CODE	SIZE (Ø cm)
2081521	21
2081524	24.5



Exoglass Conical Strainer
耐高温纤维锥形滤器



CODE	SIZE (Ø x l cm)
2081320	20 x 41

Exoglass® sieve strainer

With the same advantages of ease of use and sturdiness as the sauce strainer, these sieve strainers in composite material are designed for intensive use. Can be used to sieve ingredients, make fine stuffings and to strain sauces.



Exoglass Bowl Strainer
耐高温纤维油格



CODE	SIZE (Ø x l cm)	Mesh Size
2081720	20 x 19.5	0.7 mm

Exoglass® sieve strainer

With the same advantages of ease of use and sturdiness as the sauce strainer, these sieve strainers in composite material are designed for intensive use. Can be used to sieve ingredients, make fine stuffings and to strain sauces.



Hemmed Twist Cotton Cheese Cloth
棉芝士布



CODE	SIZE (l x w cm)	TYPE
2081600	87 x 70	Pack of 5-pcs





Stainless Steel Round Flour Sieve
不锈钢面粉筛

CODE	SIZE (Ø cm)	CODE	SIZE (Ø cm)
5112320	20	5112333	33
5112324	24	5112336	36
5112327	27	5112339	39
5112330	30	5112342	42



Round Plastic Flour Sieve
圆形塑料面粉筛



CODE	SIZE (Ø cm)	MESH SIZE
6071224	30.5	24
6071218	30.5	18
6071212	30.5	12



Stainless Steel SQ Net Wire Skimmer
不锈钢丝网撇沫勺



CODE	SIZE (Ø cm)
2090216	16
2090218	18
2090220	20
2090224	24



Stainless Steel Round Skimmer
不锈钢撇沫勺



CODE	SIZE (Ø cm)
2090108	8
2090110	10
2090112	12
2090114	14
2090116	16

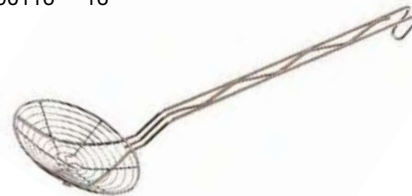

Nickel Spiral Mesh Strainer
螺旋网格过滤器

CODE	SIZE (Ø cm)	(inch)
2090315	15.0	6
2090317	17.7	7
2090320	20.0	8
2090322	22.8	9



Stainless Steel Flat Skimmer with Hook (Jumbo)
不锈钢平面油格 / 后钩



CODE	SIZE (Ø cm)
2090609	9.5
2090611	11.5





Square Reinforced Fine Mesh Strainer
方形密网过滤器

CODE	SIZE	
	(l x w cm)	(inch)
2090516	16.5 x 16.5	6.5 x 6.5



Round Reinforced Fine Mesh Strainer
圆形密网过滤器

CODE	SIZE	
	(Ø cm)	(inch)
2090416	16.5	6.5



Stainless Steel Bird Nest Fryer
油炸鸟巢网

CODE	SIZE
	(Ø cm)
2090612	12



Stainless Steel Bird Nest Fryer
不锈钢油炸鸟巢网

CODE	SIZE
	(Ø cm)
2090709	9
2090713	13
2090717	17



Round Wire Fry Basket
长柄圆炸炉网

CODE	SIZE
	(Ø cm)
2090821	21
2090824	24
2090829	29



Deep Fry Basket
不锈钢炸炉网

CODE	SIZE
	(1 x w x h cm)
2090900	20.3 x 24 x 14



Rectangular French Fry Basket
不锈钢炸炉网

CODE	SIZE
	(1 x w x h cm)
2090800	15 x 33 x 14

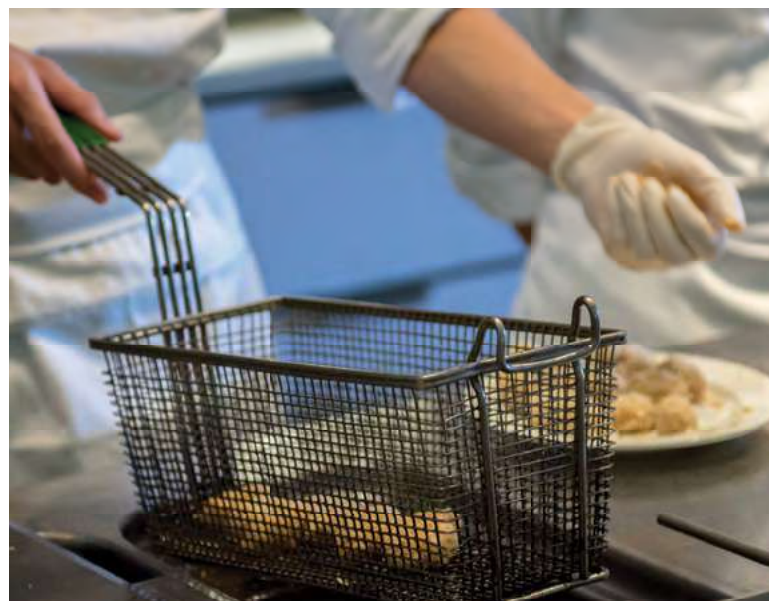

**PRIDE
DOESN'T
BEND,
BREAK,
OR FADE.**



Jacob's Pride
Lifetime Warranty
utensils are guaranteed
to last longer,
reducing waste.



**JACOB'S PRIDE
COLLECTION**

GUARANTEED FOR LIFE

All Jacob's Pride® products offer a Lifetime Warranty!



**NSF ONE-PIECE
HEAVY-DUTY
SPOODLE®**



**NSF CERTIFIED
NYLON & STAINLESS
HANDLE WHIPS**



**NSF ONE-PIECE
HEAVY DUTY
LADLES**



**NSF HEAVY-DUTY STAINLESS STEEL
BASTING SPOONS**



**NSF ONE-PIECE COLOR-CODED
KOOL-TOUCH® TONGS**

Stainless Steel Fish Lifter

不锈钢鱼铲



CODE	SIZE (l x w x h cm)	REMARK
2100400	11 x 14 x 47.5	Perforated
2100500	11 x 14 x 47.5	Solid
2100600	11 x 13 x 47.0	Slotted



Stainless Steel Fish Lifter

不锈钢鱼铲



CODE	SIZE (w x l x OL cm)
2100700	7 x 18 x 37



Stainless Steel Teppanyaki Turner

木柄不锈钢鱼铲

CODE	BLADE SIZE (cm)
2100313	9 x 10.5 x Handle 16
2100314	10 x 11.8 x Handle 18
2100315	8 x 9.0 x Handle 15



Stainless Steel Teppanyaki Turner

全/木柄钢鱼排铲

CODE	SIZE (w cm)	REMARK
2100108	8.8	Wooden Handle
2100111	11.4	Wooden Handle
2100211	11.4	Full Stainless Steel



Spatula For Frying

耐高温铲



CODE	SIZE (l x w x h cm)	REMARK
2102602		
2102601		Slotted



Exoglass Slotted Turner

耐高温铲



CODE	SIZE (l x w cm)	FIT
2102415	15 x 9	For Non-Stick Pan



Cooking Spoon

耐高温铲



CODE	SIZE (l x w x h cm)	REMARK
2102701		Spoon
2102801		Cooking Spoon



Exoglass Angled Turner

耐高温铲



CODE	SIZE (l x w cm)	FIT
2102512-03	12.5 x 8.5	For Non-Stick Pan



Long Shape Flying Fish Spatula
不锈钢鱼排铲

CODE	SIZE (w x ol cm)	REMARK
2103200	20 x 31	



Turner
不锈钢铲

CODE	BLADE SIZE (w x l cm)	REMARK
2103400	10 x 16	



Curved Spatula
胶柄锅铲



CODE	BLADE SIZE (w x l cm)	REMARK
2102913	5 x 12.5	Slotted
2103013	5 x 12.5	Solid



Angled Burger Spatula
胶柄直角汉堡锅铲



CODE	BLADE SIZE (w x l cm)	REMARK
6070713	5.5 x 13	



Curved Spatula
胶柄锅铲



CODE	BLADE SIZE (w x l cm)	REMARK
2130913	5 x 12.5	



Angled Turner
胶柄锅铲



CODE	BLADE SIZE (w x l cm)	REMARK
2102913	8 x 13.5	



Angled / Cranked Spatula / Turner
胶柄不锈钢铲



CODE	SIZE (w x l cm)	REMARK
2103300	6.5 x 9.3	Solid
2103201	10	Perforated



STRAIGHT SPATULA
胶柄直锅铲



CODE	SIZE (w x l cm)	REMARK
6070213	10 x 12.8	

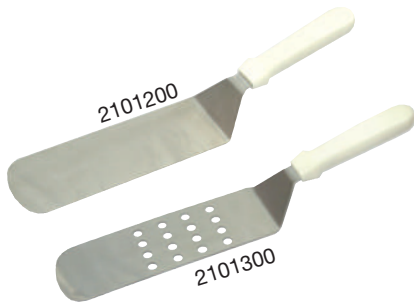

Stainless Steel Offset Turner
胶柄不锈钢/有孔铲

CODE	SIZE (l x w x h cm)	REMARK
2101200	25.4 x 7 x 38	Solid
2101300	25.4 x 7 x 38	Perforated



Stainless Steel Burger Turner
长木柄不锈钢汉堡铲

CODE	SIZE (l x w cm)
2101800	25.4 x 7



Stainless Steel Grill / Pan Scraper
木柄不锈钢烤盘铲

CODE	SIZE (l x w x h cm)
2102200	11.4 x 5.7 x 19



Stainless Steel Scraper
黑胶柄不锈钢平铲

CODE	SIZE (w cm)	(Inch)
2102002	2.5	1.0
2102003	3.8	1.5
2102005	5.0	2.0
2102006	6.35	2.5
2102007	7.6	3.0
2102010	10	4.0
2102012	12.7	5.0
2102015	15	6.0
2102020	20	7.8



Stainless Steel Angled Burger Turner
木柄不锈钢汉堡铲

CODE	SIZE (l x w cm)	
2101400	15.0 x 7.6	
2101500	12.7 x 7.6	
2101600	25.4 x 7.0	Solid
2101700	25.4 x 7.0	Perforated
2101900	25.4 x 10	



Stainless Steel Tepanyaki Scraper
(Wooden Handle)
木柄不锈钢铁板烧铲

CODE	SIZE (l x w cm)
2102107	13 x 7.3
2102109	13 x 8.8
2102110	13 x 9.7



Stainless Steel Scraper
木柄不锈钢斜面漆铲

CODE	SIZE (w cm)
2102310	10



Straight Flexible Blade Spatula
(Black Handle)
胶柄直刮刀



CODE	SIZE (l cm)	CODE	SIZE (l cm)
6070315	15	6070327	27
6070318	18	6070330	30
6070320	20	6070335	35
6070323	23		



Serrated + Straight Blade Spatula
齿形刮刀



CODE	SIZE (cm)
6070530	30
6070535	35



Stainless Steel Icing Spatula
(Plastic Handle)
胶柄刮刀

CODE	SIZE (l cm)	CODE	SIZE (l cm)
2130215	15.0	2130230	30.4
2130220	20.0	2130235	35.5
2130225	25.4		



Stainless Steel Offset Spatula
(Black Handle)
胶柄刮刀

CODE	SIZE (l cm)	CODE	SIZE (l cm)
2130415	15.0	2130430	30.4
2130420	20.0	2130435	35.5
2130425	25.4		



Spreader Spatula
刮刀



CODE	SIZE (cm)
2130909	9



Small Spatula
小刮刀



CODE	SIZE (cm)	
2130810	10	Straight
2103110	10	Curved



Curved Spatula Flexible with Black Handle
胶柄曲刮刀



CODE	SIZE (l cm)
6070415	15
6070421	21
6070427	27



Stainless Steel Icing Spatula
(Wooden Handle)
木柄刮刀

CODE	SIZE (l cm)	CODE	SIZE (l cm)
2130115	15.0	2130130	30.4
2130120	20.0	2130135	35.5
2130125	25.4		



Stainless Steel Offset Spatula
(Wooden Handle)
木柄刮刀

CODE	SIZE (l cm)	CODE	SIZE (l cm)
2130315	15.0	2130330	30.4
2130320	20.0	2130335	35.5
2130325	25.4		



High Heat Flat Shape Plastic Spatula
耐高温胶刮刀

CODE	SIZE	
	(l cm)	(inch)
2120910	24.0	10
2120914	35.5	14
2120916	40.6	16



High Heat Spoon Shape Plastic Spatula
耐高温胶刮刀

CODE	SIZE	
	(l cm)	(inch)
2121010	24.0	10
2121014	35.5	14
2121016	40.6	16



up to
200°C

High Heat Silicon Spatula
(Wooden Handle)
耐高温刮刀



CODE	SIZE
	(l x w cm)
2120110	26.2 x 5.5
2120113	34.6 x 7.0
2120116	42.2 x 7.0



up to
315°C

Nylon Spatula / Scraper
胶刮刀

CODE	SIZE	
	(l cm)	(inch)
2120224	24.0	10
2120233	33.0	13
2120240	40.6	16



"EXOGLASS" Spatula
耐高温纤维刮刀



CODE	SIZE	CODE	SIZE
	(l cm)		(l cm)
2120325	25	2120340	40
2120330	30	2120350	50
2120335	35		



Narrow Blade Plastic Spatula
胶刮刀

CODE	SIZE	
	(l cm)	(inch)
2120710	24.0	10
2120714	35.5	14
2120716	40.6	16



Flat Shape Plastic Spatula
胶刮刀

CODE	SIZE	
	(l cm)	(inch)
2120610	24.0	10
2120614	35.5	14
2120616	40.6	16



Spoon Shape Plastic Spatula
胶刮刀

CODE	SIZE	
	(l cm)	(inch)
2120810	24.0	10
2120814	35.5	14
2120816	40.6	16



Wooden Spoon (Long Handle)
长柄木勺

CODE	SIZE	CODE	SIZE
	(l cm)		(l cm)
2120510	25	2120518	45
2120512	30	2120520	50
2120514	35	2120532	80
2120516	40	2120539	100



up to
204°C



High Heat Nylon Kitchen Spoon
耐高温尼龙勺

CODE	SIZE	
	(l cm)	(inch)
2120412	30.5	12
2120415	38.0	15



Stainless Steel Mixing Paddle / Oar
不锈钢搅拌桨

CODE	SIZE (l cm)	CODE	SIZE (l cm)
2140124	60.90 x 6.35	2140154	137.00 x 6.35
2140142	106.68 x 6.35	2140160	152.40 x 6.35
2140148	121.90 x 6.35		



Wooden Oar / Stirrer
木打饭匙

CODE	SIZE (l cm)	CODE	SIZE (l cm)
2140218	45.7	2140248	121.9
2140224	60.9	2140260	152.4
2140230	76.2	2140272	182.8
2140236	91.4		



Bamboo Turner (Curve Head)
竹铲 (弯头)

CODE	SIZE (l x w cm)	TYPE
2140388	30 x 7	Curve
2140384	30 x 7	Flat



Bamboo Rice Scoop
竹饭匙

CODE	SIZE (l x w cm)
2140382	23 x 7.5



Plastic Rice Scoop
胶饭匙

CODE	SIZE (l cm)
2140422	22.5



Stainless Steel Professional Soup Ladle
不锈钢汤勺

PIAZZA

CODE	SIZE (l x w cm)	CAP (lit)
2110106	6 x 31	0.06
2110107	7 x 34	0.08
2110108	8 x 36	0.125
2110109	9 x 36	0.19
2110110	10 x 43	0.25
2110112	12 x 52	0.50
2110114	14 x 55	0.75
2110116	16 x 61	1.0
2110118	18 x 64	1.5
2110120	20 x 72	2.0



Stainless Steel Ladle with Hook
不锈钢汤勺/后钩



CODE	SIZE (l x w cm)	CAP (cc)
2110401	25.0 x 3.5	10
2110402	25.0 x 4.5	20
2110403	25.0 x 5.0	30
2110404	25.0 x 5.5	36
2110409	25.0 x 7.7	90
2110414	26.0 x 8.5	145
2110418	27.0 x 9.5	180
2110427	31.0 x 10.5	270
2110436	31.0 x 11	360
2110454	32.0 x 13	540
2110411	38.5 x 15.5	1000
2110418	48.0 x 19.5	1800



Economy Soup Ladle with Hook
不锈钢汤勺

CODE	CAP	CODE	CAP (oz)
2110200	0.5	2110204	4
2110201	1	2110206	6
2110202	2	2110208	8
2110203	3		



Setting the Standard™



One-Piece Heavy-Duty Spoodle® Utensil

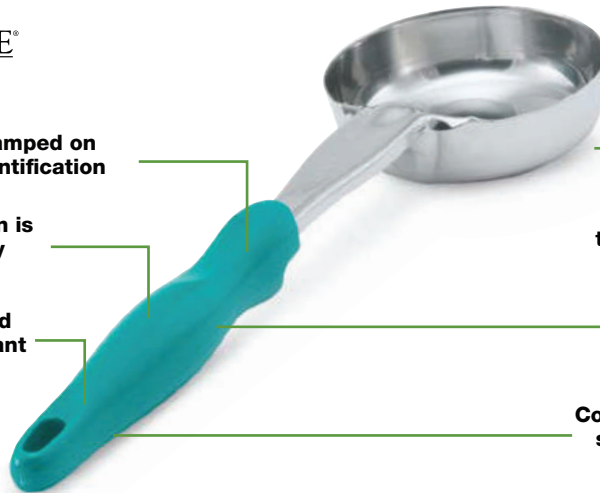

Capacities clearly stamped on shaft for easy size identification

One-piece construction is durable and sanitary

High temperature patented nylon handle – heat resistant to 450°F (232°C)

Mirror-finished stainless steel shafts and bowls – Unique oval bowl design fits into resistant to corrosion corners of Super Pan 3® steam table pans – reducing waste and maximizing serving efficiency

Textured surface prevents slippage while in use

Color-coded for quick size identification

Built-in stopper notch prevents Spoodle from sliding into food product



Oval Spoodle



Ergonomic design offers comfort and reduces hand fatigue



One-Piece Round Spoodle® Utensil



One-Piece Round Spoodle Utensil 胶柄餐勺



CODE	SIZE (ø l x w x h cm)	CAP (oz)	REMARKS
2111802	ø 6.5	2	Solid
2111804	ø 8.2	4	Solid
2111806	ø 9.3	6	Solid
2111808	ø 10.2	8	Solid
2111902	ø 6.5	2	Perforated
2111904	ø 8.2	4	Perforated
2111906	ø 9.3	6	Perforated
2111908	ø 10.2	8	Perforated

One-Piece Oval Spoodle Utensil 胶柄餐勺



CODE	SIZE (l x w x h cm)	CAP (oz)	REMARKS
2112002	7.5 x 6.8	2	Solid
2112004	9.4 x 8.6	4	Solid
2112006	10.7 x 9.8	6	Solid
2112008	11.8 x 10.7	8	Solid
2112102	7.5 x 6.8	2	Perforated
2112104	9.4 x 8.6	4	Perforated
2112106	10.7 x 9.8	6	Perforated
2112108	11.8 x 10.7	8	Perforated



Setting the Standard™



One-Piece Heavy-Duty Ladles

- One-piece construction for easy cleaning
- Accurate bowl dimensions insure consistent capacities

CODE	SIZE (l x w cm)	CAP (oz)
2112401	Ø 4.4	1
2112402	Ø 6.0	2
2112403	Ø 7.3	3
2112404	Ø 8.6	4
2112406	Ø 8.9	6
2112408	Ø 10.2	8

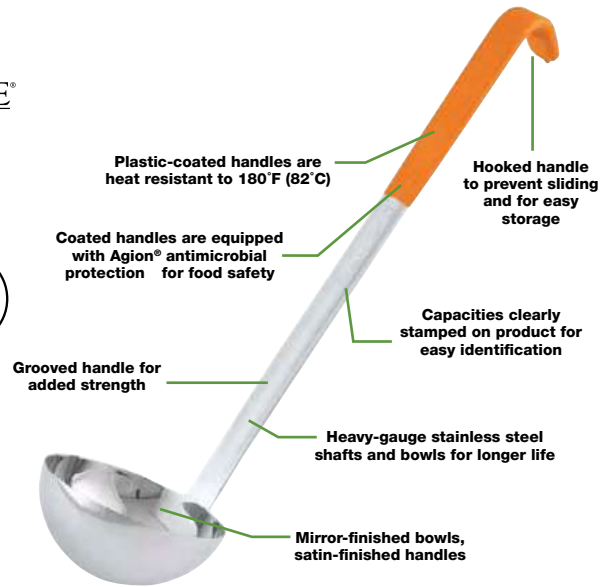

Heavy-Duty Stainless Steel Basting Spoons with Ergo Grip® Handles

- Heavy-gauge stainless steel shaft and bowls — resistant to corrosion
- One-piece construction is extremely durable and has no crevices to collect water or bacteria
- 3-sided spoon has one straight edge for cutting to aid in serving solid, sticky, or cheesy food products



CODE	SIZE (l cm)	REMARKS
2112235-xx	35.1	Solid
2112335-xx	35.1	Perforated

RD GR BL YE

When ordering white Spade add CODE suffix to item number (example: 2211025-WH)



Stainless Steel Deep Serving Spoon
长柄调羹

PIAZZA

CODE	SIZE (l x w x h cm)
2111200	11 x 7 x 40.5



Stainless Steel Deep Side Serving Spoon
长柄调羹

PIAZZA

CODE	SIZE (l x w x h cm)
2111300	11 x 7 x 37



Stainless Steel Meat Serving Fork with Hook
长柄叉

PIAZZA

CODE	SIZE (l cm)
2111442	42



Stainless Steel Cooking Fork with Hook
不锈钢牛肉叉



CODE	SIZE (l cm)
2111529	29



Stainless Steel Horizontal Oval Ladle with Hook
不锈钢侧椭圆头分餐勺



CODE	SIZE (l cm)
2110627	27.5



Stainless Steel Oval Serving Ladle with Hook
不锈钢椭圆头分餐勺



CODE	SIZE (l cm)
2110527	27.5



Stainless Steel Horizontal Oval Gravy Ladle with Hook (Perforated)
不锈钢侧椭圆头有洞分餐勺



CODE	SIZE (l cm)
2110727	27.5

Stainless Steel Oval Serving Spoon

(Black Handle)

黑柄椭圆头不锈钢勺



Solid

CODE	SIZE (l cm)	(Inch)
2110827	27.9	11
2110833	33.0	13
2110838	38.0	15

Perforated

CODE	SIZE (l cm)	(Inch)
2110928	27.9	11
2110933	33.0	13
2110938	38.0	15

Slotted

CODE	SIZE (l cm)	(Inch)
2111028	27.9	11
2111033	33.0	13
2111038	38.0	15

1 Pcs Oval Serving Spoon

(Black Handle)

条洞黑柄椭圆头不锈钢勺



Solid

CODE	SIZE (l cm)	(inch)
2111128	27.9	11
2111133	33.0	13
2111138	38.0	15

Perforated

CODE	SIZE (l cm)	(inch)
2111028	27.9	11
2111033	33.0	13
2111038	38.0	15





Setting the Standard™



NSF Certified Nylon Handle Whisk

Vollrath introduces a unique patent-pending ergonomic whip with NSF certification. The one-piece handle is completely sealed with no crevices to collect food or bacteria. Vollrath backs up the durability of these whips with their Limited Lifetime Warranty.

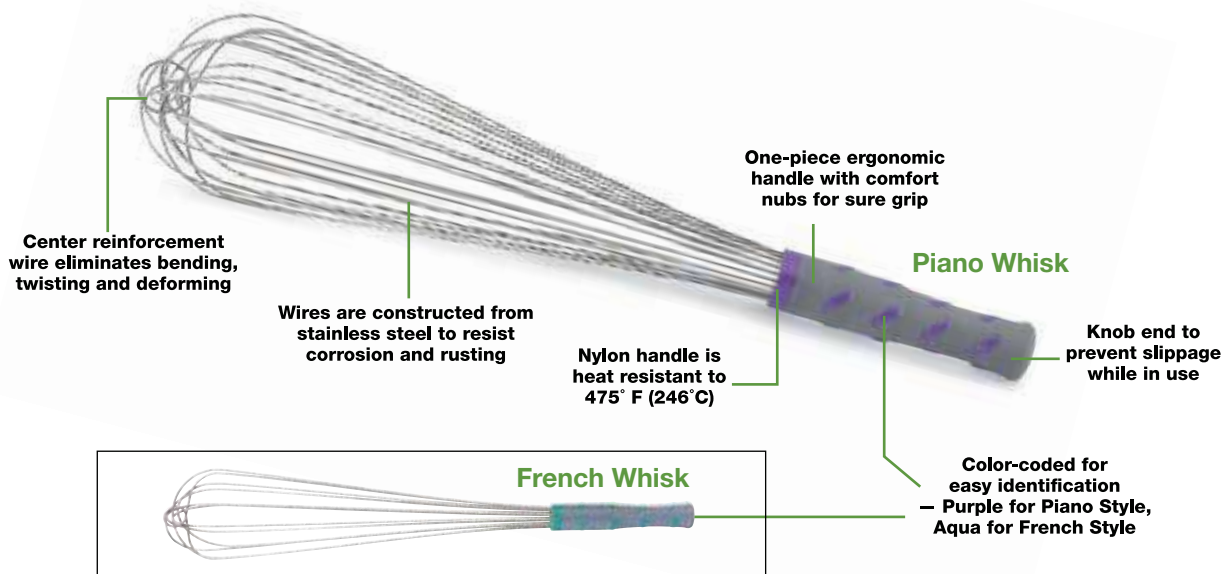

Stainless Steel Piano Whisk with Nylon Handle 轻巧试尼龙打蛋器

CODE	SIZE	
	(l cm)	(inch)
2150510	26	10
2150512	31	12
2150514	36	14
2150516	41	16
2150518	46	18



Stainless Steel French Whisk with Nylon Handle 法式试尼龙打蛋器

CODE	SIZE	
	(l cm)	(inch)
2150610	25	10
2150612	30	12
2150614	35	14
2150616	40	16
2150618	45	18
2150620	50	20
2150622	56	22
2150624	61	24

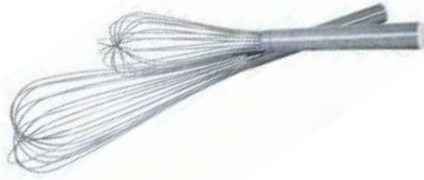

Stainless Steel Heavy Duty Egg Whisk
不锈钢打蛋器

CODE	SIZE		SAINT ROMAIN
	(l cm)	(inch)	
2150120	20	7.8	
2150125	25	9.8	
2150130	30	11.8	
2150135	35	13.8	
2150140	40	15.7	
2150145	45	17.7	
2150150	50	19.6	



Stainless Steel Heavy Duty Egg Whisk with Composite Handle
不锈钢打蛋器

CODE	SIZE		SAINT ROMAIN
	(l cm)	(inch)	
2150325	25	7.8	
2150330	30	11.8	
2150335	35	13.8	
2150340	40	15.7	
2150345	45	17.7	



Exoglass Handle Egg White Balloon Whisk
不锈钢打蛋器



CODE	SIZE	
	(l cm)	(inch)
2151200	45	17.7"



Stainless Steel Kettle Whisk
长柄不锈钢打蛋器

CODE	SIZE	
	(l cm)	(inch)
2151048	121.9	48
2151068	172.7	68



Stainless Steel Heavy Duty Egg Whisk with Hook
不锈钢打蛋器

CODE	SIZE		SAINT ROMAIN
	(l cm)	(inch)	
2150225	25	7.8	
2150230	30	11.8	
2150235	35	13.8	
2150240	40	15.7	
2150245	45	17.7	
2150250	50	19.6	



Stainless Steel Heavy Duty Egg Whisk with Composite Handle
不锈钢打蛋器

CODE	SIZE	
	(l cm)	(inch)
2150425-xx	25	7.8
2150430-xx	30	11.8
2150435-xx	35	13.8
2150440-xx	40	15.7
2150445-xx	45	17.7

*Available Color

BL GR RD YE

When ordering blue Tong add **CODE** suffix to item number
(example: 2150425-BL)



Stainless Steel Egg Whisk
不锈钢打蛋器



CODE	SIZE
	(l cm)
2150712	30.4
2150714	35.5

KITCHENWARE

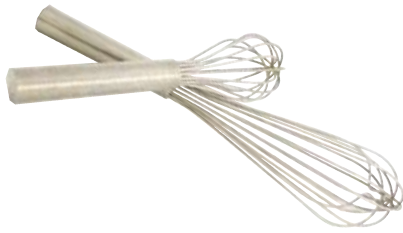

Economy Stainless Steel French Egg Whisk
经济型不锈钢法式打蛋器

CODE	SIZE	
	(l cm)	(inch)
2151110	25.4	10
2151112	30.4	12
2151114	35.5	14
2151116	40.6	16
2151118	45.7	18
2151120	50.8	20
2151122	55.9	22
2151124	60.9	24

GOURMET STEEL



Polycarbonate Measuring Cup
量杯 **CAMBRO**

CODE	CAP (lit)	CODE	CAP (lit)
2160102	0.25	2160120	2.0
2160105	0.5	2160140	4.0
2160110	1.0		



Polycarbonate Measuring Cup
胶量杯 

CODE	SIZE (cm)	CAP (lit)	CODE	SIZE (cm)	CAP (lit)
2161002	7.1	0.2	2161020	14.8	2.0
2161005	8.7	0.5	2161030	17.2	3.0
2161010	11.3	1.0			



Stainless Steel Measuring Cup
不锈钢量杯 

CODE	SIZE (cm)	CAP (lit)	CODE	SIZE (cm)	CAP (lit)
2160304	8	0.4	2160332	16	3.2
2160307	10	0.7	2160345	18	4.5
2160313	12	1.3	2160362	20	6.2
2160321	14	2.1			

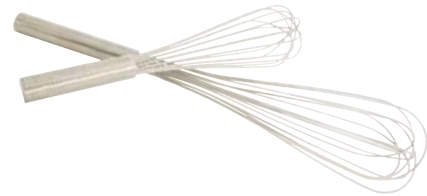

Economy Stainless Steel Piano Egg Whisk
经济型不锈钢轻巧试打蛋器

CODE	SIZE	
	(l cm)	(inch)
2150808	19.0	7.5
2150810	25.4	10
2150812	30.4	12
2150814	35.5	14
2150816	40.6	16
2150818	45.8	18

GOURMET STEEL



Plastic White Measuring Cup
胶量杯

CODE	CAP (lit)	CODE	CAP (lit)
2160205	0.5	2160220	2.0
2160210	1.0	2160235	3.0
		2160250	5.0



Stainless Steel Measuring Jug
不锈钢量杯 

CODE	SIZE (l x w cm)	CAP (lit)
2160405	10 x 10.5	0.5
2160410	13 x 13.0	1.0
2160415	14 x 15.0	1.5
2160420	16 x 18.5	2.0



Stainless Steel Measuring Cup
不锈钢量杯

CODE	CAP (lit)
2160505	0.5
2160510	1
2160520	2
2160530	3

GOURMET STEEL



Stainless Steel Measuring Cup Set
不锈钢量杯

CODE	SIZE
2160700	¼ / ⅓ / ½ / 1 Cup



Stainless Steel Measuring Spoon Set
不锈钢量匙

CODE	SIZE
2160800	1.25 / 2.5 / 5 / 15 ml or ¼ / ½ / 1 Teaspoon / 1 Tablespoon



Polycarbonate Ice Scoop
胶冰铲

CAMBRO

CODE	CAP (oz)
2170106	6
2170112	12
2170124	24
2170164	64



Cast Aluminium Ice Scoop
铝制冰铲

CODE	CAP (oz)
2170205	5
2170212	12
2170224	24
2170238	38
2170258	58
2170285	85



Stainless Steel Heavy Duty Ice Scoop
不锈钢冰铲

CODE	CAP (oz)
2170306	6
2170312	12
2170324	24
2170336	36



Stainless Steel Round Flour / Ice Scoop
不锈钢圆底冰铲

CODE	SIZE (l cm)
2170416	16
2170421	21



Insta Chill® Food Cooler
冰容器

TRAEX®

CODE	SIZE (ø x h cm)	CAP (lit)
2170802	39.3 x 10	2
2170804	59.6 x 10	4



Ice Scoop Kit
冰铲(套)

TRAEX®

CODE	CAP (oz)
2170932	32
2170964	64

Stainless Steel Scoop (Long Handle) Handle

长木柄不锈钢勺



CODE	SIZE (l cm)	CAP (lit)
2170613	13.5	0.65
2170614	14.5	1.0
2170616	16.0	1.35



Stainless Steel Oil Funnel with Drainer 钢有过滤网油漏斗桶

CODE	THICKNESS (mm)
6020804	10.0



Stainless Steel Oil Funnel (Wide Opening) 不锈钢油漏斗 (宽口)

CODE	SIZE (Ø cm)
2180324	24



Stainless Steel Automatic Piston Funnel & Stand 不锈钢自动漏斗器

Funnel

CODE	SIZE (Ø cm)	CAP (lit)
2200319	19.0	1.9
2200415	17.5	1.5

Stand

2200215	15
---------	----



Stainless Steel Oil Funnel (Small Spout) 不锈钢油漏斗 (细口)

CODE	SIZE (Ø cm)
------	----------------

2180213	13.3
2180216	16.0
2180218	18.0
2180220	20.0



Stainless Steel Automatic Piston Funnel + Stand 不锈钢自动漏斗器+架

CODE	SIZE (l x w x h cm)	CAP (lit)
2200108	15.5 x 18.5 x 15	0.8



Stainless Steel Automatic Piston Funnel & Stand 不锈钢自动漏斗器

CODE	SIZE (Ø cm)	CAP (lit)
2200533	20	3.3





LIGHT&STRONG

Material

The Innovative Composition Of Nylon And Fiberglass Matches Stiffness, Great Mechanical Strength And Extraordinary Lightness. It Stands Temperatures From -30°C To +170°C, Is Dishwasher Safe And Fully Complies With Eec And Fda Standards.

Rack

The Perfectly Adjusted Mechanism Provides Excellent Sliding With Minimum Pressure Effort, Then Cutting Down Fatigue And Tiredness.

Strip

Made Of Stainless Steel, It Provides The Best Cut Of Ice-cream And, Together With The Polished Cup, Always Results In Perfect Shape Scoops.

Rod And Spring

They Are Also Made Of Stainless Steel And Their Operation Is Unparalleled; They Are Very Strong, Have A Long Life And Their Operation Undergoes No Change.

Central Hub

Careful Check On Allowances, First During The Molding And Then The Assembly Stage, Guarantees, Together With Compact Design, Top Hygiene Of The Scoop Because There Are No Areas Where Residues Of Dirt Can Settle.

Handle

Perfectly Ergonomic And, With Its Special Matte Surface, It Is Fully Anti-slip For A Strong And Safe Grip At All Times.



Pastic Ice-cream scoop (coloured steel bar) 雪糕勺

CODE	SIZE (Ø cm)	TYPE	CAP (oz)
2211424-xx	5.5	1/24	1.38
2211430-xx	5.2	1/30	1.10
2211436-xx	4.9	1/36	0.92
2211440-xx	4.7	1/40	0.83

*Available Color

WH YE RD GR BL OR

When ordering white scoop add **CODE** suffix to item number (example: 2211430-WH)



Stainless Steel Ice Cream Scoop 圓形不銹鋼雪糕勺

CODE	SIZE (Ø cm)	TYPE	CAP (oz)
2210708	7.8	8	4.13
2210710	7.5	10	3.30
2210712	7.0	12	2.75
2210716	6.3	16	2.06
2210720	6.0	20	1.65
2210724	5.5	24	1.38
2210730	5.2	30	1.10
2210736	4.9	36	0.92
2210740	4.7	40	0.83
2210750	4.3	50	0.66
2210760	4.0	60	0.55
2210770	3.7	70	0.47
2210711	3.0	100	0.33



Oval Stainless Steel Ice Cream Scoop 橢圓形不銹鋼雪糕勺



CODE	SIZE (Ø cm)	TYPE	CAP (oz)
2210520	7.0 x 5.2	20	1.65
2210530	6.2 x 4.3	30	1.10
2210540	5.7 x 3.8	40	0.83

Round Stainless Steel Ice Cream Scoop

圓形不銹鋼雪糕勺



CODE	SIZE (Ø cm)	TYPE	CAP (oz)	CODE	SIZE (Ø cm)	TYPE	CAP (oz)
2210604	10	4	8.25	2210630	4.9	30	1.10
2210605	9.0	5	6.60	2210636	4.7	36	0.92
2210606	8.2	6	5.50	2210640	4.5	40	0.83
2210607	8.1	7	4.71	2210645	4.4	45	0.73
2210608	8.0	8	4.13	2210650	4.3	50	0.66
2210610	7.0	10	3.30	2210655	4.1	55	0.60
2210612	6.7	12	2.75	2210660	4.0	60	0.55
2210616	5.9	16	2.06	2210665	3.8	65	0.51
2210620	5.6	20	1.65	2210670	3.5	70	0.47
2210622	5.3	22	1.50	2210685	3.3	85	0.39
2210624	5.1	24	1.38	2210611	3.0	100	0.33





Aluminium Ice Cream Scoop
雪糕勺



CODE	TYPE	CAP (oz)
2210230	30	1.0
2210224	24	1.5
2210220	20	2.0
2210216	16	2.5
2210212	12	3.0
2210210	10	4.0



Dipper Aluminium Ice Cream Scoop
不锈钢水桶



CODE	SIZE (Ø cm)	TYPE	CAP (oz)
2210312	6.7	12	2.75
2210316	5.9	16	2.06
2210320	5.6	20	1.65
2210324	5.1	24	1.38
2210330	4.9	30	1.10
2210340	4.5	40	0.83



**"CERAMIC COATED" Dipper
Aluminium Ice Cream Scoop**
雪糕勺



CODE	SIZE (Ø cm)	TYPE	CAP (oz)
2210416	5.9	16	2.06
2210420	5.6	20	1.65
2210424	5.1	24	1.38
2210430	4.9	30	1.10



Portion Scoop "CUPE"
方形不锈钢雪糕勺



CODE	SIZE (Ø cm)	TYPE	CAP (oz)
2210820	3.7 x 3.7 x 3.7	20	1.65
2210830	3.2 x 3.2 x 3.2	30	1.10



Portion Scoop "HEART SHAPE"
心形不锈钢雪糕勺



CODE	TYPE	CAP (oz)
2210825	25	1.32



**Stainless Steel Ice Cream Scoop
with Blue Plastic Handle**
圆形不锈钢雪糕勺



CODE	SIZE (l cm)	CAP (oz)
2210916	5.9	2.06
2210920	5.6	1.65
2210924	5.1	1.38
2210930	4.9	1.10
2210960	4.0	0.55
2210911	3.0	0.33



Original Zeroll Spade
雪糕铲

ZEROLL

CODE

2211100



Aluminium Ice Cream Spade
雪糕铲

stöckel

CODE	SIZE (Ø cm)	TYPE	CAP (oz)
------	----------------	------	-------------

2211200 22



**Stainless Steel Gelato
Ice Cream Spade**
彩色胶柄雪糕勺

PIAZZA

CODE	SIZE (l cm)
------	----------------

2211025-xx 25

*Available Color

WH BK RD GR

When ordering white Spade add **CODE** suffix to item number (example: 2211025-WH)



**Stainless Steel Ice Cream Scoop
Wash Basin**
雪糕铲盆

PIAZZA

CODE	SIZE (l cm)
------	----------------

2211300 27 x 11 x 12



Stainless Steel Cooking Tweezer
不锈钢夹

triangle®



Straight

CODE	SIZE (l cm)
------	----------------

2222830 30



Curve

CODE	SIZE (l cm)
------	----------------

2222915 15



Curve

CODE	SIZE (l cm)
------	----------------

2222935 35



Precision Kitchen Tong / Pincer
不锈钢夹

CODE	SIZE (l cm)
2222330	30
2212323	23
2222315	16



40deg Angled Precision Kitchen Pincer / Tweezer
不锈钢夹

CODE	SIZE (l cm)
2222430	30.0
2222423	23.5
2222415	15.0



Precision "KAIMAN" Fish Bone Pincer / Tweezer
不锈钢夹

CODE	SIZE (l cm)
2222518	18



Alma Tasting Spoon
不锈钢多功能匙

CODE	SIZE (l cm)
2222616	13.5

The Alma Kaiman tongs are added to the popular Alma Test tongs, extending the wide range of PIAZZA kitchen tongs. The original idea by Luciano Tona has been turned into reality thanks to the design by Michele Capuani. Specifically conceived for fish.

- PRECISION FISH BONE REMOVERS
- REAR NOTCHES FOR PERFECT FISH SCALING
- NON-SLIP RIDGES FOR A SECURE GRIP



A new tool measuring just 13.5 cm that's bound to become indispensable for all catering professionals as it offers so many different functions:

- SPOON FOR TASTING FOOD
- TONGS FOR ASSEMBLING PREPARATIONS WITH SURGICAL PRECISION
- SCALED MEASURE (0.5 CM)



Pastry Scissor Tong
不锈钢蛋糕夹

CODE	SIZE (l cm)
2220118	18.5



Pastry Scissor Tong
不锈钢蛋糕夹

CODE	SIZE (l cm)
2220220	20

Universal Scallop Tong
不锈钢扇贝形万能夹

CODE	SIZE (l cm)
2222118	18.0
2222112	12.0
2222123	23.5
2222130	30.0



PIAZZA's tongs have always been the collection used as reference point for the market, both for design and for the effective superiority of a product that is a must for every professional's collection. Lastly, the details highlight the uniqueness of each individual pair: the curvature of certain applications, such as the spaghetti tongs, which is like an invitation to gather up the food in the best way; or the spring which always gives the same manoeuvrability even after an infinite number of pressing, this thanks to an exclusive production device which is still secret today, as are the formulas which for years have resisted all attempts of imitation. Precisely this certainty permits Piazza alone to guarantee the inalterability of its tongs.



Flat Curved Universal Tong
不锈钢万能夹

CODE	SIZE (l cm)
2222218	18
2222223	23
2222230	30



Fork & Spoon Serving Tong
不锈钢服务夹

CODE	SIZE (l cm)
2220323	23



Flat Front Serving Tong
不锈钢面包夹

CODE	SIZE (l cm)
2220423	23



Bright Serving Tong
不锈钢服务夹

CODE	SIZE (l cm)
2221119	19.5



Spaghetti Tong
不锈钢面夹

CODE	SIZE (l cm)
2220630	30



Spaghetti Tong
不锈钢面夹

CODE	SIZE (l cm)
2220523	23.5



Vegetable Tong
不锈钢蔬菜夹

CODE	SIZE (l cm)
2221019	19.5



Salad Tong
不锈钢沙拉夹

CODE	SIZE (l cm)
2221719	19.5



"MOLLUNGA" Buffet Tong
 不锈钢自助餐夹

CODE	SIZE (l cm)
2220730	30



Bread Tong
 不锈钢面包夹 (有洞)

CODE	SIZE (l cm)
2220916	16.5



Toast Tong
 不锈钢面包夹 (有洞)

CODE	SIZE (l cm)
2221221	21



Buffet Toast Tong
 不锈钢自助餐点心夹

CODE	SIZE (l cm)
2220830	30



Pastry Tong
 不锈钢蛋糕夹

CODE	SIZE (l cm)
2221518	18



Sugar Tong
 不锈钢糖果夹

CODE	SIZE (l cm)
2221412	12.5



Molla Ice Cube Tong
 不锈钢冰块夹

CODE	SIZE (l cm)
2221318	18



Stainless Steel BBQ Tong 不锈钢烧烤夹

PIAZA

CODE	SIZE (l cm)
2221850	50



Polycarbonate Scallop Grip Surface Tong 扇边夹

CAMBRO

CODE	SIZE	
	(l cm)	(inch)
2230106-xx	15.0	6
2230109-xx	22.8	9
2230112-xx	30.5	12

Lugano Flat and Scallop Grip Tongs

- Easily grasp hard to hold items such as salad greens and tomatoes
- Scallop Tongs feature an ergonomic design and secure finger grip
- Flat Tongs are ribbed to provide a secure hold

*Available Color

■ BK ■ RD ■ BE □ WH

When ordering black Tong add **CODE** suffix to item number (example: 2230106-BK)



Polycarbonate Flat Grip Surface Tong 扇边夹

CAMBRO

CODE	SIZE	
	(l cm)	(inch)
2230206-xx	15.0	6
2230209-xx	22.8	9

*Available Color

■ BK □ WH □ CL ■ RD ■ BE

When ordering black Tong add **CODE** suffix to item number (example: 2230206-BK)



"COMB" Angled Tong 斜角面夹

CAMBRO

CODE	SIZE	
	(l cm)	(inch)
2230326	26	10
2230321	21	9

Lugano Angled and Easy-Grasp Tongs

- Angled tongs feature an ergonomic design that makes it easy to serve a variety of foodst
- Easy-Grasp Tongs combine a fork and spoon, providing a secure grip for hard to hold items.



High Temperature Nylon End One-Piece Tongs

- High-temperature nylon is heat resistant up to 450°F (232°C)
- Nylon end will not scratch or mar non-stick surfaces
- Coated handle is equipped with Agion antimicrobial protection
- Ergonomic design is comfortable to use and reduces hand fatigue
- One-piece body construction with over-molded end is sanitary and will not come apart
- Concave scalloped utility end gently grips food product
- Heavy-gauge stainless steel body is resistant to corrosion and rusting
- No spring design is safe and sanitary
- Optional black plastisol-coated handle provides cool, comfortable grip and is heat resistant up to 180°F (82°C)
- Dishwasher safe



Setting the Standard™



JACOB'S PRIDE®
COLLECTION
GUARANTEED FOR LIFE

High Temperature Utility Tong with Nylon End & Coated Handle 耐高温尼龙头夹



CODE	SIZE	
	(l cm)	(inch)
2250424	24.0	9
2250430	30.5	12
2250440	40.6	16

Multi-Pack Color-Coded NSF Utility Tong

Vollrath's 9 1/2" (24.1 cm) scalloped utility-style color-coded tongs
Multi-Pack includes 6 color-coded tongs — one each of black, blue, red, yellow, tan and green



Multi-Pack Color-Coded Scallop Tong (Pack of 6) 6 套装彩色夹

CODE	SIZE	
	(l cm)	(inch)
2250224	24	9

Heavy-Duty One-Piece Tongs



- Special stainless steel for enhanced performance
- Unique springless design eliminates bacteria-prone food traps

Heavy Duty Stainless Steel 1-Pcs Scallop Utility Tong 不锈钢扇边夹

CODE	SIZE	
	(l cm)	(inch)
2250324	24.0	9.5
2250330	30.5	12
2250340	40.6	16

Heavy Duty Stainless Steel 1-Pcs VersaGrip® Tong 不锈钢夹

CODE	SIZE	
	(l cm)	(inch)
2250524	24.0	9.5
2250530	30.5	12
2250540	40.6	16



H/Duty Stainless Steel Scallop Tong with Lock
 不锈钢扇边夹



CODE	SIZE	
	(l cm)	(inch)
2240123	23	6
2240130	30	12
2240140	40	16

Gripper Tongs

Edlund multi-purpose heavy duty gripper tongs with unique flat paddle are ideal for separating frozen burger patties or for a firmer grip on platters. These tongs feature heavy duty replacement stainless steel spring and are available with or without patented locking mechanism.



Heavy Duty Utility Tong
 全钢夹 **GOURMET STEEL**

CODE	SIZE (l cm)
2260222	22.8
2260230	30.4
2260240	40.6



Stainless Steel Utility Food Tong with Plastic Handle
 彩色胶柄不锈钢夹 **GOURMET STEEL**

CODE	SIZE
	(l cm)
2260109-xx	22.8
2260112-xx	30.4
2260116-xx	40.6
2260118-xx	45.0

*Available Color

BL RD YL GR

When ordering Blue Tong add **CODE** suffix to item number (example: 2260109-BL)

Economy Stainless Steel Food Tong
 经济型不锈钢物夹有锁圈

CODE	SIZE (l cm)
2260322	22.8
2260330	30.4
2260340	40.6



Stainless Steel Fork & Spoon Tong
 不锈钢叉 / 匙剪刀形夹子

CODE	SIZE (l cm)
2260519	19.0
2260522	22.8



Economy Stainless Steel Spaghetti Tong
 经济型不锈钢面夹

CODE	SIZE (l cm)
2260618	18

Self Calibrated Stainless Steel Water Resistant Digital Scale

- All stainless steel body
- Submersible, for easy cleaning
- Self-calibrating
- Dual Housing Technology™ to prevent corrosion
- Scale Within a Scale™ design to help protect internal components against damage due to accidental shock
- CUL/UL/CE approved dual voltage AC power supply included; also operates on 4 AA batteries
- Most finite readout in the industry
- NSF Certified



CODE	WEIGHT (kg/gr)
2270105	5/1, 230V



Digital Portion Control Scale With Plastic Body and Stainless Steel Platform 电子食量控制秤

CODE	WEIGHT (kg/gr)
------	-------------------

2270205 5 / 1

Feature: all solid state electronic; 5 7/8 " x 6 3/4" removable s/s platform; automatic zero; 115 volt Adapter; also operates on 9 volt battery; automatic push button tare; low battery indication automatic shut-off feature when used with battery; ounce or gram mode selection switch



Feature: dishwasher safe; NSF Certified; S/S springs & mechanisms; All S/S housing;

Manual Ice Cream Scale 不锈钢秤

CODE	SIZE (w x h inch)	WEIGHT (kg/gr)
2270301	6 x 6.75	1 / 5
2270305	6 x 6.75	5 / 50
2270311	6 x 6.75	11 / 100

Stainless Steel Casing Manual Compact Ice Cream Weighing Scale 小型不锈钢秤

CODE	WEIGHT (oz)
2270416	16 / Pints



Standard Baker's Dough Scale 面团秤

CODE	WEIGHT (kg/gr)
2270504	4 / 5



Edlund's Compact Series scales have the same all-stainless steel body and internal mechanism as Premier Scales but in a more compact size. These scales are available in rotating or fixed dial models and feature removable platforms for weighing tacos, french fries or measuring ice cream overruns. NSF certified



Special wet-proof technology with IP65 rating and high brightness LED display adapted for use in various weighing environments.

Digital Weighing Scale 电子秤



CODE	SIZE (l x w x h cm)	WEIGHT (kg/gr)
2280103	22 x 27.5 x 16.5	3 / 0.5
2280106	23 x 27.5 x 16.5	6 / 1
2280115	24 x 27.5 x 16.5	15 / 2
2280130	25 x 27.5 x 16.5	30 / 10



Counter Top Digital Scale 电子秤

CODE	Platter SIZE (l x w cm)	WEIGHT (kg/gr)
2280801	18.2 x 22.6	1.5 / 0.2
2280803	18.2 x 22.6	3.0 / 0.5
2280807	18.2 x 22.6	7.5 / 1.0
2280815	18.2 x 22.6	15.0 / 2.0
2280830	18.2 x 22.6	30.0 / 5.0

- Suitable for Damp Environment
- Bright LED
- IP55
- Easy to read and operate
- High Speed
- 168 hours salt test passed



Digital Weighing Scale 电子秤



CODE	SIZE (l x w x h cm)	WEIGHT (kg/gr)
2280401	25.5 x 17.9 x 6.8	1 / 1
2280402	25.5 x 17.9 x 6.8	2 / 2
2280405	25.5 x 17.9 x 6.8	5 / 5

- 800 hour battery life (using alkaline battery)
- Easy to carry
- Removable & washable tray
- Splash-proof and precision in high humidity
- Large LCD : 14mm (5/8in) high
- Fast, accurate results
- Tare weighing function
- ** Adaptor not included.



Your key to fast, accurate, and user-friendly weighing transactions.

- Compact body
- High contrast LCD display
- Up to 99 PLUs programmable
- Equipped with 15 preset keys

Digital Price Computing Scale 计价电子秤



CODE	SIZE (l x w x h cm)	WEIGHT (kg)
2280215	22 x 22 x 22	15 / 5
2280230	23 x 22 x 22	30 / 10

- Special Printer Feature
- Clear Double Display
- Membrane Keyboard
- Powerful Network



Table Top Computing Scale w Printer 计价电子秤

CODE	SIZE (l x w x h cm)	WEIGHT (kg/gr)
2280915	37.0 x 55.0 x 45.6	15 / 2 - 5
2280930	37.0 x 55.0 x 45.6	30 / 5 - 10



Domestic Digital Scale 电子秤



CODE	SIZE (l x w x h cm)	WEIGHT (kg)
2280505	19 x 19 x 4	5



Pocket Micro Scale 迷你秤



CODE	SIZE (l x w x h cm)	WEIGHT (kg/gr)
2281102	16 x 7.6 x 1.0	0.2 / 0.1
2281103	16 x 8.1 x 1.8	0.3 / 0.1



Domestic Digital Scale
电子秤

CODE	SIZE (l x w x h cm)	WEIGHT (kg/gm)
2280603	21.8 x 15.6 x 3.6	3 / 1



Digital Weighing Scale
电子秤

CODE	SIZE (l x w x h cm)	WEIGHT (kg)
2280302	21 x 15 x 4	2



- AC or rechargeable battery
- Large, clear figures on the LCD display with back-light
- Simplified operations with only 5 pictograph keys
- Designed for Portability

Digital Platform Weighing Scale
平台电子秤

CODE	PLATFORM SIZE (l x w cm)	WEIGHT (kg)
2280706	38 x 38	60
2280715	38 x 38	150
2280730	48 x 48	300



- Large LCD display with LED backlight
- Battery provide up to 90 hours of continuous use
- Function include counting, check weighing, animal scale, accumulation and weighing unit shift

Digital Platform Weighing Scale
平台电子秤

CODE	PLATFORM SIZE (l x w cm)	WEIGHT (kg/gr)
2281260	80 x 60	600 / 50



Spring Dial Scale, Round Pan (Kg)
圆盘秤(公斤)

CODE	PAN SIZE (h cm)	WEIGHT (kg)
2290201	22.5	1
2290202	22.5	2
2290205	22.5	5
2290212	27.0	12
2290220	27.0	20
2290230	27.0	30



Spring Dial Scale, Flat Pan (Kg)
平盘秤(公斤)

CODE	PAN SIZE (l x w cm)	WEIGHT (kg)
2290101	16 x 18	1
2290102	18 x 20	2
2290105	25 x 25	5
2290110	25 x 25	10
2290112	25 x 25	12
2290115	25 x 25	15
2290120	25 x 28	20
2290130	25 x 28	30
2290150	30 x 30	50
2290160	33 x 38	60



Spring Dial Scale, Round Pan (Kg / Kt)
圆盘秤 (公斤/斤)

CODE	SIZE (h cm)	WEIGHT (kg/kt)
2290302	22	2 / 3
2290305	27	5 / 8
2290312	27	12 / 19
2290320	27	20 / 33
2290330	27	30 / 49



Spring Dial Scale, Flatpan (Kg / Kt)
圆盘秤 (公斤/斤)

CODE	SIZE (h cm)	WEIGHT (kg/kt)
2290902	18 x 20	2 / 3
2290905	18 x 20	5 / 8
2290912	18 x 25	12 / 19
2290920	18 x 28	20 / 33
2290930	18 x 28	30 / 49



Spring "HANGING" Scale
手提秤

CODE	SIZE (h cm)	WEIGHT (kg)
2290505	17.5	50
2290510	17.5	100



Metal Spring Weighing Scale
(Pounds / Kati)
港式圆形铁盘秤 (磅/斤)

CODE	SIZE (h cm)	WEIGHT (lb/kt)
2290410	26	10 / 7.5
2290426	26	26 / 20



Plastic Spring Dial Scale
(Hong Kong Style)
港式圆盘胶秤 (磅/斤)

CODE	SIZE (l x w x h cm)	WEIGHT (lbs/kt)
2290600	14 x 17.7 x 16	5 / 3.5



Plastic Dial Scale (Economy)
圆盘胶秤

CODE	SIZE (l x w x h cm)	WEIGHT (kg/gram)
2290700	16.8 x 13.8 x 16.0	2/10



Plastic Dial Scale (Economy)
椭圆胶秤

CODE	SIZE (l x w x h cm)	WEIGHT (kg/gram)
2290800	14 x 17.7 x 16	1/5



Digital Pocket Thermometer
电子温度计



CODE	SIZE (l x Ø cm)	RANGE (°C)
2300100	12 x 3.5	-50 to 150



Digital Pocket Thermometer
口袋式电子温度计



CODE	SIZE (l x Ø cm)	RANGE (°C)
2300300	15 x 1.9	-40 to 200



Digital Pocket Thermometer (°F or °C)
(Water Resistant)
口袋式电子温度计



CODE	SIZE (l x Ø cm)	RANGE (°C)
2300200	4.5 x 18	-10 / 200

Infrared Red Thermometer
手提红外线温度计



BG 32

CODE	RANGE (°C)
2300500	-20 to 320



BG 42R

CODE	RANGE (°C)
2300501	-35 to 630



BG 45R

CODE	RANGE (°C)
2300502	-32 to 535

with K-Type
thermocouple
built-in jack



Thermocouple for BG 45R

CODE
2300503



Folding Probe Thermometer
电子温度计



CODE	SIZE (l x Ø cm)	RANGE (°C)
2302200	15 x 1.9	-50 to 300



2-in1 Non-Contact IR Thermometer
电子温度计



CODE	SIZE (l x Ø cm)	RANGE (°C)
2302300	15 x 1.9	-30 to 220



Digital Probe Thermometer
电子温度计

CODE	SIZE (l x Ø cm)	RANGE (°C)
2302400	15 x 1.9	-30 to 220



Pocket Dial Thermometer
口袋式温度计

CODE	SIZE (l x Ø cm)	RANGE (°F/°C)
2300801	12.7	-10 / 110



Economy Thermometer
电子温度计



CODE	SIZE (l x w x h cm)	RANGE (°C)
2300700	17.6 x 6.6 x 2.5	-40 to 260

Sugar Refractometer
糖度計



Master-500

CODE	SPEC
6261602	BRIX: 0-90%

Master-53α

CODE	SPEC
6261601	BRIX: 0-53% (Automatic Temperature Compensation)

Digital Sugar Refractometer
糖度計



Pal-1

CODE	SPEC
6261603	BRIX: 0-53% ; Temperature : 9.0 to 99.9°C

Pal-Pâtissier

CODE	SPEC
6261605	BRIX: 0-85% ; Temperature : 9.0 to 99.9°C ; Baume (sugar) : 0 to 45°

Pal-2

CODE	SPEC
6261604	BRIX: 45-93% ; Temperature : 9.0 to 99.9°C

Salt Refractometer 盐度計



Master-28α

CODE	SPEC
6261801	Sodium chloride : 0.0 to 28.0g / 100g (Automatic Temperature Compensation)



Master-Bx / S28m

CODE	SPEC
6261701	Brix : 0.0 to 33.0% ; Sodium chloride : 0.0 to 28.0g / 100g

Digital Salt Refractometer 盐度計



PAL-ES2

CODE	SPEC
6261803	0.00 to 5.00 %



ES-421

CODE	SPEC
6261802	0.00 to 10.00 %

Digital PH Meter PH計



DPH-2



CODE	SPEC
6261901	0.0 to 14.0 ph

Salt & Kansui



MASTER-Ramen



CODE	SPEC
6261902	Soup concentration from 0 to 33.0% ; Kansui Baume degree of 0.0 to 10.0 (automatic temperature correction)



Dial Meat Thermometer
肉类温度计

CODE	SIZE (l x Ø cm)	RANGE (°C)
2301500	12.7 x 7	50 to 105



Candy / Fry Thermometer
糖浆/油炸温度计

CODE	SIZE (l cm)	RANGE (°F)
2300908	20.0	50 to 550
2300912	30.4	50 to 550



Meat Thermometer
肉类温度计

Blue Gizmo
The Original Roasting Specialist

CODE	SIZE (Ø cm)	RANGE (°C)
2301100	20	-54 to 88



Refrigerator / Freezer Thermometer
冰箱温度计

CODE	SIZE (l x Ø cm)	RANGE (°F / °C)
2301300	12.4 x 3.2	-40 - +80F -40 - +27 C



Coffee Thermometer
咖啡温度计

CODE	SIZE (l cm)	RANGE (°C)
2302220	20	-10 to 100



Freezer / Refrigerator Thermometer
冰箱温度计

CODE	SIZE (l x Ø cm)	RANGE (°C)
2301400	9.5 x 6	-30 to +30



Candy Thermometer
糖浆温度计

CODE	SIZE (l cm)	RANGE (°C)	
2301700	35	+80 to 200	Poly Plastic Holder
2301701	35	+80 to 200	Metal Holder



Candy / Jelly / Deep Fry Thermometer
糖浆/油炸温度计

CODE	SIZE (l x Ø cm)	RANGE (°C)
2301200	15.8 x 5.7	35 - 205



Bakery Thermometer (Polyamid Holder)
 烘焙温度计

CODE	SIZE (l x Ø cm)	RANGE (°C)
2301800	34	-10 to 60



Long-Ring Minute Manual Timer
 计时器

CODE	SIZE (Ø cm)	RANGE (minutes)
2302000	6.9	1 to 60



Large Single Station Timer
 大型计时器

CODE	SIZE (l w x h cm)	RANGE (hour)
2302124	17.8 x 15.2 x 10.2	24



Oven Thermometer
 烘箱温度计

CODE	SIZE (l x Ø cm)	RANGE (°C)
2301600	9.5 x 6	+65 to +285



Square Shape Digital Kitchen Timer
 方形电子计时器

CODE	RANGE (minutes)
2301902	100



Rectangle Shape Digital Kitchen Timer
 长方形电子计时器

CODE	RANGE (minutes)
2301903	100



Spark - L Gas Lighter
煤气点火器 (日本)

CODE	SIZE (l cm)
2310200	35.6
2310201	55.0



Gas Lighter, Non Refillable
不可冲气煤气点火器

CODE	SIZE (l cm)
2310300	23.4



Gas Refill for Lighter
煤气

CODE	SIZE (l cm)
2310401	15.8



C206, 190-GM Gas Canister
罐装煤气

CODE	CAP (lit)
2310600	190



Gas Cartridge
瓶装煤气

CODE	CAP (ml)	RANGE
2310800	250	



Electronic Gas Lighter with Battery
短管煤气点火器 (SM)

CODE	SIZE	
	(l cm)	(inch)
2310133	33.0	13
2310155	55.8	18



Short Gas Lighter, Refillable
不可冲气煤气点火器

CODE	SIZE (l cm)
2310400	15.8



Soudogaz Blow Torch
迷你烧烤式煤气点火器

CODE
6260600



Blow Torch (Use With Cartridge Gas)
煤气炉用罐装煤气

CODE
2310700



Round Bristle Pastry Brush (Plastic Handle)
胶柄毛圆油扫

CODE	SIZE (Ø cm)
2320815	1.5



Bristle Pastry Brush (Plastic Handle)
胶柄毛油扫

CODE	SIZE (l cm)	(inch)
2320125	2.5	1.0
2320130	3.0	1.25
2320135	3.5	1.5
2320150	5.0	2.0
2320160	6.0	2.5
2320170	7.0	3.0



Bristle Pastry Brush (Wooden Handle)
木柄毛油扫

CODE	SIZE (l cm)	(inch)
2321125	2.5	1.0
2321135	3.5	1.5
2321150	5.0	2.0
2321170	7.0	3.0



Bristle Pastry Brush (Plastic Handle)
胶柄毛油扫

CODE	SIZE (l cm)	(inch)
2321225	2.5	1.0
2321235	3.5	1.5
2321250	5.0	2.0
2321270	7.0	3.0



2321325 2321350 2321375 2321475

Pastry Brush (Wooden Handle)
木柄毛油扫



CODE	SIZE (l cm)	(inch)
2321325	2.5	1.0
2321350	5.0	2.0
2321375	7.5	3.0
2321475	7.5	3.0



Pastry Brush (Wooden Handle)
木柄羊毛油扫



CODE	SIZE (w x l cm)	(inch)
2320600	2.5 x 22.9	1.0
2320601	5.0 x 22.9	2.0
2320602	7.5 x 23.5	3.0



Nylon Pastry Brush (Wooden Handle)
尼龙毛刷

CODE	SIZE (l cm)	(inch)
2320900	3 x 19.5	1.0
2321000	5 x 21.0	2.0



Bristle Pastry Brush (Plastic Handle)
特級羊毛刷



CODE	SIZE (w x l cm)	(inch)
6080301	2.5 x 23.5	1.0
6080401	5.0 x 23.5	2.0



Stainless Steel "U" Shape Peeler 不锈钢'U'形刮刨

CODE	SIZE (l cm)	REMARK handle
2331801		Stainless Steel, Straight Teeth
2331802		Plastic Handle, Straight Teeth
2331803		Plastic Handle, Serrated Teeth



Plastic 'U' Shape Peeler 胶柄'U'形刮刨

CODE	SIZE (l cm)
2330305	5



Straight Blade Peeler (Plastic Handle) 直不锈钢刮刨

CODE	BLADE SIZE (l cm)
2330405	5

Stainless Steel H/Duty Vegetable Peeler 不锈钢刮刨

CODE	SIZE (l cm)	REMARK handle
2331601	5	Serrated Teeth
2331701	6	Straight Teeth



Potato Peeler 削皮刀

CODE	BLADE SIZE (l cm)
2362500	5.5





Egg Slicer & Wedger
两用切蛋器

CODE	SIZE
	(l x w h cm)
2330700	11.5 X 8.2 X 3.2



Stainless Steel Egg Slicer
钢分蛋器

CODE	SIZE
	(l cm)
2330800	14.5 x 7.5



Single Cast Aluminium Egg Slicer
铝制切蛋器

CODE	SIZE
	(l cm)
2331010	10.8



Stainless Steel 6-Section Egg Wedger
切蛋器 (6片)

CODE	SIZE
	(l cm)
2331200	2.5 x 6.5 x 21



White Garlic Press with Cleaner
压蒜头器

CODE	SIZE
	(l cm)
2331315	15



Stainless Steel Potato Ricer
不锈钢马铃薯压

CODE	SIZE
	(l cm)
2331400	30 x 13.2 x 11



Potato Masher (Wooden Handle)
木柄薯条压

CODE	SIZE	
	(Ø x l cm)	(inch)
2331500	12.7 x 60.9	5 x 24
2331501	13.3 x 60.9	5.25 x 24





Deluxe Stainless Steel Nut Crack
不锈钢坚果夹 / 蟹夹

CODE	SIZE (l cm)
2340217	17.5



Economy Chrome Nut Cracker
坚果夹 / 蟹夹

CODE	SIZE (l cm)
2340116	15



Stainless Steel Crab Stick
不锈钢蟹肉叉

CODE	SIZE (l cm)
2340420	20 Long



Nut / Crab Cracker
不锈钢坚果 / 蟹夹

CODE	SIZE (l cm)
2340316	17



Nickel Plated Apple Peeler (Suction Base)
手动苹果削皮器 (经济型)

CODE	SIZE (l cm)
2350300	19 x 32 x 10



Kali Professional Manual Apple Peeler (France)
手动苹果削皮器 (法国制)

CODE	SIZE
2350100	

Stainless Steel Manual Apple Wedger
不锈钢苹果切割器



CODE	SIZE (l cm)	TYPE
2350400	17 x 10.3 x 9	6 Sections
2350500	18 x 10.3 x 9	10 Sections





Cherry Stoner
櫻桃去核器



CODE	SIZE (l cm)
2350600	30 x 13.5 x 19



Cherry Stoner
櫻桃去核器



CODE	SIZE (l cm)
2351300	-



**H\ Duty Westmark Cast Aluminium
Olive Stoner**
铝制橄榄去核器

CODE	SIZE (l cm)
2350700	18.5



Stainless Steel Truffles Slicer
不锈钢松露刨



CODE	SIZE (l cm)
2350800	18.9 x 8.1 x 1.8



Pickles Slicer
黄瓜分割器



CODE	SIZE (l cm)
2350900	2.2 x 2.6 x 17.7



Stainless Steel Tomato Coring Tool
不锈钢番茄去芯器



CODE	SIZE (l cm)
2351000	1.9 x 10.7 x 0.9



**Stainless Steel Egg Top Cutter /
Knocker**
不锈钢敲蛋器



CODE	SIZE (l cm)
2351100	3.4 x 11



**Stainless Steel Egg Top
Cracker**
不锈钢敲蛋器



CODE	SIZE (l cm)
2351200	10 x 8.8

Manual Universal Corer For Fruits / Vegetable Slicer 不锈钢切菜器



CODE	SPEC	SIZE (Kg)
2380704	L. tube 90 mm - Graduated	0.05
2380705	L. tube 112 mm - Graduated	0.08
2380706	L. tube 112 mm - Graduated	0.09



Melon Baller 圆形挖器



CODE	SIZE (ø mm)	CODE	SIZE (ø mm)
2363210	10	2363222	22
2363215	15	2363225	25
2363218	18	2363230	30



Double Melon Baller 圆形挖器



CODE	SIZE (Ø mm)
2363325	22 & 25
2363330	22 & 30



Oval Melon Baller 椭圆形挖器



CODE	SIZE (Ø mm)
2363400	-



Oval Melon Baller (Fluted) 椭圆形挖器



CODE	SIZE (Ø mm)
2363401	-



Lemon Decorator / Canal Knife 橙/柠檬刮刀



CODE	SIZE (l cm)
2363600	-



Heart Shaped Scoop 心形挖器



CODE	SIZE (Ø cm)
2361433	3.3



Lemon Zester
橙/柠檬刮刀



CODE	SIZE
	(l cm)
2363500	-



Orange Peeler
橙刮刨器



CODE	SIZE
	(l cm)
2362800	4



Orange Peeler
橙刮刨器



CODE	SIZE
	(l cm)
2360100	-



Apple Corer
挖苹果芯刀



CODE	SIZE
	(ø mm)
2363800	16



Pineapple Coring Tool
凤梨去芯器



CODE	SIZE
	(Ø cm)
2361800	2.8



Heart Shaped Corer
心形挖器



CODE	SIZE
	(Ø cm)
2361500	-
2361600	-



Grapefruit Knife
柚子刀



CODE	SIZE
	(l cm)
2364400	-



Butter Curler Knife
牛油刮刀



CODE	SIZE
	(l cm)
2364000	-



Cherry Pitter
樱桃



CODE	SIZE
	(l cm)
2364500	-



Set of 4-Pcs Melon Peelers
西瓜刮刨器



CODE	SIZE (l cm)
2361700	8.9 x 10.5 x 12



Radish Curler
萝卜切割器



CODE	SIZE (l cm)
2364100	



Decoration Case of 28-tools
雕刻刀套

CODE	SIZE (l cm)
2362000	



**Set of 7 Decorating / Carvings Tools,
Abs Plastic Handle**
雕刻刀套



CODE	SIZE (l cm)
2361900	



**Nylon Bag Only for Garnishing
Carving Tools,7-Slots**
雕刻刀套袋



CODE	SIZE (l cm)
2364200	



**Set of 7-Pcs Garnishing
Set with Bag**
套装挖器



CODE	SIZE (l cm)
2362300	



Pastry Wheel
单轮滚动面团切割器



CODE	SIZE (l cm)
2363900	5



Pastry Wheel (Nylon Handle)
单轮滚动面团切割器



CODE	SIZE (l cm)
2362200	5.2 x 17.5



Stainless Steel Pizza Cutter (Wooden Handle)
不锈钢比萨刀 (木柄)

CODE	SIZE (l cm)
2362411	10



Cheese Grater With Basin
不锈钢奶酪刨



CODE	SIZE (l x w cm)
2371100	19.4 x 11



**Heavy Duty Serrated Pastry Wheel
(Nylon Handle)**
单轮滚动面团切割器



CODE	SIZE (l cm)
2362100	5.2 x 17.5



Stainless Steel Pizza Cutter (Plastic Handle)
不锈钢比萨刀 (胶柄)

CODE	SIZE (l cm)
2362410	10



Nutmeg Grater
不锈钢豆蔻刮刨



CODE	SIZE (l cm)
2371200	12.7



**3-Pcs Acc. Turning Grater
for Cheese / Vegetable**
不锈钢奶酪 / 蔬菜刮刨



CODE	SIZE (l cm)
2371300	20.3

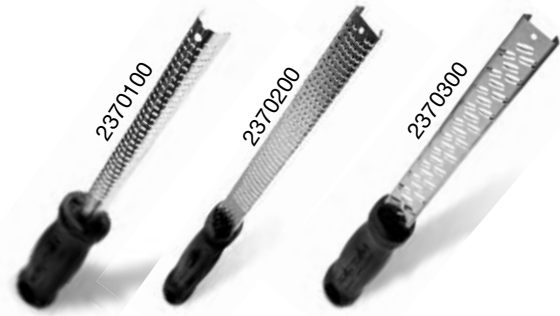

Classic Grater 磨/刨丝器

CODE	SIZE (l x w cm)	TYPE
2370100	12.38 x 1.0	
2370200	30.50 x 3.3	Zester
2370300	30.50 x 3.3	Classic Medium

Premium Zester / Grater, Red Handle 磨/刨丝器

CODE	SIZE (l x w cm)	TYPE
2450100	30.4 x 3.3	Zester
2450200	30.4 x 3.3	Ribbon
2450300	30.4 x 3.3	Extra Coarse



Gourmet Grater, Black Handle 磨/刨丝器

CODE	SIZE (l x w cm)	TYPE
2450400	30.4 x 7.62	Coarse
2450500	30.4 x 7.62	Ribbon
2450600	30.4 x 7.62	Zester
2450700	30.4 x 7.62	Large Shaver
2450800	30.4 x 10.1	Ultra Coarse



Slider Attachment for Gourmet Series 磨/刨丝器

CODE	SIZE (l x w cm)
2450900	7.62 x 6.6 x 5.7

Elite Zester 磨/刨丝器

CODE	SIZE (l cm)
2370900	



1-PC Full Zester 磨/刨丝器

CODE	SIZE (l x w cm)
2451000	





Ginger Grater Boxed
磨/刨丝器



CODE	SIZE (l cm)
2371900	-



4-Sided Slant Grater
4面不锈钢刮刨

CODE	SIZE (l cm)
2371400	22.8



Stainless Steel Ginger/Lemon Grate
不锈钢刮刨

CODE	SIZE (l cm)
2371600	12 x 6



Stainless Steel Japanese Raddish Grater
钢磨姜丝刨

CODE	SIZE (w x l cm)
2371802	17 x 28.0
2371803	13 x 24.0
2371804	13 x 22.5
2371805	11 x 22.0



Grater
磨/刨丝器



CODE	TYPE
2372001	Fine
2372002	Medium
2372003	Coarse
2372004	Parmesan



4-Sided Straight Grater
4面不锈钢刮刨

CODE	SIZE (l cm)
2371500	22.8



Copper Japanese Raddish Grater
铜磨姜丝刨

CODE	SIZE (w x l cm)
2371706	6.5 x 12.0
2371709	8.9 x 16.0
2371711	11.0 x 22.0
2371712	12.0 x 23.0
2371713	13.0 x 25.5
2371714	14.5 x 28.5



Benriner Side Turning Vegetable Slicer 旋转式鱼生刨

CODE	SIZE (l cm)
2380200	11 x 7 x 5

Spare Blade 刨式鱼生刨刀

CODE	TYPE
2381401	Straight
2381402	Fine Teeth



Benriner Top Turning Vegetable Slicer 旋转式鱼生刨

CODE	SIZE (l cm)
2380300	5.5 x 4.5 x 10

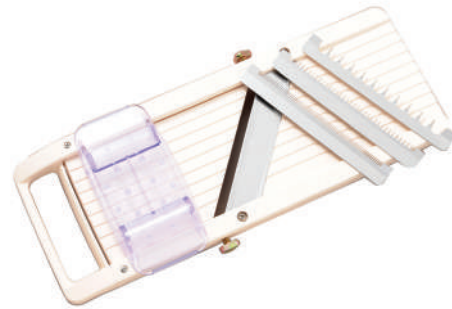
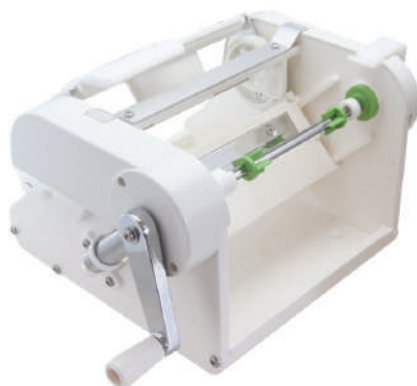

Benriner Vegetable Slicer 不锈钢有柄小单面刮刨

CODE	SIZE (l cm)	REMARKS
2380100	13 x 9	Small
2380101		Jumbo

Spare Blade 刨式鱼生刨刀

CODE	TYPE
2381301	Straight
2381302	Fine Teeth
2381303	Med Rough Teeth
2381304	Rough Teeth



Electric Turning Slice 电动鱼生刨

CODE	SIZE (l cm)
2381500	



Vegetable Slicer 蔬菜切割器

CODE	TYPE
2380400	Normal
2380421	2 - ln - 1
2380431	3 - ln - 1

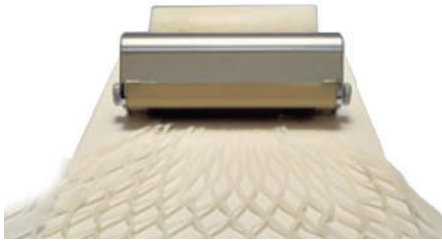

Roller Cutter "FISH NET" Maker
滚动萝卜切割器

CODE	SIZE (l cm)
2380500	



Manual Shredding Machine
滚动大葱切割器

CODE	SIZE (l cm)
2381600	



Electric Spring Onion Slicing Machine
电动切割器

CODE	SIZE (l cm)
2381700	



Ace Vegetable & Onion Slicer
搅葱头机

CODE	SIZE
2380600	17.7 x 15 x 27.9

La Mandoline

de BUYER
DEPUIS 1830

Complete mandoline with polymer composite pusher - Delivered with a double horizontal blade (straight & serrated) and a double Julienne blade (space 4 and 10 mm)

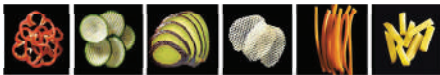

La Mandoline Swing Professional
不锈钢切菜器

CODE	SPEC	SIZE (l x w cm)
2380701	Black Colour	40 x 20



Viper Mandoline
不锈钢切菜器

de BUYER
DEPUIS 1830

CODE	SIZE (l cm)
2380700	44 x 18.5 x 15

Complete Mandoline with receptacle & pusher with horizontale blade & 2 Julienne 4 -10 mm

ROBUST AND PROFESSIONAL: Mandoline made of stainless steel and polymer composite. **COMPACT** - Easy to handle - Double-blades system: one single accessory for 2 uses. Folding upper foot for storage. **PRACTICAL:** Easy inserting of the blades on the side and easy thickness adjustment mechanism. **EFFICIENT:** Easy and precise cut. **SAFE:** Ergonomic pusher for maximum safety - Non-skid feet **MULTICUTS:** Includes double horizontal blades (straight and serrated) and Julienne blades (space 4 and 10 mm) to produce many cut styles: Julienne cuts, waffle cut, slice or crinkle cuts. Precise thickness adjustment until 10-mm.

Kobra V-Shaped Slicer 不锈钢切菜器



CODE	SIZE (l x w x hcm)	SPEC
2380703	36.5 x 12 x 11	Complete with pusher - Black



V-shaped blade: the blade penetrates the product easily. Optimised cutting angle at 19,3°. Cuts easily and perfectly all fruits and vegetables, even the softest ones (tomatoes, pears, etc.). Micro-serration of the blade enables the thinnest cut of fruit/ vegetable with skin and preserves their flesh composition. PRACTICAL & EASY: Easy to adjust the height of the cut: the thumb wheel integrated at the end of the handle allows the adjustment of the thickness up to 5 mm. Ergonomic handle. S/ steel ramp COMPACT The pusher clips on for easy storage. SAFE Protective. Silicone moulded anti-sliding handle. Anti-skid feet



Guard Stainless Steel Plastic Handle 不锈钢手摇柄

CODE	SIZE (l cm)
2380900	17.7 x 11.4

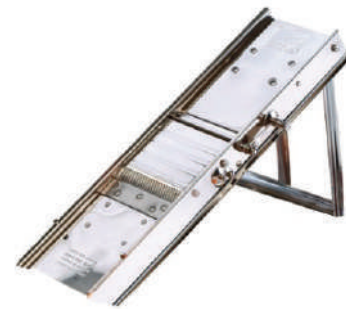

Stainless Steel Mandoline Slicer 不锈钢切菜器

CODE	TYPE (teeth)
2380838	38
2380844	44
2380860	60



* Complete with 3 blades & 1 safety guard

Mandoline Gourmet BC + Carriage 不锈钢切菜器



CODE	SIZE (l cm)
2381000	13.5 x 40 x 5.5



French Fry Cutter 薯条切割器

CODE	SIZE (l cm)
2381200	1 x 1 Cut



Potato Wedge Shape Cutter
薯条切割器

CODE	SIZE (l cm)
2381100	



Aluminium Hamburger Press
铝制汉堡压器

CODE	SIZE (ø cm)
2381300	10.8



Stainless Steel Food Mill - 3 Sieves
不锈钢食物轧机

CODE	SIZE (Ø cm)
2390324	24



Sieve Only for X530 & P1000
X530食物轧机筛

CODE	SIEVE SIZE (Ø mm)
2390510	1.0
2390515	1.5
2390520	2.0
2390530	3.0
2390540	4.0



Manual Burger Patty Machine
汉堡小馅饼机器

CODE	SIZE (l cm)
2381410	10
2381413	13



Food Mill P1000 Tinned On Tripod Stand
食物轧机 + 架

CODE	SIZE (l cm)	REMARK
2390100	39	3mm sieve



Inox Food Mill - 3 Disc
不锈钢食物轧机

CODE	SIZE (Ø cm)
2390331	31



X530 Inox Prof. Food Mill with 3 mm Sieve
不锈钢食物轧机

CODE	SIZE (Ø cm)
2390437	37



mallard ferrière

H/Duty Stainless Steel Juice Press 不锈钢榨汁机

CODE	SIZE (l cm)
2400500	



**GOURMET
STEEL**

Stainless Steel Orange Squeezer 不锈钢榨汁器

CODE	SIZE (l cm)
2400300	



Aluminium Standing Juice Press 铝制榨汁机

CODE	SIZE (l x w x h)
2400100	25.4 x 11.4 x 22.8



Stainless Steel Juice Press 不锈钢榨汁机

CODE	SIZE (l cm)
2400200	



Salad Spinner 沙拉搅拌器



Manual

CODE	SIZE (Ø x h)	CAP (lit)
2410110	33 x 43	10
2410120	43 x 52	20



Electric

Voltage 230V, Watts 200W, RPM 500

CODE	SIZE (Ø x h)	CAP (lit)
2410320	63 x 43	20



"Gourmet whip"

Especially designed for the kitchen, suitable for both hot and cold preparations. It can be stored in the bain-marie in warming cabinet, and in the refrigerator. Siphon 25 Cl is adapted for restaurant service.

- Keep warm in bain marie up to 75°C/165°F
- Three different sizes to suit any kitchen: 0.5 L, 1 L
- Inclusive: Stainless Steel Straight Tip, Tulip Tip, Star Tip, Cleaning Brush
- Ergonomic charger holder with non-slip silicone grip
- Dishwasher-safe
- NSF-certified
- Helps meet HACCP requirements

Gourmet Whip Cream Bottle (Hot & Cold) 不锈钢奶油打泡器罐

CODE	CAP (lit)
2340105	0.5
2340110	1.0

N2O Cream Charger 备用气弹

CODE
2340200



Cream profi whip plus

For the easy preparation of fresh whipped cream and other colds preparations. Stainless steel body and head, designed to withstand professional standards. Brush stainless steel body, head with removable piston and silicone quick release tab for hygienic cleaning. Comes with decorator fluted tip (with stainless steel thread), a charger holder and cleaning brush.

- Max. filling: 0.5 L, 1 L (1 US Pint, 1 US Quart)
- Tulip Tip & Star Tip included
- Ergonomic charger holder
- Dishwasher-safe
- NSF-certified
- Helps meet HACCP requirements



Profi Whip Cream Bottle 不锈钢奶油打泡器罐

CODE	CAP (lit)
2340205	0.5
2340210	1.0

N2O Cream Charger 备用气弹

CODE
2340200



Decorating Nozzle (Set of 3) 喷嘴

CODE
2340303

Injector Tip (Set of 4) 注射器

CODE
2340304

Full Stainless Steel Siphon Cream Whipper 不锈钢奶油打泡器罐

CODE	CAP (lit)
2420105	0.5
2420110	1.0

N2O Cream Charger 氧化亚氮备用气弹

CODE
2420300



- Specialist Plus Model
- The choice of the chef and food enthusiast.
- Made out of 100% stainless steel bottle + head, durable stainless steel tip and 2 decorator tips
- Perfect for cold and hot applications
- Dishwasher safe
- HACCP compliant and NSF listed for heavy food service use



Soda Siphon 苏打泡器罐

CODE	CAP (lit)
2420410-xx	1

*Available Color

 PP  OR

When ordering Orange Color add **CODE** suffix to item number (example: 2420410-OR)

CO2 Charger 二氧化碳备用气弹

CODE	CAP (lit)
2420500	



White Siphon Cream Whipper 奶油打泡器罐

CODE	CAP (lit)
2420205	0.5
2420210	1.0

N2O Spare Charger 氧化亚氮备用气弹

CODE
2420300





Lacy Cling Film 保鲜膜

CODE	SIZE (w cm x l m)
2430133	30 x 30
2430143	45 x 30
2430146	45 x 60



Lacy Aluminium Foil 铝锡箔纸

CODE	SIZE (w cm x l m)
2430233	30 x 30
2430243	45 x 30

Dispenser For Cling Film & Aluminium Foil 保鲜膜/铝锡箔纸收纳器

CODE	SIZE (l cm)
2430330	30
2430345	45





Knives





VIRTUGOLD

The pleasure of luxury

VirtuGold adds a hint of luxury, by creating this unique series. It features the finest quality stainless steel, a high performance cutting edge, excellent ergonomics, and comfort for the user. Its luxe design that exceeds the needs of cutting.

VIRTUGOLD



paring knife

3010110 4" 100mm



utility knife

3010213 5.25" 135mm
3010216 6.25" 160mm



vegetable knife

3010314 5.5" 140mm



carving fork

3010418 7" 180mm



carving knife

3010220 8" 205mm



bread knife

3010520 8" 205mm



serrated teeth

santoku knife

3010618 7" 180mm



chef's knife

3010720 8" 205mm





ViRTUBLACK

Design and Prestige



design by Jasper Stahl
Jasper Stahl



German
Design Award
NOMINEE 2013

DESIGN PLUS
Ambiente Frankfurt 2012



ViRTUBLACK

This prestigious forged series has been well accepted by contemporary Chefs. With a black coloured stainless steel, sublime style and the anti-glare, it makes this a unique knife series. It's sophisticated design provides good handling, balance, safety and hygiene.

VirtuBlack won the 2012 Design Plus Award and was nominated for the 2013 German Design Award at Messe Ambient in Frankfurt.



DESIGN PLUS
Ambiente Frankfurt 2012

German
Design Award
NOMINEE 2013

GARANTIA
ACPP
DE QUALIDADE
PRO
ASSOCIAÇÃO DE COZINHEIROS
PROFISSIONAIS DE PORTUGAL

peeling knife

3010907 2.75" 70mm



paring knife

3011008 3.25" 85mm



3011010 4" 100mm



utility knife

3011013 5.25" 135mm

3011016 6.25" 160mm



vegetable knife

3011114 5.5" 140mm



ViRTUBLACK

This prestigious forged series has been well accepted by contemporary Chefs. With a black coloured stainless steel, sublime style and the anti-glare, it makes this a unique knife series. It's sophisticated design provides good handling, balance, safety and hygiene.

VirtuBlack won the 2012 Design Plus Award and was nominated for the 2013 German Design Award at Messe Ambient in Frankfurt.

carving fork

3011218 7" 180mm



carving knife

3011020 8" 205mm



bread knife

3011320 8" 205mm



serrated teeth

ham knife

3011422 8.5" 220mm



santoku knife

3011518 7" 180mm



granton

chef's knife

3011620 8" 205mm





ViRTUBLACK

This prestigious forged series has been well accepted by contemporary Chefs. With a black coloured stainless steel, sublime style and the anti-glare, it makes this a unique knife series. It's sophisticated design provides good handling, balance, safety and hygiene.

VirtuBlack won the 2012 Design Plus Award and was nominated for the 2013 German Design Award at Messe Ambient in Frankfurt.

carving set

3011700



BlackMaster block

3011900

block only
3011300 white



BlackPrestige block

3011901

magnetic block
only
3011301 white





知 Asian FUKUI

This exceptionally designed asian series is made with high quality stainless steel. The blades are made extremely sharp to mimic the traditional japanese style. Designed specifically for lovers of Japanese cuisine.



知 Asian

For lovers of japanese cuisine



3012010

paring knife

4" 100mm



3012112

petty knife

4.75" 120mm



3012215

deba knife

6" 150mm



3012317

usuba knife

6.75" 170mm



3012418

santoku knife

7" 180mm



granton

3012518

7" 180mm



3012620

gyuto knife

8" 205mm



serrated teeth

3012720

bread knife

8" 205mm

KNIVES

yanagiba knife



3012820

8" 205mm



3012823

9" 230mm



3012827

10" 265mm

chinese chopper



3012918

7" 180mm

3012920

8" 205mm



bladeMASTER

This classic and traditional German designed series has been well received around the world. This collection is trusted and preferred by Chefs around the world for its high quality stainless steel, excellent cutting edge, balance and comfortable grip.

Quality and Tradition



NSF/ ANSI standard 2
food equipment



peeling knife

3026607-xx 2.75" 70mm



***Available Color**

RD BL BK GR YE WH

When ordering Red Handle add **CODE** suffix to item number
(example: 3026607-RD)

paring knife

3020109-xx 3.5" 90mm
3020110-xx 4" 100mm



***Available Color**

RD BL BK GR YE WH

When ordering Red Handle add **CODE** suffix to item number
(example: 3020109-RD)

utility knife

3020215-xx 6" 150mm



***Available Color**

RD BL BK GR YE WH

When ordering Red Handle add **CODE** suffix to item number
(example: 3020215-RD)

carving knife

3020320-xx 8" 205mm
3020325-xx 10" 255mm



3026725-xx 10" 255mm



***Available Color**

RD BL BK GR YE WH

When ordering Red Handle add **CODE** suffix to item number
(example: 3020320-RD)

carving fork

3020619-xx 7" 180mm



*Available Color

RD BL BK GR YE WH

When ordering Red Handle add **CODE** suffix to item number (example: 3020619-XX)

santoku knife

3020718-xx 7" 180mm



granton

*Available Color

RD BL BK GR YE WH

When ordering Red Handle add **CODE** suffix to item number (example: 3020718-RD)

bread knife

3020520-xx 8" 205mm



serrated

*Available Color

RD BL BK GR YE WH

When ordering Red Handle add **CODE** suffix to item number (example: 3020520-RD)

chef's knife

3020420-xx 8" 205mm



3020423-xx 9" 230mm

3020425-xx 10" 255mm

3020430-xx 12" 305mm



*Available Color

RD BL BK GR YE WH

When ordering Red Handle add **CODE** suffix to item number (example: 3020420-RD)

Functional and Durable



professional*line*l

This classic and traditional German designed series has been well received around the world. This collection is trusted and preferred by Chefs around the world for its high quality stainless steel, excellent cutting edge, balance and comfortable grip.



NSF/ ANSI standard 2
food equipment

peeling knife

3020806-xx 2.5" 65mm

***Available Color**

RD BL BK GR YE WH BR

When ordering Red Handle add **CODE** suffix to item number
(example: 3020806-RD)



paring knife

3020908-xx 3" 75mm

3020910-xx 4" 100mm

3021108-xx 3" 75mm

3021110-xx 4" 100mm

***Available Color**

RD BL BK GR YE WH BR

When ordering Red Handle add **CODE** suffix to item number
(example: 3020908-RD)



serrated teeth

vegetable knife

3020913-xx 5" 125mm

3020915-xx 6" 150mm

***Available Color**

RD BL BK GR YE WH BR

When ordering Red Handle add **CODE** suffix to item number
(example: 3020913-RD)



decorating knife

3021012 4.75" 120mm



*Available Color

■ BK

santoku knife

3021518-xx 7" 180mm



granton

*Available Color

■ BK ■ GR

When ordering Black Handle add **CODE** suffix to item number
(example: 3021518-BK)

chef's knife

3026820-xx 8" 205mm



*Available Color

■ RD ■ BL ■ BK ■ GR ■ YE □ WH ■ BR

When ordering Red Handle add **CODE** suffix to item number
(example: 3026820-RD)

boning knife

3021610-xx 4" 100mm



*Available Color

■ RD ■ BL ■ BK ■ YE

When ordering Red Handle add **CODE** suffix to item number
(example: 3021610-RD)

3021713-xx 5" 125mm

3021715-xx 6" 150mm



3021813-xx 5" 125mm semi flex

3021815-xx 6" 150mm semi flex



*Available Color

■ RD ■ BL ■ BK ■ GR ■ YE □ WH

When ordering Red Handle add **CODE** suffix to item number
(example: 3021713-RD)

fillet knife

3021418-xx 7" 180mm flex
 3021421-xx 8.25" 210mm flex



*Available Color

RD BL BK GR YE WH

When ordering Red Handle add **CODE** suffix to item number
 (example: 3021418-RD)

carving knife

3022420-xx 8" 205mm
 3022425-xx 10" 255mm



*Available Color

RD BL BK GR YE WH

When ordering Red Handle add **CODE** suffix to item number
 (example: 3022420-RD)

carving fork

Straight

3022618-xx 7" 180mm



Curve

3022718-xx 7" 180mm



*Available Color

RD BL BK GR YE WH BR

When ordering Red Handle add **CODE** suffix to item number
 (example: 3022618-RD)

bread knife

3023220-xx 8" 205mm



*Available Color

BK GR WH

When ordering Red Handle add **CODE** suffix to item number
 (example: 3023220-BK)

serrated

pastry knife

3022025-xx 10.25" 260mm



OFFSET sandwich knife

3022018-xx 7" 180mm
 3022023-xx 9" 230mm



*Available Color

BK WH

When ordering Black Handle add **CODE** suffix to item number
 (example: 3022025-BK)

serrated

serrated

bread knife

- 3022125-xx 10" 255mm
- 3022130-xx 12" 305mm
- 3022136-xx 14" 355mm

*Available Color

- RD ■ BL ■ BK ■ GR ■ YE WH ■ BR

When ordering Red Handle add **CODE** suffix to item number
(example: 3022125-RD)



serrated

slicing knife

- 3021925-xx 10" 255mm
- 3021930-xx 12" 305mm
- 3021936-xx 14" 355mm

*Available Color

- RD ■ BL ■ BK ■ GR ■ YE WH ■ BR

When ordering Red Handle add **CODE** suffix to item number
(example: 3021925-RD)



granton

ham knife

- 3022230-xx 12" 305mm

*Available Color

- RD ■ BL ■ BK ■ GR ■ YE WH

When ordering Red Handle add **CODE** suffix to item number
(example: 3022230-RD)



granton

salmon knife

- 3022530-xx 12" 305mm
- 3022536-xx 14" 355mm

*Available Color

- RD ■ BL ■ BK

When ordering Red Handle add **CODE** suffix to item number
(example: 3022530-RD)



granton

ham knife

- 3022322-xx 9" 230mm
- 3022326-xx 10" 260mm
- 3022328-xx 11" 280mm

*Available Color

- RD ■ BL ■ BK ■ GR ■ YE

When ordering Red Handle add **CODE** suffix to item number
(example: 3022322-BK)



medium blade chef's knife

3023020-xx 8" 205mm



3023025-xx 10" 255mm

3023030-xx 12" 305mm



***Available Color**

RD BL BK GR YE WH BR

When ordering Red Handle add **CODE** suffix to item number
(example: 3023020-RD)

serrated blade chef's knife

3026925-xx 10" 255mm



serrated teeth

***Available Color**

RD BL

When ordering Red Handle add **CODE** suffix to item number
(example: 3026925-RD)

broad blade chef's knife

3022815-xx 6" 150mm



3022820-xx 8" 205mm

3022823-xx 9" 230mm



3022825-xx 10" 255mm



3022830-xx 12" 305mm

3022835-xx 14" 355mm



***Available Color**

RD BL BK GR YE WH BR

When ordering Red Handle add **CODE** suffix to item number
(example: 3022825-RD)

butcher knife, wide tip

3023325-xx 10" 255mm
3023330-xx 12" 305mm



*Available Color

RD BL BK GR YE

When ordering Red Handle add **CODE** suffix to item number
(example: 3023325-RD)

butcher knife

3022918-xx 7" 180mm
3022922-xx 8.5" 215mm
3022924-xx 9.5" 240mm
3022926-xx 10.25" 260mm



*Available Color

RD BL BK GR YE WH

When ordering Red Handle add **CODE** suffix to item number
(example: 3022918-RD)

cleaver 胶柄砍肉刀

3023118-xx 7" 180mm 0.5kg



*Available Color

RD BL BK YE WH

When ordering Red Handle add **CODE** suffix to item number
(example: 3023118-RD)

cleaver 胶柄砍肉刀

3023120-xx 8" 20mm 0.9kg
3023123-xx 9" 23mm 1.08kg



BK WH

When ordering Black Handle add **CODE** suffix to item number
(example: 3023120-BK)



Versatile and Alternative



solo

This perfect and versatile stamped series is ideal for professional and home cooks in the beginning stages of their career. A The SOLO collection is a result of meticulous production and R&D. Made from high quality stainless steel and a comfortable handle, makes cutting tasks easier.



peeling knife

3025108-xx 3.25" 85mm

*Available Color

 RD  BL  BK  GR  YE WH

When ordering Red Handle add **CODE** suffix to item number
(example: 3025108-RD)



paring knife

3025209-xx 3.5" 90mm

3025309-xx 3.5" 90mm

3025311-xx 4.25" 110mm

*Available Color

 RD  BL  BK  GR  YE WH

When ordering Red Handle add **CODE** suffix to item number
(example: 3025209-RD)



Steak knife

3025412 4.75" 120mm

*Available Color

 BK

serrated teeth



boning knife

3025514-xx 5.5" 140mm

*Available Color

 RD  BK  YE

When ordering Red Handle add **CODE** suffix to item number
(example: 3025514-RD)



carving fork

Curve

3025918-xx 7" 180mm



Straight

3025920-xx 8" 205mm



***Available Color**

BK WH

When ordering Red Handle add **CODE** suffix to item number
(example: 3025918-BK)

bread knife

3025620-xx 8" 205mm



***Available Color**

BK WH

serrated teeth

When ordering Red Handle add **CODE** suffix to item number
(example: 3025620-BK)

santoku knife

3025718 7" 180mm



***Available Color**

BK

granton

When ordering Red Handle add **CODE** suffix to item number
(example: 3025718-BK)

chef's knife

3025813-xx 5.3" 135mm

3025815-xx 6" 150mm



3025818-xx 7" 180mm



3025820-xx 8" 205mm



3025825-xx 10" 255mm



***Available Color**

RD BL BK GR YE WH

When ordering Red Handle add **CODE** suffix to item number
(example: 3020109-05)

steak set

3023504



carving set

3023502



kitchen set

3023503



SoloSolution block

3011903



Only block

3011303



BlackMaster block

3011900

block only
3011300 white



BlackPrestige block

3011901

magnetic block only
3011301 white



ProMaster block

3011902

block only
3011302



EUROPOULTRY

Series of knives which was developed to meet the needs of the professional dismantling of poultry.



boning knife

3026906 2.5" 65mm



3027008 3" 75mm



3027110 4" 100mm



3027210 4" 100mm



3027313 5" 125mm



3027413 5" 125mm



3027513 5" 125mm



Stamped blade: high-quality stainless steel with chromium-molybdenum-vanadium (X50 Cr Mo V15) Handle: PP - polypropylene.

skewer cheese knife  triangle®

3024700 6" 150mm

**IVO**CHEESE

fork tip cheese knife

3021211-xx 4.5" 115mm

*Available Color

 BK
 WH

When ordering Black Handle add **CODE** suffix to item number
(example: 3021211-BK)



skewer cheese knife

3026015 6" 150mm



spatula cheese knife

3026115 6" 150mm



parmesan cheese knife

3026411 4.3" 100mm

3026415 6" 150mm



cheese knife

3026221	8.25"	210mm
3026226	10,25"	260mm
3026230	12"	305mm



granton cheese knife

3026526	10.25"	260mm
3026534	13.5"	340mm



cheese knife

3027026	10.25"	260mm
3027034	13.5"	340mm



cheese knife 2 handle

3026336	14"	360mm
---------	-----	-------



wire cheese cutter

2330910	4"	100mm
2330913	9"	230mm



2330910



2330913

cheese knife set

3026700 " 100mm

Board Size
30cm



frozen knife

3062225 10" 255mm



serrated

VIRTUGOLD



carving set

3010800

knife 205mm
fork 180mm



virtu carving knife & fork 厨刀/肉叉

3023600 8" 203mm
3023601 7" 180mm



virtu bread knife

3023602 8" 205mm



dicing knife

double blade
3026423 9" 230mm

single blade
3026523 9" 230mm
3026536 14" 360mm



set of 13-pcs knife set

3023200

Bag Only
3023701





set of 15-pcs forged knife in case

3023201



set of 7-pcs garnishing set with bag

2362300



gadgets case

3023700



knife roll

3023701



3023702



cook's case

3023704



3023705



backpack for knives

3023703



DEXTER
THE EDGE SINCE 1919

knife guard, narrow 刀袋

3023910	10 x 2.5 cm
3023915	15 x 2.5 cm
3023920	20 x 3.0 cm
3023925	25 x 3.0 cm
3023930	30 x 3.8 cm



economy knife bag 装刀袋

3024000	47 x 44 cm
---------	------------



DEXTER
THE EDGE SINCE 1919

cut resistance glove 保护手套

3030100	S
3030101	M
3030102	L
3030103	XL



stainless steel butcher glove 不锈钢手套

IVO
CUTELARIAS

wrist length

3030201	S
3030202	M
3030203	L

elbow length

3030206	M
3030207	L



KNIVES

aluminium mesh apron 铝制网丝围裙

3030300 Full Size



aluminium mesh apron
铝制网丝围裙

3030301 Full Size



pvc thick apron
围裙

9111601-xx Full Size

*Available Color

BG BL BK GR YE WH

When ordering Yellow color add **CODE** suffix
to item number
(example: 9111601-YE)

bone saw 不锈钢锯

3130545 45cm blade

3130550 50cm blade

spare blade only

3130645 45cm

3130650 50cm





Built to be both tough and sanitary. A textured, slip-resistant, easy-to-clean polypropylene handle withstands both high and low temperatures. An impervious blade-to-handle seal provides the utmost in sanitary qualification. Stain-free, high-carbon steel blade, with an individually ground and honed edge, excels in commercial use. Made in USA. Items marked with the NSF logo are NSF Certified.

Chef Cook's Knife

厨刀

CODE	SIZE (cm)
3150120-xx	20.3
3150125-xx	25.0

*Available Color

GR WH YE RD BL TN

When ordering Green Handle add **CODE** suffix to item number (example: 3150120-GR)



Serrated Bread Slicing Knife

面包刀

CODE	SIZE (cm)
3150220	20.3
3150230	30.0



Straight Blade Slicing Knife

片刀

CODE	SIZE (cm)
3150330	30



Straight Blade, Scallop Slicing Knife

不锈钢针

CODE	SIZE (cm)
3150430	30



Duo Edge Santoku Knife

胶柄菜刀

CODE	SIZE (cm)
3150517	17.7
3150522	22.8



Scalloped Offset Sandwich Knife

三明治刀

CODE	SIZE (cm)
3150722	22.8



Narrow Filleting Knife

片鱼刀

CODE	SIZE (cm)
3150622	22.8





Sharpening Steel 胶柄磨刀棍



CODE	SIZE (l cm)
------	----------------

3140125-xx 25
3140130-xx 30

*Available Colour

RD BL BK GR YE WH

When ordering Blue Handle add **CODE** suffix to item number
(example: 3140125-BL)

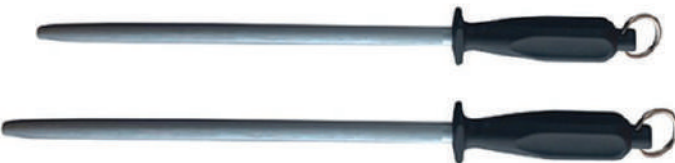

Sharpening Steel 胶柄磨刀棍



CODE	SIZE (l cm)
------	----------------

3140320 20 (black colour handle only)
3140325-xx 25
3140330-xx 30

*Available Colour

RD BL BK GR YE WH

When ordering Blue Handle add **CODE** suffix to item number
(example: 3140325-BL)



Professional "Diamond" Sharpening Steel 胶柄磨刀棍



CODE	SIZE (l cm)
------	----------------

3140230 30



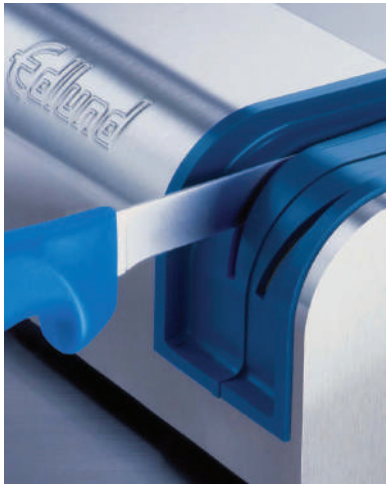

Commerical Electric Knife Sharpener, 230V
电动磨刀器

CODE	SIZE (l x w x h cm)
3040100	-



Accessories

Spare Grinding Wheel Assembly For #395 Electric Knife Sharpener
备用砂轮

CODE	SIZE (l x w x h cm)
3040101	-

Electric Diamond Stone Knife Sharpener (Black Red)
电动磨刀器(黑红)

CODE	SIZE (l x w x h cm)
3040200	14.5 x 14 x 9.5



Knife Sharpener
磨刀器



CODE	SIZE (l x w cm)
3040300	14 x 4.5



2-Sided "LARGE" Red Indian Carbon Sharpening Stone
两面磨刀石

CODE	SIZE (l x w x h cm)
3040500	20.3 x 7.6 x 5



Double Sided Sharpening Stone
两面磨刀石

CODE	SIZE (l x w x h cm)	
3040615	15.0 x 5 x 2.5	Small
3040620	20.3 x 5 x 2.5	Medium





**“ORIGINAL” Red Indian
Carbonum Sharpening Stone**
原装三番头磨刀石

CODE	SIZE (l x w x h cm)
3040700	20.3 x 7.6 x 5



Green Sharpening Stone
青色磨刀石

CODE	SIZE (l x w x h cm)	REMARK Roughness
3041000	20.3 x 5 x 5	200



**Orange Sharpening Stone,
Fuji #1000**
磨刀石

CODE	SIZE (l x w x h cm)	REMARK Roughness
3041200	20.3 x 7.6 x 5	1000



Yellow Sharpening Stone
磨刀石

CODE	SIZE (l x w x h cm)	REMARK Roughness
3041100	20.3 x 7.6 x 2.5	4000

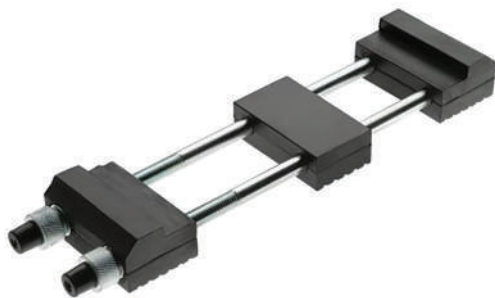

Sharpening Stone Holder
磨刀石座

CODE	REMARK
3040900	Hold Stone Between 5.5" - 8.5"



Magnetic Knife Bar
磁石刀座

CODE	SIZE (l cm)	(Inch)
3041445	45	18
3041530	30	12



8220124

Electric UV knife sterilizer 电刀消毒箱



CODE	POWER (WATT)	VOLTAGE	
8220116	16	230V / 50Hz	Holds 15 Knives
8220124	24	230V / 50Hz	Holds 20 Knives

- Made from Aisi 430 stainless steel.
- Chamber is closed by a smoked plexiglass door.
- Removable see-through plexiglass knives holder makes sanitation easier and allows sterilization without having to rotate the knives.
- Knives holder with built in drops collecting tray. (Only on 24w version).
- Mercury vapour lamp with wire screen protection.
- A safety microswitch switches the lamps on when the door is opened and switches them off when it is closed.
- The courtesy lamp, on 24w model, turns on only when the switch is "on" and the timer is at "0".



8220116



Stainless Steel Knife Sterilizing Holder (Removable Insert) 不锈钢刀箱

CODE	SIZE (l x w x h cm)
3050100	11.4 x 26 x 35

- NSF Certified
- Fully enclosed in stainless steel for increased sanitation
- Liquid sanitizing tank
- Removable inserts and tank for easy cleaning
- KSR-5000 can be mounted to a wall or to the side of a table



Stainless Steel Wall Hang Knife Rack (*Colour Coded) 钢刀箱 (彩色胶顶)

CODE	SIZE (l x w x h cm)
3050200	32 x 7 x 30
3050202	16 x 7 x 30

Knife Rack Cover 彩色胶顶

CODE
3050201



Economy Stainless Steel Knife Rack / Holder 不锈钢刀箱

CODE	SIZE (l x w x h cm)
3050300	30.4 x 30.4 x 6.35



KNIVES

Oyster Opener with Pom Riveted Handle 开蚝刀



CODE	SIZE (l x w x h cm)
3062300	-



Long Oyster Opener with Plastic Handle 开蚝刀



CODE	SIZE (l x w x h cm)
3062400	-



Long Oyster Opener with Plastic Handle 开蚝刀



CODE	SIZE (l x w x h cm)
3062500	-



Oyster Knife 黑柄开蚝刀



CODE	SIZE (l cm)
3061806	6



Oyster Knife with White Handle, Boston Handle 胶柄开蚝刀



CODE	SIZE (l cm)	Inch
3060207	10	4



Stainless Steel Oyster Opener with Wooden Handle (Long Tip) Japan 木柄开蚝刀

CODE	SIZE (l cm)
3060500	21



Oyster Knife Curve Tip with White Handle 胶柄开蚝刀



CODE	SIZE (l cm)	Inch
3060208	7.6	2.75



Stainless Steel Oyster Opener with Wooden Handle (Regular) Japan 木柄开蚝刀

CODE	SIZE (l cm)
3060600	15



Stainless Steel Poultry Shear 鱼类剪刀



CODE	SIZE (l cm)
3062125	25.5



Fish Shears 鱼类剪刀



CODE	SIZE (l cm)
3061919	19



Stainless Steel Special Crab Scissor with Long + Short Edge 钢螃蟹剪刀/长+短边

CODE	SIZE (l cm)
3061221	21



Kitchen Scissor, Heavy Duty 厨房用剪刀

CODE	SIZE (l cm)
3061319	19.5



Kitchen Scissor, Heavy Duty 厨房用剪刀

CODE	SIZE (l cm)
3061523	23



Kitchen Scissor, Heavy Duty 厨房用剪刀

CODE	SIZE (l cm)
3061420	20



Stainless Steel Kitchen Scissor with Plastic Handle, Economy Model 胶柄厨房用钢剪刀

CODE	SIZE (l cm)
3061721	21.5



Stainless Steel Kitchen Scissor with Red Plastic Handle (Original Zxq) 胶柄厨房用剪刀

CODE	SIZE (l cm)
3061617	17.0
3061618	18.0
3061619	19.5





STAINLESS STEEL DELUXE TABLE MANUAL CAN OPENER 不锈钢桌上开罐器

A tamper proof version of the S-11 is now available equipped with locking hardware



Full Stainless Steel S-11 Table Manual Can Opener 不锈钢桌上开罐器

CODE	SIZE (l cm)
3070300	40.6



Stainless Steel U-12 Table Can Opener with Stainless Steel Base 不锈钢桌上开罐器

CODE	SIZE (l cm)
3070400	40.6

Stainless Steel Spare Gear for S-11 / U-12 Can Opener 备用齿轮

CODE	SIZE (l x w x h cm)
3070501	-



Stainless Steel Spare Knife for S-11 / U-12 Can Opener 备用刀片

CODE	SIZE (l x w x h cm)
3070502	-



Table Can Opener with Quick Release & Stainless Steel Base 不锈钢桌上开罐器

CODE	SIZE (l cm)
3070600	40.6

Spare Gear for #G-2S Table Can Opener 备用齿轮

CODE	SIZE (l x w x h cm)
3070601	-



Spare Knife for #G-2S Table Can Opener 备用刀片

CODE	SIZE (l x w x h cm)
3070602	-



2 Speed Commercial Elect Can Opener #270 电动开罐器



CODE	SIZE (l x w x h cm)	POWER
3070100	-	230V

Replacement Knife & Gear Kit 备用齿轮&刀片

CODE	SIZE (l x w x h cm)
3070101	-



Single Speed Commercial Elect Can Opener 电动开罐器



CODE	SIZE (l x w x h cm)	POWER
3070200	-	230V

Spare Gear 备用齿轮

CODE	SIZE (l x w x h cm)
3070201	-



Spare Knife 备用刀片

CODE	SIZE (l x w x h cm)
3070202	-



Table Mounted Can Opener Stainless Steel Base 桌上开罐器



CODE	SIZE (l cm)	
3070863	63.5	Length
3070735	40.0	Standard

Spare for Can Opener 备用刀片 / 齿轮

CODE	TYPE
3071000	Blade Standard Opener
3070902	2.5 (Wheel - Standard)
3070904	4.0 (Wheel - Canmaster)



3070863



3070735



**“SWING-A-WAY”
Portable Can Opener**
开罐器

CODE	SIZE (l cm)
3071400	17.7



**Universal Turning
Can Opener**
开罐器



CODE	SIZE (l cm)
3071600	



**Manual Traditional
Can Opener**
开罐器

CODE	SIZE
3071212	S
3071215	L



**Round Wooden
Chopping Board**
圆木斩板

CODE	SIZE (Ø cm) (Ø inch)
3080107	17.7 7
3080108	20.3 8
3080109	22.8 9
3080110	25.4 10
3080111	27.9 11
3080112	30.4 12
3080113	33.0 13
3080114	35.5 14
3080115	38.0 15
3080116	40.6 16
3080117	43.0 17
3080118	45.7 18
3080120	50.8 20



Wing Turning Can Opener
开罐器



CODE	SIZE (l cm)
3071500	



Turning Can Opener
开罐器

CODE	SIZE (l cm)
3071117	17



**Stainless Steel Multi Purpose
Manual Can Opener**
不锈钢开罐器



CODE	SIZE (l x w x h cm)
3071300	11 x 6.7 x 2.9



**Rectangular Wooden Chopping
Board**
长方斩板

CODE	SIZE (l x w cm) (l x w inch)
3080205	12.7 x 20.3 5 x 8
3080206	15.0 x 25.4 6 x 10
3080207	17.7 x 27.9 7 x 11
3080208	20.3 x 30.4 8 x 12
3080209	22.8 x 33.0 9 x 13
3080210	25.4 x 35.5 10 x 14
3080211	25.4 x 60.9 10 x 24
3080212	30.4 x 43.0 12 x 17



Stainless Steel Chopping Board Stand Only
不锈钢斩板架

CODE	SIZE	
	(Ø cm)	(Ø inch)
3080316	40.6	16
3080318	45.7	18
3080319	49.5	19
3080320	50.8	20



Round Plastic Cutting Board
圆形胶斩板

CODE	SIZE	
	(Ø x h cm)	(Ø x h inch)
3080405	40 x 5.0	16 x 2.0
3080438	38 x 5.0	15 x 2.0
3080435	35 x 5.0	14 x 2.0
3080433	33 x 5.0	13 x 2.0
3080428	28 x 5.0	11 x 2.0
3080425	25 x 5.0	10 x 2.0
3080410-xx	40 x 10.0	16 x 4.0
3080506-xx	45 x 6.0	18 x 2.5
3080510-xx	45 x 10.0	18 x 4.0
3080515-xx	45 x 15.0	18 x 6.0
3080614-xx	48 x 13.5	19 x 5.3

*Available Color

BL GR YE WH RD BR

When ordering Blue Board add **CODE** suffix to item number
(example: 3080404-BL)



Aluminium Working Tables with Lower Shelf

CODE	SIZE	
	(l x w x h cm)	working surface
3083010	100 x 50 x 85	100 x 50 x 50 cm



Aluminium Frame Chopping Board

CODE	SIZE	
	(l x w x h cm)	working surface
3082040	40 x 40 x 87.5	40 x 40 x 5 cm



Aluminium Stand-alone working table

CODE	SIZE	
	(l x w x h cm)	total height
3084012	120 x 75 x 85	215cm

KNIVES

Colour Coded Cutting Boards

Safe food preparation is simple with the Colour Coded System that takes the risk out of cross-contamination. The boards are colour-coded by food group & they are non-absorbent and won't harbor foodborne bacteria. PE Boards surface won't dull knives, chip, crack, peel or warp. They're dishwasher safe and contamination can be further reduced with our matching Colour Coded knives & Brushes to complete a solution for food safety..



High Density Polyethylene Cutting Board

ColorCode cutting boards are the ultimate defense in the prevention of cross-contamination. Exceptionally durable and essential for safe food preparation. The high-density polyethylene is dishwasher safe. Made in the U.S.A.

High Density Color Coded Poly Cutting Board 长方形胶斩板

CODE	SIZE		THICKNESS
	(l x w x h cm)	(l x w x h inch)	
3080730-xx	30.4 x 45.7 x 1.27	12 x 18 x 0.5	1/2
3080838-xx	38.0 x 50.8 x 1.27	15 x 20 x 0.5	1/2
3080945-xx	45.7 x 60.9 x 1.27	18 x 24 x 0.5	1/2
3081030-xx	30.4 x 45.7 x 1.90	12 x 18 x 0.75	3/4
3081138-xx	38.0 x 50.8 x 1.90	15 x 20 x 0.75	3/4
3081245-xx	45.7 x 60.9 x 1.27	18 x 24 x 0.75	3/4

*Available Colour

BL GR TN WH RD YE

When ordering Blue Board add **CODE** suffix to item number (example: 3080730-BL)



Medium Density Color Coded PE Cutting Board 长方形胶斩板

CODE	SIZE		THICKNESS
	(l x w x h cm)	(l x w x h inch)	
3081230-xx	30.4 x 45.7 x 1.27	12 x 18 x 0.5	1/2
3081338-xx	38.0 x 50.8 x 1.27	15 x 20 x 0.5	1/2
3081445-xx	45.7 x 60.9 x 1.27	18 x 24 x 0.5	1/2
3081530-xx	30.4 x 45.7 x 1.90	12 x 18 x 0.7	3/4
3081638-xx	38.0 x 50.8 x 1.90	15 x 20 x 0.7	3/4
3081745-xx	45.7 x 60.9 x 1.90	18 x 24 x 0.7	3/4

*Available Colour

BL GR TN WH RD

When ordering Blue Board add **CODE** suffix to item number (example: 3080730-BL)



Rectangular PE Cutting Board 长方形胶斩板

CODE	SIZE		THICKNESS
	(l x w x h cm)	(l x w x h inch)	
3081801	30.50 x 45.80 x 2.5	12 x 18 x 1	1
3081802	30.50 x 45.80 x 5.0	12 x 18 x 2	2
3081803	30.50 x 60.90 x 2.5	12 x 24 x 1	1
3081804	38.00 x 50.80 x 2.5	15 x 20 x 1	1
3081805	38.00 x 50.80 x 5.0	15 x 20 x 2	2
3081806	40.60 x 121.9 x 2.5	16 x 48 x 1	1
3081807	40.60 x 121.9 x 5.0	16 x 48 x 2	2
3081808	45.80 x 60.90 x 2.5	18 x 24 x 1	1
3081809	45.80 x 60.90 x 5.0	18 x 24 x 2	2
3081810	45.80 x 76.00 x 2.5	18 x 30 x 1	1
3081811	45.80 x 76.00 x 5.0	18 x 30 x 2	2
3081812	45.80 x 91.40 x 2.5	18 x 36 x 1	1
3081813	45.80 x 91.40 x 5.0	18 x 36 x 2	2
3081814	45.80 x 121.9 x 2.5	18 x 48 x 1	1
3081815	45.80 x 121.9 x 5.0	18 x 48 x 2	2
3081816	60.90 x 121.9 x 2.5	24 x 48 x 1	1
3081817	60.90 x 121.9 x 5.0	24 x 48 x 2	2
3081818	101.6 x 243.8 x 2.5	40 x 96 x 1	1



Economy Rectangular Cutting Board 胶斩板

CODE	SIZE (l x w x h cm)	(l x w x h inch)
3081924	24.0 x 15.0 x 0.9	9.5 x 6.0 x 0.4
3081929	30.0 x 21.8 x 1.0	11.7 x 8.3 x 0.4
3081935	35.4 x 25.2 x 1.2	14.0 x 10.0 x 0.4
3081943	44.0 x 29.0 x 1.2	17.0 x 11.2 x 0.6
3081949	50.5 x 34.0 x 1.4	19.5 x 13.0 x 0.6



Stainless Steel Cutting Board Rack (Hold 6 Boards) 6格/7条三角形钢斩板架

CODE	SIZE (l x w x h cm)
3090206	-



Aluminium 1-Pc Meat Tenderizer 铝制肉锤

CODE	TYPE (weight)
3110100	300gram
3110101	450gram



Meat / Steak Tenderizers Mallet 木柄肉锤

CODE	SIZE (l x w cm)
3110200	7.6 x 7.6



Stainless Steel Flat Meat Tenderizer 不锈钢肉拍

PIAZA

CODE	SIZE (kg)
3110300	1.1 kg



Heavy Duty Manual Meat Tenderizer 嫩肉器

SIRMAN

CODE	SIZE (l x w x h cm)	Working Plate: 30 x 45cm
8101600	47.0 x 45.0 x 37.8	

Complete stainless steel construction.

- Operates without tearing meat fibres or changing shape of the meat, delivering a tender eye appealing, easy cookable and chewable product. Sliding on sealed bearings.
- Comes with a removable bottom cutting board for easy cleaning and sanitation.
- Clearance 130 mm.
- Tenderizes a 80 x 210 mm area each cycle.
- Bottom cutting board 300 x 450 mm.
- Easy removal, installation and cleaning of the blade set.
- 32 Removable and replaceable blade strips, no need to replace entire blade set.





3110415 15 knives
3110445 45 knives



3110516 16 knives
3110548 48 knives

Simply Better Meat Tenderizer 松肉器

- Meat Maximizer™ 15 & 45 Blades Meat Tenderizer with Removable Blade Cartridge
- Used by cooking enthusiasts' kitchens around the world.
- The patented, removable blade cartridge makes clean-up a snap. So easy to clean - the product has earned NSF certification - the only hand-held tenderizer in the industry with such recognition.
- Assembles and disassembles in just seconds.
- Fifteen Razor sharp knife blades cut through connective tissues that can make meat tough. Easy to use, this age old technique known as "jaccarding" makes faster, more flavorful, more tender meat! Helps to retain your meat's natural juices.
- Perfect for beef, chicken, pork, veal, turkey and game - readily penetrating flavor deeper into your favorite cuts.
- Reduce cooking time by up to 40 percent while helping meats to cook more evenly.
- Improves yield and "plate coverage" by reducing shrinkage.
- Tiny "heat channels" are created, resulting in faster penetration of marinades, providing more even cooking throughout the meat, and significantly reduced cooking times - all without changing the shape or appearance of your meat.
- Made of FDA compliant ABS and genuine 300 Series stainless steel metal components.
- Highest quality stainless steel results in sharper blades that will not dull, discolor, rust or change shape over time. Knives measure 50 RHC and are sharpened on both sides for prolonged performance that stays sharp - even after frequent use.

Dishwasher safe (top shelf recommended).

Super Tendermatic Meat Tenderizer 松肉器

- The Original Super Meat Tenderizer™
- Professional quality, 48 knife hand-held meat tenderizer
- Used in great restaurants around the world.
- Achieve better cooking results from less expensive cuts of meat or enhance the flavor and texture of even the finest meats with the original multi-knife, manual meat tenderizer.
- Razor sharp knife blades cut through connective tissues that can make meat tough. Simple to do, this age old technique known as "jaccarding" makes more flavorful, more tender meat! Also helps to retain your meat's natural juices.
- Perfect for beef, chicken, pork, veal, turkey and game - readily penetrating flavor deeper into your favorite cuts.
- Reduce cooking time by up to 40 percent, while helping meats to cook more evenly.
- Improves yield and "plate coverage" by reducing shrinkage.
- Tiny "heat channels" are created, resulting in faster penetration of marinades, providing more even cooking throughout the meat, and significantly reduced cooking times - all without changing the shape or appearance of your meat.
- Made of FDA compliant ABS and genuine 300 Series stainless steel metal components.
- Highest quality stainless steel results in sharper blades that will not dull, discolor, rust or change shape over time. Knives measure 50 RHC and are sharpened on both sides for prolonged performance that stays sharp - even after frequent use.

Dishwasher safe (top shelf recommended).



Precision Kitchen Tong / Pincer 不锈钢夹

PIAZZA

CODE	SIZE (cm)
2222330	30.0
2222323	23.5
2222315	15.0



40Deg Angled Precision Kitchen Pincer / Tweezer 不锈钢夹

PIAZZA

CODE	SIZE (cm)
2222430	30.0
2222423	23.5
2222415	15.0



Stainless Steel Precision "Kaiman" Fish Bone Pincer / Tweezer 不锈钢夹

PIAZZA

CODE	SIZE (cm)
2222518	18



Nikken Stainless Steel Tweezer 不锈钢鱼骨钳

CODE	SIZE (l x w x h cm)
3120110	10.5
3120112	12.0



Chrome Sharp Nose Plier
红柄电镀尖头钳

CODE	SIZE (l x w x h cm)
3120212	12.7
3120220	20.3



Chrome Flat Head Plier
红柄电镀平头钳

CODE	SIZE (l x w x h cm)
3120320	20.3



Heavy Duty Nabe Plier / Tong
夹子

CODE	SIZE (l x w x h cm)
3120422	22



Multi Purpose Double Boil Tong
炖盅夹

CODE	SIZE (l x w x h cm)
3120500	



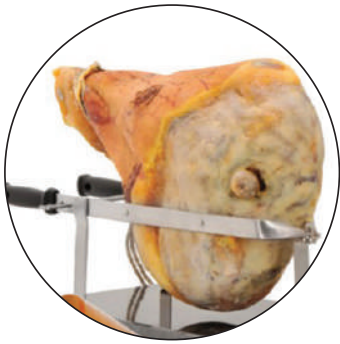

Ham Vice
火腿架

PIAZZA

CODE	SIZE
------	------

3130700



Fish Scaler (Nylon Handle)
鱼鳞刨刀

IVO
CUTELARIAS

CODE	SIZE (l cm)
------	----------------

3130823 23.5



**Stainless Steel
1-Pc Fish Scaler**
不锈钢鱼鳞刮

CODE	SIZE (l cm)
------	----------------

3130322 22.8



Ham Vice
火腿架

IVO
CUTELARIAS

CODE	SIZE (l cm)
------	----------------

3130900 39.5 x 16 x 40



**Fish Scaler with
Plastic Handle**
胶柄短头鱼鳞刮

CODE	SIZE (l cm)	
------	----------------	--

3130219 19.0 Short
3130224 24.7 Long



**Copper Fish Scaler
with Wooden Handle**
木柄鱼鳞刮

CODE	SIZE (l cm)
------	----------------

3130416 16
3130418 18



Pastry

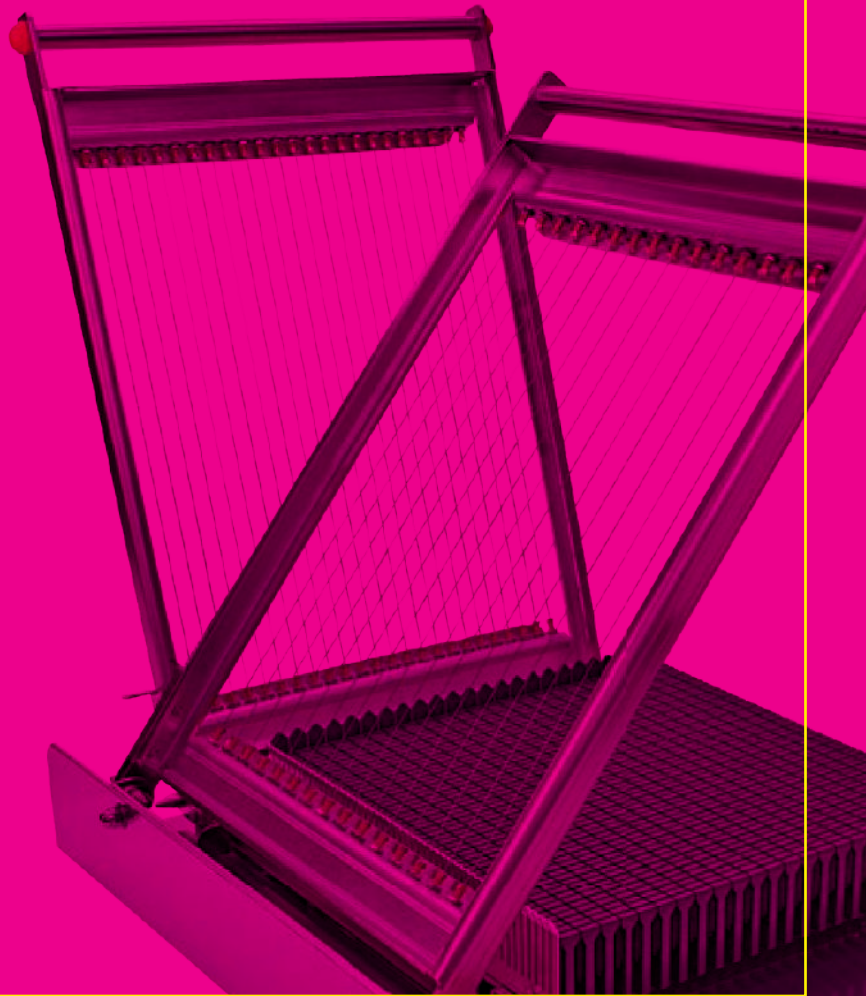



Prima Matera range of copper and stainless steel on the inside enables to enjoy the exceptional degree of conductivity of copper on all types of heat sources, including INDUCTION, thanks to its magnetic bottom. The cast stainless steel ergonomic handle are firmly riveted.



Induction
Copper Stainless Steel Sauce Pan
单柄铜汁锅

CODE	SIZE (Ø x h cm)	THICKNESS (mm)	CAPACITY (lit)
6010114	14 x 7.3	2	1.2
6010116	16 x 8.3	2	1.8
6010118	18 x 9.3	2	2.5
6010120	20 x 10.5	2	3.3
6010124	24 x 12.4	2	6.0



Induction
Copper Stainless Steel Saute Pan
单柄铜汁锅

CODE	SIZE (Ø x h cm)	THICKNESS (mm)	CAPACITY (lit)
6011716	16 x 5.5	2	1.0
6011720	20 x 5.8	2	1.8
6011724	24 x 6.6	2	3.0
6011820	20 x 7.2	2	1.7 / Conical Shape
6011824	24 x 8.2	2	3.1 / Conical Shape



Induction
Copper Stainless Steel Casserole Pot
双柄铜锅

CODE	SIZE (Ø x h cm)	THICKNESS (mm)
6010220	20 x 4	2
6010224	24 x 4	2
6010228	28 x 4	2
6010230	32 x 4	2



Induction
Copper Stainless Steel Casserole Pot
双柄铜锅

CODE	SIZE (Ø x h cm)	THICKNESS (mm)	CAPACITY (lit)
6010316	16 x 8.8	2	1.8
6010320	20 x 10.3	2	3.3
6010324	24 x 12.3	2	5.4
6010328	28 x 13.5	2	8.0



Induction
Copper Stainless Steel Casserole Pot
双柄铜锅

CODE	SIZE (Ø x h cm)	THICKNESS (mm)	CAPACITY (lit)
6011920	20 x 5.8	2	1.8
6011924	24 x 6.8	2	3.1
6011928	28 x 9.2	2	4.9

Inocuvrè range of copper pots and pans is especially well adapted to the table and making flambés or can be used simply to decorate the kitchen interior. It can also be used for cooking on medium-power heat sources. The walls are stainless steel on the inside, which makes for easy upkeep and removes the need for re-tinning. Riveted bronze handle.

Stainless Steel Lid

双柄铜锅

CODE	SIZE (Ø x h cm) (mm)	THICKNESS (mm)	CAPACITY (lit)
1240114	14	1	
1240116	16	1	
1240118	18	1	
1240120	20	1	
1240124	24	1	
1240128	28	1	



Inocuvrè "VIP"

Copper Mini Saucepan with Lid

小单柄铜汁锅

CODE	SIZE (Ø x h cm)	THICKNESS (mm)	CAPACITY (lit)
6010409	9 x 4.8	1.0	0.3



Inocuvrè "VIP"

Copper Stainless Steel Sauce Pan

单柄铜汁锅

CODE	SIZE (Ø x h cm)	THICKNESS (mm)	CAPACITY (lit)
6010510	10 x 5.5	1.5	
6010512	12 x 6.0	1.5	0.8
6010514	14 x 7.0	1.5	1.0
6010516	16 x 8.5	1.5	1.6
6010518	18 x 9.0	1.5	2.5
6010520	20 x 10.0	1.5	3.5



Inocuvrè "VIP" Copper Stainless Steel

Saute Pot with Cover

铜炒锅

CODE	SIZE (Ø x h cm)	THICKNESS (mm)	CAPACITY (lit)
6010624	24 x 7.2	2.0	3.2
6010628	28 x 9.2	2.0	5.5



Inocuvrè "VIP" Copper Stainless Steel

Stew Pot with Cover

铜炖锅

CODE	SIZE (Ø x h cm)	THICKNESS (mm)	CAPACITY (lit)
6010710	10 x 5.5	1.2	Mini
6010716	16 x 8.0	1.2	1.6
6010720	20 x 10.0	1.5	3.5
6010724	24 x 11.5	2.0	5.2



Inocuvrè "VIP"

Copper Stainless Steel Round Frying Pan

单柄圆形铜锅

CODE	SIZE (Ø x h cm)	THICKNESS (mm)
6010820	20 x 3.0	2.0
6010824	24 x 4.0	2.0
6010828	28 x 4.0	2.0





Inocuvrè "VIP"
Copper Stainless Steel
Oval Pan with 2 Handle
双柄椭圆形铜锅

CODE	SIZE (l x w x h cm)	THICKNESS (mm)
6010932	32 x 23 x 4.5	1.5
6010936	36 x 26.2 x 4.5	1.5



Inocuvrè "VIP"
Copper Round Pan / Dish
with 2 Handle
双柄圆形铜锅

CODE	SIZE (l x w x h cm)	THICKNESS (mm)
6012112	12 x 2.0	2.0
6012116	16 x 3.0	2.0
6012120	20 x 3.0	2.0
6012124	24 x 4.0	2.0



Inocuvrè "VIP"
Copper Saute Pan
单柄铜汁锅

CODE	SIZE (l x w x h cm)	THICKNESS (mm)	CAPACITY (lit)
6012216	16 x 5.0	1.2	1.0
6012220	20 x 6.0	1.2	1.8
6012224	24 x 6.5	1.2	3.0



Inocuvrè "VIP"
Copper Mini Frying Pan
单柄圆形铜煎锅

CODE	SIZE (l x w x h cm)	THICKNESS (mm)	CAPACITY
6012313	13 x 3.2	2	



Inocuvrè "VIP"
Copper Cover Only
铜锅盖

CODE	SIZE (l x w x h cm)	THICKNESS (mm)	CAPACITY
6011112	12	1.2	
6011114	14	1.2	
6011116	16	1.2	
6011118	18	1.2	
6011120	20	1.2	
6011124	24	1.2	
6011128	28	1.2	



X-Thick Round Copper Jam Bowl
加厚圆铜碗



CODE	SIZE (Ø x h cm)	CAP (L)
6011311	36 x 13	11



Round Copper Jam Bowl
圆铜碗



CODE	SIZE (Ø x h cm)	CAP (L)
6011409	38 x 12	9



Copper Sugar Pan
圆铜碗



CODE	SIZE (Ø cm)	CAP (L)
6011516	16	1.8
6011520	20	3.5



Silver & Copper Cleaner
银或铜清洗剂

CODE	CAPACITY (lit)	FOR
6011612	1.0	Silver
6011613	1.0	Copper



Copper Egg White Bowl
圆铜碗

CODE	SIZE (Ø cm)	CAP (L)	REMARKS
6011230	30 x 15	7	flexible ring

- Half-round copper mixing bowl designed for quickly beating egg whites.
- An essential hemispherical shape which helps incorporate air into the whites and which enables you to easily beat all the mixture preventing spillages.
- Thanks to copper: egg whites are beaten quicker; they are stiffer and whiter.
- Open rolled edge, ergonomic and functional: a safe grip, strong, simple and comfortable for a dynamic whipping; facilitates maintenance.





Stainless Steel X-Thick Mixing Bowl
铜清洗剂

CODE	SIZE (Ø cm)
2060515	15 x 6.0
2060518	18 x 7.0
2060521	21 x 8.0
2060524	24 x 9.4
2060527	27 x 10.5
2060530	30 x 11.5
2060533	33 x 12.5
2060536	36 x 12.5
2060539	39 x 14.5
2060542	42 x 16.0
2060545	45 x 16.5
2060550	50 x 19.0
2060555	55 x 20.0
2060560	60 x 23.0



**Stainless Steel Rounded Flat Base
Mixing Bowl**
不锈钢搅拌碗

PIAZZA

CODE	SIZE (Ø cm)	CAP cl
6011816	Ø 16.5	75
6011821	Ø 20.5	150
6011825	Ø 25.0	300
6011827	Ø 27.0	400
6011829	Ø 29.5	500
6011833	Ø 33.5	800
6011839	Ø 39.5	1400



**Stainless Steel Round Base Mixing
Bowl (2 Handle)**
双柄不锈钢圆底搅拌碗

PIAZZA

CODE	SIZE (Ø x h cm)	CAP (lit)
2060120	Ø 20 x 14.0	3.5
2060125	Ø 25 x 15.0	5.0
2060130	Ø 30 x 16.0	8.0
2060135	Ø 35 x 17.5	12.0
2060140	Ø 40 x 20.5	18.0



Stainless Steel Round Mixing Bowl
不锈钢圆底搅拌碗

CODE	SIZE (Ø cm)	CAP (lit)	CODE	SIZE (Ø cm)	CAP (lit)
2060716	16	0.75	2060730	30	6.0
2060718	18	1.0	2060733	33	8.0
2060720	20	1.5	2060736	36	10.0
2060722	22	2.0	2060739	39	13.0
2060724	24	3.0	2060744	44	16.0
2060726	26	4.0	2060747	47	20.0
2060728	28	5.0			

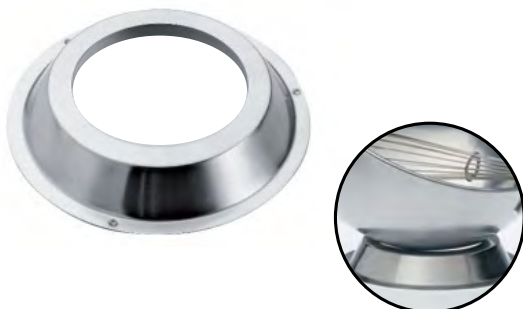

**Stainless Steel Ring Only for
Mixing Bowl / Colander**
不锈钢盘架

PIAZZA

CODE	SIZE (l cm)
2060200	



Mr Chef Stackable Glass Bowl
玻璃碗

CODE	SIZE	CAP
7090809	h 37mm - 1 1/2" Ø 88mm - 3 1/2"	8 cl - 2 3/4 oz
7090811	h 48mm - 2" Ø 112mm - 4 1/2"	18 cl - 6 oz
7090814	h 61mm - 2 1/2" Ø 140mm - 5 1/2"	36.5 cl - 12 1/4 oz
6011917	h 75mm - 6 3/4" Ø 170mm - 6 3/4"	75 cl - 25 1/4 oz
6011922	h 97mm - 3 3/4" Ø 220mm - 8 3/4"	160 cl - 54 oz
6011926	h 112mm - 4 1/2" Ø 260mm - 10 1/4"	256 cl - 86 1/2 oz
6011930	h 127mm - 5" Ø 300mm - 11 3/4"	396 cl - 134 oz



Pompei Stackable Glass Bowl
玻璃碗

CODE	SIZE	CAP
7090706	h 30mm - 1 1/4" Ø 60mm - 2 1/4"	3,9 cl - 1 1/2 oz
7090708	h 41mm - 1 1/2" Ø 80mm - 3 1/4"	10 cl - 3 1/2 oz
7090710	h 53mm - 2" Ø 105mm - 4 1/4"	24 cl - 8 oz
7090712	h 60mm - 2 1/4" Ø 120mm - 4 3/4"	35 cl - 11 3/4 oz
7090714	h 70mm - 2 3/4" Ø 140mm - 5 1/2"	57 cl - 19 1/4 oz
6012017	h 85mm - 3 1/4" Ø 170mm - 6 3/4"	106 cl - 35 3/4 oz
6012020	h 100mm - 4" Ø 200mm - 7 3/4"	170 cl - 57 1/2 oz
6012023	h 95mm - 3 3/4" Ø 230mm - 9"	245 cl - 82 3/4 oz
6012026	h 106mm - 4 1/4" Ø 260mm - 10 1/4"	365 cl - 123 1/2 oz



Plastic Utility Mixing Bowl
塑料搅拌碗

CODE	SIZE (Ø x h cm)	CAP (ltr)
6011717	17.5 x 7.5	1.0
6011723	23.0 x 10.5	2.5
6011727	27.5 x 11.5	4.5
6011732	32.0 x 15.0	6.0
6011736	36.0 x 17.0	9.0
6011740	40.0 x 19.0	13.0



PASTRY



High Heat Flat Shape Plastic Spatula
耐高温胶刮刀

CODE	SIZE	
	(l cm)	(inch)
2120910	24.0	10
2120914	35.5	14
2120916	40.6	16



Up to 200 °C

High Heat Silicon Spatula
耐高温刮刀



CODE	SIZE	
	(l cm)	(inch)
2120110	26.2 x 5.5	10
2120113	34.6 x 7.0	13
2120116	42.2 x 7.0	16



Up to 220 °C

"EXOGLASS" Spatula
耐高温纤维刮刀



CODE	SIZE	CODE	SIZE
	(l cm)		(l cm)
2120325	25	2120325	25
2120330	30	2120330	30
2120335	35	2120335	35



Narrow Blade Plastic Spatula
胶刮刀

CODE	SIZE	
	(l x w cm)	
2120710	24.0	10
2120714	35.5	14
2120716	40.6	16



Wooden Spoon
木勺

CODE	SIZE		CODE	SIZE	
	(l x w cm)			(l x w cm)	
2120510	25		2120518	45	
2120512	30		2120520	50	
2120514	35		2120532	80	
2120516	40		2120539	100	



High Heat Spoon Shape Plastic Spatula
耐高温刮刀

CODE	SIZE	
	(l x w cm)	(inch)
2121010	24.0	10
2121014	35.5	14
2121016	40.6	16



Up to 315 °C

Nylon Spatula / Scraper
胶刮刀

CODE	SIZE	
	(l x w cm)	(inch)
2120224	24.0	10
2120233	33.0	13
2120240	40.6	16



Flat Shape Plastic Spatula
胶刮刀

CODE	SIZE	
	(l x w cm)	(inch)
2120610	24.0	10
2120614	35.5	14
2120616	40.6	16



Spoon Shape Plastic Spatula
胶刮刀

CODE	SIZE	
	(l x w cm)	
2120810	24.0	10
2120814	35.5	14
2120816	40.6	16



Up to 204 °C

High Heat Nylon Spoon
耐高温尼龙勺



CODE	SIZE	
	(l x w cm)	(inch)
2120412	30.5	12
2120415	38.0	15



"Triangle" Spatula
橡膠鏟刀 (三角型)

CODE	SIZE (l cm)
6020101	26.5



Up to 80 °C

"Triangle" Spatula
(Heat Resistant)
橡膠鏟刀 (三角型)

CODE	SIZE (l x w cm)
6020901	13 x 22.5



Dough Scraper
胶刮刀

CODE	SIZE (l x w cm)
6061701	19.4 x 12.7

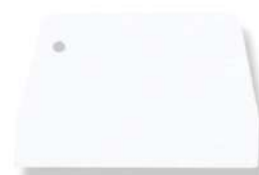

Dough Scraper, Hard Type
胶刮刀, 硬

CODE	SIZE (l x w cm)
6061801	13.4 x 9.5



Dough Scraper Soft Type
胶刮刀, 软

CODE	SIZE (l x w cm)
6061901	13.4 x 9.5



Dough Scraper Soft Type
塑膠刮板

CODE	SIZE (l x w cm)	REMARKS
6062001	13 x 10	5 pcs/pkt



Dough Scraper
半圓型塑膠刮板

CODE	SIZE (l x w cm)
6062101	15.9 x 10.4

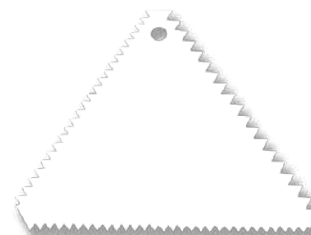

Triangle Comb / Scraper
三角齒刮板

CODE	SIZE (l cm)
6063100	11 x 11

PASTRY



**Rectangular Plastic
Decorating Comb**
2 Opp Sides
塑膠齒型刮板



CODE	SIZE (l x w cm)
6062301	11 x 7.6



**Rectangular Plastic
Decorating Comb**
4 Sided
塑膠齒型刮板



CODE	SIZE (l x w cm)
6062401	10.2 x 6.9



**Rounded Corner Square
Plastic Decorating
Comb** 2 Sides
塑膠齒型刮板



CODE	SIZE (l x w cm)
6062501	11 x 10.9



**Stainless Steel Triangle Profile
Comb / Scraper**
不銹鋼三角齒刮板



CODE	SIZE (l cm)
6062201	11 x 1

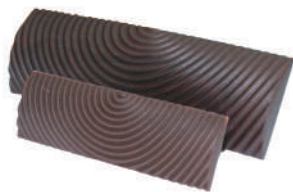

**Wood Silicon Rubber
Comb, 2 Pcs**
木輪根



CODE	SIZE (l cm)
6062601	



**Stainless Steel Dough
Cutter / Scraper
With Plastic Handle**
胶柄不銹鋼煎刀



CODE	SIZE (l cm)
6063200	11.6 x 13.0



**Stainless Steel Dough
Scraper with Plastic Handle**
胶柄不銹鋼煎刀

CODE	SIZE (l x w cm)
6062701	15.2 x 7



**Stainless Steel
OFFSET Dough
Scraper**
不銹鋼煎刀



CODE	SIZE (l x w cm)
6062801	21 x 12.7



Chocolate Cleaning Spatula
巧克力清洁锅铲



CODE	SIZE (l cm)
6062901	18 x 10



Stainless Steel Frosting Spatula
小刮刀



CODE	SIZE (l cm)
6071001	20.7



Up to 110 0 °C

Plastic Side Cake Scraper / Remover
小刮刀



CODE	SIZE (l x w cm)
6063300	22.2 x 2.6



Plastic Sugar Dredger
塑料糖瓶



CODE	CAP (L)
6020601	1



Plastic Fruit Strainer Set
塑料水果滤网



CODE	SIZE (l x w x h cm)
6031101	33.5 x 10.5 x 8



Round Funnel
圆形漏斗

CODE	SIZE (Ø cm)
6020702	5.0
6020703	7.6
6020704	10.0
6020705	12.7
6020706	15.2



Stainless Steel Oil Funnel with Drainer
钢有过滤网油漏斗

CODE	SIZE (Ø cm)
6020804	10.0





Straight Flexible Blade Spatula with Black Handle
胶柄直刮刀

CODE	SIZE (l cm)
6070315	15
6070318	18
6070320	20
6070323	23
6020327	27
6020330	30
6070335	35



Curved Spatula Flexible with Black Handle
胶柄曲刮刀

CODE	SIZE (l cm)
6070415	15
6070421	21
6070427	27



Serrated + Straight Blade Spatula
齿形锅铲

CODE	SIZE (l cm)
6070530	30
6070535	35



Straight Spatula with Black Handle
胶柄直锅铲

CODE	SIZE (w x l cm)
6070213	10 x 12.8



Angled Turner
胶柄锅铲

CODE	BLAZE SIZE (w x l cm)
6070613	8 x 13.5



Angled Burger Spatula
胶柄直角汉堡锅铲

CODE	BLAZE SIZE (w x l cm)
6070713	5.5 x 13



Small Spatula
小刮刀

CODE	SIZE (l cm)	
2130810	10	Straight
2103110	10	Angled



Spreader Spatula
刮刀

CODE	SIZE (l cm)
2130909	9



Angled Spatula
胶柄锅铲

CODE	BLAZE SIZE		REMARKS
	(w x l cm)	(inch)	
2102913	5 x 12.5	5	Slotted
2103013	5 x 12.5	5	Solid



Angled Spatula
胶柄锅铲

CODE	BLAZE SIZE	
	(w x l cm)	(inch)
2130913	5 x 12.5	5



Stainless Steel Icing Spatula
(Wooden Handle)
木柄刮刀

CODE	SIZE	CODE	SIZE
	(l cm)		(l cm)
2130115	15.0	2130130	30.4
2130120	20.0	2130135	35.5
2130125	25.4		



Stainless Steel Angled Spatula
(Wooden Handle)
木柄刮刀

CODE	SIZE
	(l cm)
2130315	15
2130320	20
2130325	25
2130330	30
2130335	35



Stainless Steel Icing Spatula
(Plastic Handle)
胶柄刮刀

CODE	SIZE	CODE	SIZE
	(l cm)		(l cm)
2130215	15.0	2130230	30.4
2130220	20.0	2130235	35.5
2130225	25.4		



Stainless Steel Angled Spatula
(Black Handle)
胶柄刮刀

CODE	SIZE	CODE	SIZE
	(l cm)		(l cm)
2130415	15.0	2130430	30.4
2130420	20.0	2130435	35.5
2130425	25.4		



Aluminium Platform Turning Stand
塑膠轉台



CODE	SIZE
	(ø x h cm)
6040101	30.9 x 14



Low Platform Plastic Turning Stand
塑膠轉台



CODE	SIZE
	(ø x h cm)
6040201	27 x 3.7



Tall Platform Plastic Turning Stand
塑膠轉台



CODE	SIZE
	(ø x h cm)
6040301	27 x 12 Pink
6040302	22 x 12 Cream

PASTRY

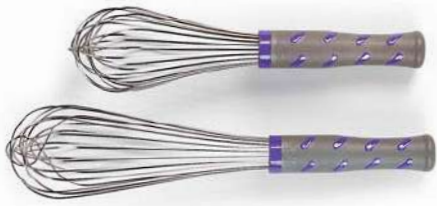

**Piano Whisk
with Nylon Handle**
轻巧试尼龙打蛋器



CODE	SIZE	
	(l cm)	(inch)
2150510	26	10
2150512	31	12
2150514	36	14
2150516	41	16
2150518	46	18



**French Whisk
with Nylon Handle**
法试尼龙打蛋器



CODE	SIZE		CODE	SIZE	
	(l cm)	(inch)		(l cm)	(inch)
2150610	25	10	2150618	45	18
2150612	30	12	2150620	50	20
2150614	35	14	2150622	56	22
2150616	40	16	2150624	61	24



Composite Handle Egg Whisk
不锈钢打蛋器



CODE	SIZE	
	(l cm)	(inch)
2150712	30.4	12
2150714	35.5	14
2150718	45.7	18



Egg White Whisk
打蛋器



CODE	CAP
	(l cm)
2151200	45



Egg Whisk
不锈钢打蛋器



CODE	CAP	
	(l cm)	
2150120	20	7.8
2150125	25	9.8
2150130	30	11.8
2150135	35	13.8
2150140	40	15.7
2150145	45	17.7
2150150	50	19.6

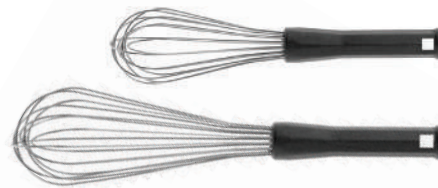

Composite Handle Wire Whisk
打蛋器



CODE	CAP		CODE	CAP	
	(l cm)	(inch)		(l cm)	(inch)
6021022	25	10	6021025	40	16
6021023	30	12	6021026	45	18
6021024	35	14	6021027	50	20



**Exoglass Mayonnaise
Rigid Wires Whisk**
打蛋器

CODE	SIZE
	(l cm)
6020540	40
6020545	45



**Egg Whisk
with Composite
Handle**
不锈钢打蛋器

CODE	SIZE	
	(l cm)	
2150425	25	7.8
2150430	30	11.8
2150435	35	13.8
2150440	40	15.7
2150445	45	17.7



Stainless Steel Mesh Flour Sieve
钢面粉筛

CODE	SIZE (Ø cm)	REMARKS
6071103	18, 21, 26	set of 3 pcs



Stainless Steel Flour Sieve
圆钢面粉筛

CODE	SIZE (Ø cm)	SPEC (maille)
6071314	35	14
6071340	35	40
6071350	35	50



Plastic Flour Sieve
圆形塑料面粉筛

CODE	SIZE (Ø cm)	SPEC (maille)
6071224	30.5	24
6071218	30.5	18
6071212	30.5	12



Plastic Sugar Sieve
圆形塑料面粉筛

CODE	SIZE (Ø cm)	SPEC (Maille)
6071240	18.5	40



Stainless Steel Flour Sieve
不锈钢面粉筛

CODE	SIZE (Ø cm)	SIZE (inch)
5112320	20	8
5112324	24	9
5112327	27	11
5112330	30	12
5112333	33	13
5112336	36	14
5112339	39	16
5112342	42	17



Stainless Steel "Mesh" Shaker
不锈钢密洞糖粉罐

CODE	SIZE (Ø x h cm)	CAP cc
2050715	6 x 8	150 cc
2050730	7 x 9.4	300 cc



Stainless Steel Salt / Pepper Shaker
不锈钢盐/胡椒罐

CODE	SIZE (Ø x h cm)	CAP cc
2050430	7 x 9.4	300 cc

PASTRY



Pastry Brush (Plastic Handle)
胶柄毛油扫

CODE	SIZE				
	(l cm)	(inch)			
2320125	2.5	1.00	2320150	5.0	2.00
2320130	3.0	1.25	2320160	6.0	2.50
2320135	3.5	1.50	2320170	7.0	3.00



Round Pastry Brush (Plastic Handle)
胶柄毛圆油扫

CODE	SIZE
	(Ø cm)
2320815	1.5



Medium Silicon Brush
硅刷

silikomart
professional

CODE	SIZE
	(l cm)
6080121	21



Barbecue Silicon Brush
硅刷

silikomart
professional

CODE	SIZE
	(l cm)
6080237	37



Pastry Brush (Wooden Handle)
木柄羊毛油扫



CODE	SIZE	
	(w x l cm)	(inch)
2320600	2.5 x 22.9	1.0
2320601	5.0 x 23.0	2.0
2320602	7.5 x 23.5	2.5



Pastry Brush (Plastic Handle)
特級羊毛刷



CODE	SIZE	
	(w x l cm)	(inch)
6080301	2.5 x 23.5	1.0
6080401	5.0 x 23.5	2.0



Boar Bristle Pastry Brush
毛油扫

CODE	SIZE	
	(w cm)	(inch)

Wooden Handle 木柄

2321125	2.5	1.0
2321135	3.5	1.5
2321150	5.0	2.0
2321170	7.0	3.0

Plastic Handle 胶柄

2321225	2.5	1.0
2321235	3.5	1.5
2321250	5.0	2.0
2321270	7.0	3.0



Counter Top Flour Brush
台刷

CODE	SIZE
	(l cm)
6080601	28.5
6080602	38.5



Plastic Measuring Cup
胶量杯

CODE	SIZE (l cm)	CAP (L)
6030902		0.25
6030905		0.5
6030910		1.0



Plastic Measuring Cup
胶量杯

CODE	CAP (L)
2160205	0.5
2160210	1.0
2160220	2.0
2160235	3.0
2160250	5.0



Polycarbonate Measuring Cup
量杯 **CAMBRO**

CODE	CAP (L)
2160102	0.25
2160105	0.5
2160110	1.0
2160120	2.0
2160140	4.0



Polycarbonate Measuring Cup
胶量杯



CODE	SIZE (cm)	CAP (lit)
2161002	7.1	0.2
2161005	8.7	0.5
2161010	11.3	1.0
2161020	14.8	2.0
2161030	17.2	3.0



Cast Aluminium Flour Scoop
铝制冰铲

CODE	CAP (oz)
2170205	5
2170212	12
2170224	24
2170238	38
2170258	58
2170285	85



Polycarbonate Flour Scoop
胶冰铲 **CAMBRO**

CODE	CAP (oz)
2170106	6
2170112	12
2170124	24
2170164	64



Stainless Steel Measuring Cup
不锈钢量杯



CODE	SIZE (l cm)	CAP (lit)
2160304	8	0.4
2160307	10	0.7
2160313	12	1.3
2160321	14	2.1



Pastry Wheel (Nylon Handle)
单轮滚动面团切割器



CODE	SIZE (l cm)
2362200	5.2 x 17.5



Lattice Cutting Roller
不銹鋼針車輪



CODE	SIZE (l x w x h cm)
6060601	19.3 x 12.8 x 4.3



Plastic "Lattice" Roller
塑料糕点“格子”滚筒

CODE	SIZE (l cm)
6060856	



**2 Way Cookie Cutter,
Fluted Wheel & Clip**
两用夾輪刀



CODE	SIZE (l cm)
6060501	20.3



**Serrated Pastry Wheel
(Nylon Handle)**
单轮滚动面团切割器



CODE	SIZE (l cm)
2362100	5.2 x 17.5



Docker Roller
不銹鋼針車輪



CODE	SIZE (l x w x h cm)
6060701	19.7 x 13.1 x 4.6



Plastic DOCKET Roller
塑料糕点滚筒

CODE	SIZE (l cm)
6060857	



CROISSANT Cutter
三角型麵團輪刀



CODE	DOUGH SIZE (Ø x l cm)
6061101	12 x 20



CROISSANT Cutter
三角型麵團輪刀



CODE	DOUGH SIZE (Ø x l cm)
6061201	9.7 x 22



Heavy Duty Multiple Dough Cutter
(With Marking)
多輪單用輪刀



CODE	SPEC
5110608	5 Wheels
5110607	7 Wheels



Heavy Duty 2 Sided Multiple Wheel Dough Cutter
(With Marking)
多輪單用輪刀



CODE	SPEC
6060105	5 Wheels
6060107	7 Wheels



Economy Multiple Wheel Dough Cutters
經濟型多輪單用輪刀

CODE	SPEC
6060205	5 Wheel
6060206	6 Wheel
6060207	7 Wheel



39 Blades Rolling Pin
多輪單用輪刀



CODE	SPEC (l x Ø cm)
6063039	51 x 4.1

PASTRY

Aluminium Round Cake Slicer 铝蛋糕夾層切割器



CODE	SIZE (l cm)
6070801	53 x 23



Cake Slicer Blade Only 蛋糕切片刀

CODE	SIZE
6070901	



Heavy Duty Wooden Rolling Pin with Stainless Steel Ball Bearing 木擀面棍

CODE	ROLLING SIZE	
	(l cm)	(inch)
6050613	33.0	13
6050615	38.0	15
6050618	45.7	18



Aluminium Alloy Rolling Pin with Handle 鋁合金活動中桿



CODE	SIZE (ø x l cm)
6050201	6 x 48



Aluminium Alloy Rolling Pin 鋁合金活動中桿



CODE	SIZE (ø x l cm)
6050101	2.5 x 33



Hard Anodized Rolling Pin with Removable Handle 鋁合金活動中桿



CODE	SIZE (ø x l cm)
6050301	8 x 55



Non-Stick Nylon Rolling Pin 不沾尼龙擀面棍



CODE	SIZE (ø x l cm)
6050401	4.5 x 50



Beechwood Rolling Pin 木擀面棍



CODE	SIZE (ø x l cm)
6050501	5 x 50

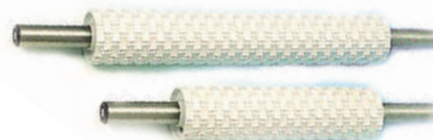

PVC Fluted Rolling Pin With Handle 擀面棍



CODE	ROLLING SIZE (ø x l cm)
6051600	6.5 x 40



Abs Basketwork 1.95 mm Rolling Pin With Stainless Steel Handle 擀面棍



CODE	ROLLING SIZE (ø x l cm)
6051700	6 x 38

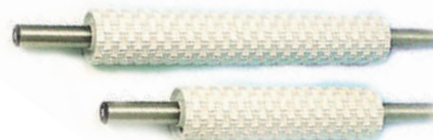



Plastic Fine Weave Rolling Pin
擀面棍



CODE	SIZE (ø x l cm)
6051800	5.1 x 25.5

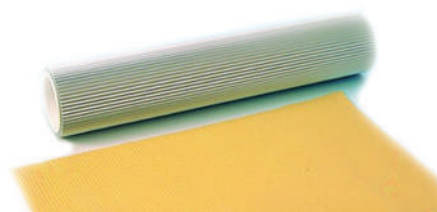

Aluminium Wavy Effect Rolling Pin
擀面棍



CODE	SIZE (ø x l cm)
6051900	4.7 x 24.1

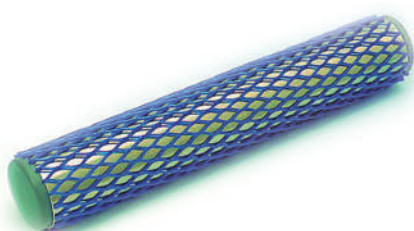

Aluminium Lozenge Decorating Rolling Pin
擀面棍



CODE	SIZE (ø x l cm)
6052000	2.5 x 15.2

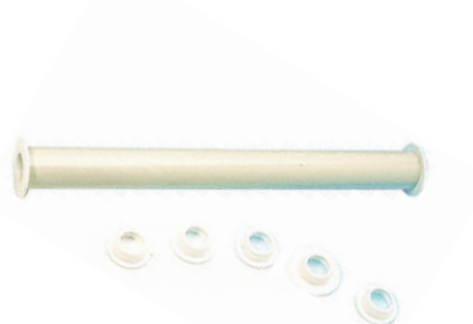

Adjustable Rolling Pin
擀面棍



CODE	SIZE (ø x l cm)
6052100	52



Aluminium Caramel Rolling Pin
铝擀面棍



CODE	SIZE (Ø x l cm)
6050901	3.5 x 22



Nickel Steel Nougat Rolling Pin
钢擀面棍



CODE	SIZE (Ø x l cm)
6050801	3.5 x 35



Aluminium Cannoli Cream Roll Mould
铝合金管



CODE	SIZE (Ø x l cm)	REMARK
6060901	2.5 x 14.5	Plain
6060902	2.5 x 14.5	Non-Stick



Aluminium Cream Horn Mould
铝合金螺管



CODE	SIZE (Ø x l cm)
6061001	2.8 x 13.5

PASTRY



Plastic Dough Nut Cutter
甜甜圈模



CODE	SIZE (Ø x h cm)	REMARKS
6061401	7.8 x 6.2	Small
6061402	8.4 x 6.2	Medium



Plastic Lattice Shape Cutter
波羅印



CODE	SIZE (Ø x h cm)
6061301	10.4 x 3.3



Plastic Slice Cake Divider (10 / 12 Slices)
分片器 (10/12片)



CODE	SIZE (Ø x h cm)
6061501	27.3 x 2.6

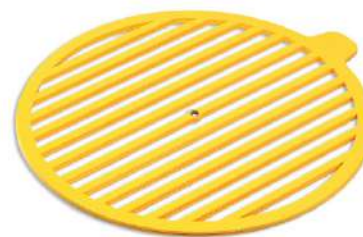

Plastic Adjustable Cake Decorator
活動裝飾器



CODE	SIZE (Ø x h cm)
6061502	31.9 x 0.5

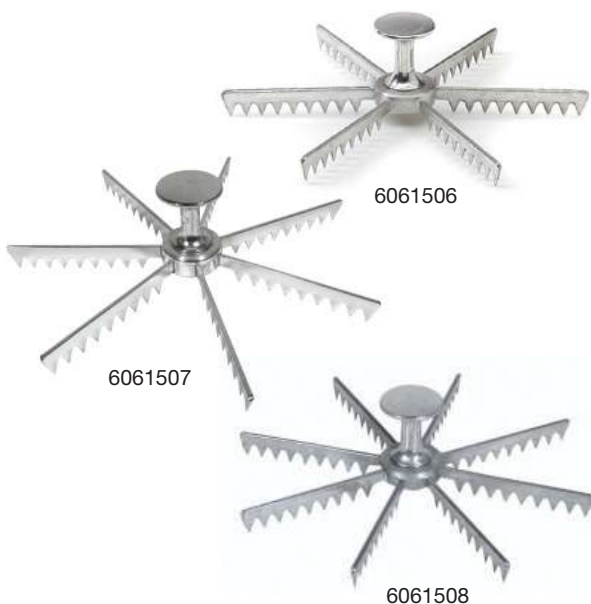

Cast Aluminium Pie Maker
馅饼刀

CODE	SIZE (Ø cm)
6061506	24
6061507	24
6061508	24

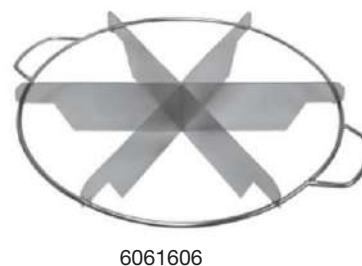

Stainless Steel Pie Cutter
馅饼刀

CODE	SIZE (Ø cm)	SPEC
6061606	25	6-Cut
6061608	25	8-Cut

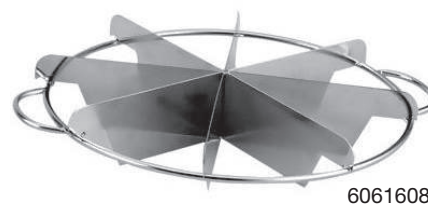



Set of 12 Pcs "Vol Au Vent" Cutter
12件切模



CODE	SIZE (Ø cm)
6213212	10.5 - 25



Interchangeable Baker's Blade
刀片



CODE	SIZE (l cm)	REMARKS
6213300		
6213301		Spare Blade



Stainless Steel Baker's Blade
整型刀



CODE	SIZE (l cm)
6213400	13.5



Stainless Steel Baker's Blade
整型刀



CODE	SIZE (l cm)	REMARKS
6213401	18	3 pcs /pkt



CCK Stainless Steel Carving Tools Set
钢雕刻工具

Decorating / Carvings Tools, Abs Plastic Handle
雕刻刀套



CODE	SIZE (l cm)	REMARKS
6210901		6 pcs set

CODE	SIZE (l cm)	REMARKS
2361900		7 pcs set



Plastic "Marzipan" Carving Tools
雕刻工具



CODE	SIZE (l cm)	REMARKS
6211101		9 pcs set

Plastic Marzipan Decorating Knife
雕刻刀



CODE	SIZE (l cm)	REMARKS
6211001		12 pcs

PASTRY

Plastic Cutter with Pusher 压花模



Puy Leaf 叶型

CODE	SIZE (Ø cm)
6210101	4.5, 3.7, 2.8



Mint Leaf 叶型

CODE	SIZE (Ø cm)
6210102	4.8, 4.0, 3.3



Small Daisy 花型

CODE	SIZE (Ø cm)
6210103	4.2, 3.4, 2.7, 2.2



Sunflower 太阳花

CODE	SIZE (Ø cm)
6210104	8.2



Sakura 樱花

CODE	SIZE (Ø cm)
6210105	3.4, 2.5, 2.1, 2.5



Leaf 叶型

CODE	SIZE (Ø cm)
6210106	4.5, 3.7, 2.8



Maple Leaf 3角叶型

CODE	SIZE (Ø cm)
6210107	6.0, 3.5



Design 图型

CODE	SIZE (Ø cm)
6210108	7.5 x 5.0 8.7 x 6.0



Snowflake 雪花

CODE	SIZE (Ø cm)
6210116	6.5, 5.0



Heart 心形

CODE	SIZE (Ø cm)
6210250	1.3, 1.0, 0.7



Flower Blossom 花形

CODE	SIZE (Ø cm)
6210251	1.3, 1.0, 0.7



Floral 花型

CODE	SIZE (Ø cm)
6210305	4.8, 4.2, 3.2



Daisy 花型

CODE	SIZE (Ø cm)
6210307	4.5, 2.7, 2.0

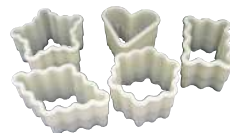

Assorted Cutter (Star, Heart, Rect, Round, Oval) (星星, 圆形, 长形, 旦形, 心形)

CODE	SIZE (Ø cm)
6210601	5.0, 6.0, 4.5 x 4.5, 7.0 x 4.0, 5.0 x 3.5



Assorted Cutter (Sq, Slanted, Sq, Boat, Round, Oval) (斜方形, 圆形, 船形, 旦形, 正方形)

CODE	SIZE (Ø cm)
6210701	6.0 x 4.5, 7.0 x 3.5, 7.0 x 4.0, 4.0 x 4.0, 4.0



Assorted Pastry Tweezer
塑料牙头花边夹

CODE	REMARKS
------	---------

6210401	Flat
6210501	Fluted

6210401

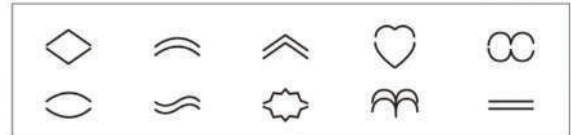

6210501



Plastic Numeric Cutter
数字胶花印

CODE	REMARKS
------	---------

6202615	15 pcs set
---------	------------



Plastic Alphabet Cutter
英文字母胶花印

CODE	REMARKS
------	---------

6202726	26 pcs set
---------	------------



Stainless Steel 'Numeric' Cutter
'数字' 钢切模

CODE	REMARKS
------	---------

5120113	10 pcs set
---------	------------



Stainless Steel 'Alphabet' Cutter
'英文字母' 钢切模

CODE	SIZE	REMARKS
------	------	---------

5120114	1.5 x 1.5 Approx. (1 cm)	26 pcs set
---------	-----------------------------	------------

Polypropylene Cutter



9 Pcs Round Cutter
9头圆形胶花印

CODE	SPEC
------	------

6200209	Fluted
6200309	Plain



9 Pcs Square Cutter
9头方形胶花印

CODE	SPEC
------	------

6200409	Fluted
6200509	Plain



9 Pcs Hexagon Cutter
9头六角形胶花印

CODE	SPEC
------	------

6200609	Fluted
6200707	Plain



7 Pcs Oval Cutter
7头椭圆形胶花印

CODE	SPEC
------	------

6200107	Fluted
6200807	Plain

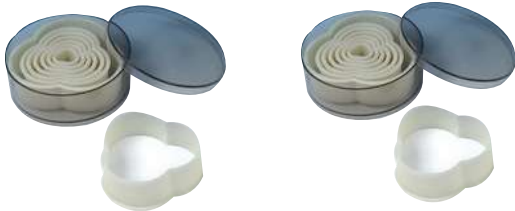

8 Pcs Trio Cutter
8头三角形胶花印

CODE	SPEC
------	------

6200908	Fluted
6201008	Plain



5 Pcs Star Cutter
5头星形胶花印

CODE	SPEC
------	------

6201105	Plain
---------	-------



7 Pcs Hexagram Star Cutter
7头星形胶花印

CODE	SPEC
------	------

6201205	Plain
---------	-------

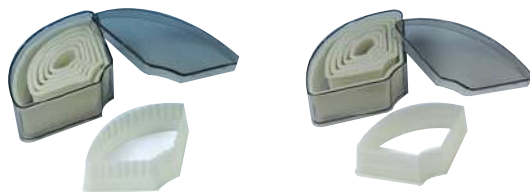

7 Pcs Fan Shape Cutter
7头扇形胶花印

CODE	SPEC
------	------

6201307	Fluted
6201407	Plain

Polypropylene Cutter



7 Pcs Heart Shape Cutter
7头心形胶花印

CODE	SPEC
6201507	Fluted
6201607	Plain



7 Pcs Half Moon Cutter
7头半月形胶花印

CODE	SPEC
6201707	Fluted
6201807	Plain



8 Pcs Rose Cutter
8头花胶花印

CODE	SPEC
6201908	Fluted
6202008	Plain



7 Pcs Pointed Oval Cutter
7头椭圆形胶花印

CODE	SPEC
6202207	Fluted
6202307	Plain

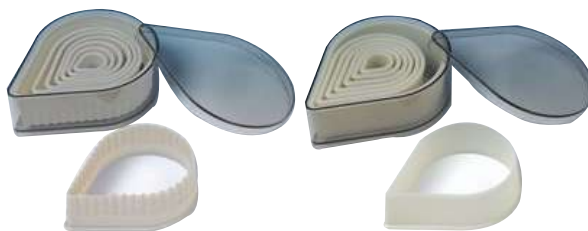

8 Pcs Teardrop Cutter
8头水滴胶花印

CODE	SPEC
6202408	Fluted
6202508	Plain



8 Pcs Flower Cutter
8头花胶花印

CODE	SPEC
6202108	Plain



Stainless Steel Cutter



Round Cutter
圆形光面钢切模

CODE	QTY (pcs)	TYPE
5120115	14	Plain
6202908	8	Fluted
6203009	9	Fluted
6203014	14	Fluted



OVAL Cutter
椭圆形钢切模

CODE	QTY (pcs)	SPEC
6203209	9	Plain
6203309		Fluted



HEXAGON Cutter
六角形钢切模

CODE	QTY (pcs)
5120108	6



Star Cutter
星形钢切模

CODE	QTY (pcs)
6203706	5



SQUARE Cutter
四方形钢切模

CODE	SIZE (l cm)	QTY (pcs)	TYPE
5120110		6	Plain



TRIANGLE Cutter
三角形钢切模

CODE	QTY (pcs)
5120112	6

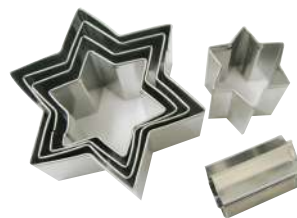

Hexagram Star Cutter
六角星形钢切模

CODE	QTY (pcs)
5120101	6



Heart Shape Cutter
心形钢切模

CODE	QTY (pcs)	TYPE
6203806	6	Plain
6203908	8	Fluted



Blossom Shape Cutter
梅花钢切模

CODE	QTY (pcs)
5120106	6



Semi Circle Shape Cutter
半圆形钢切模

CODE	QTY (pcs)
5120109	6



Tear Drop Shape Cutter
水滴型钢切模

CODE	QTY (pcs)
5120111	6



Assorted Shape Cookies Cutter
饼干钢切模

CODE	QTY (pcs)
5120107	6



Stainless Steel Cutter 钢切模

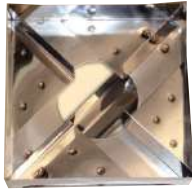

Windmill 切模

CODE	SIZE (l x w cm)
6211310	10 x 10



Double Square 方形切模

CODE	SIZE (l x w cm)
6211411	11 x 11

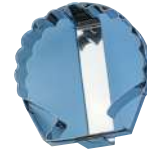

Single Scallop
扇贝切模

CODE	SIZE (Ø cm)
6211511	11



Double Scallop
扇贝切模

CODE	SIZE (Ø cm)
6211611	11

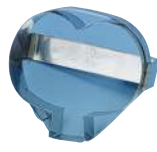

Single Apple
苹果切模

CODE	SIZE (Ø cm)
6211711	11

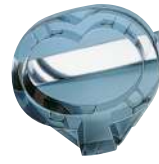

Double Apple
苹果切模

CODE	SIZE (Ø cm)
6211811	11



Single Pear
梨切模

CODE	SIZE (Ø cm)
6211911	11

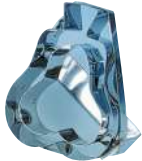

Double Pear 梨切模

CODE	SIZE (Ø cm)
6212011	11



Single Strawberry 草莓切模

CODE	SIZE (Ø cm)
6212111	11

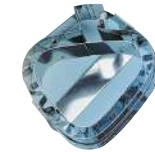

Double Strawberry 草莓切模

CODE	SIZE (Ø cm)
6212211	11

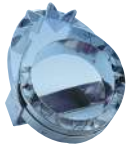

Double Pineapple 凤梨切模

CODE	SIZE (Ø cm)
6212411	11



Fir Tree 钢枞树切模

CODE	SIZE (h cm)
6212506	6.5
6212609	9.0
6212712	12.0



Holly Leaf
四季青切模

CODE	SIZE (h cm)
6212806	6

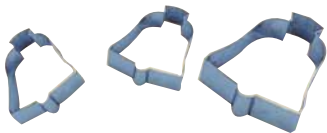

Bell 铃切模

CODE	SIZE (h cm)
6212903	5.5, 7.5, 9



Almond Pastry 杏仁糕点切模

CODE	SIZE (l cm)
6213012	-



Tinplated 镀锡切模

CODE	SIZE (l cm)
6213142	-

Stainless Steel Graduated Ruler For Pastry 不锈钢尺



CODE	SIZE (l x h cm)
6051101	65 x 5

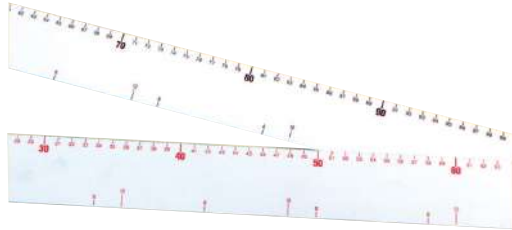

Plastic Graduated Ruler 塑料尺



CODE	SIZE (l x h cm)
6051001	64 x 5

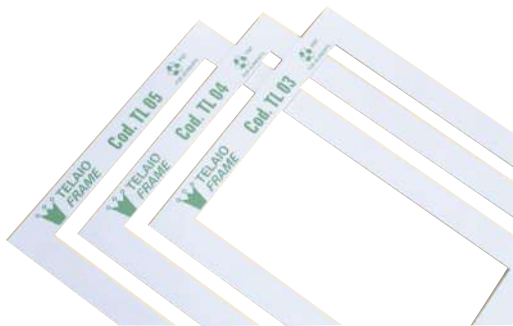

Plastic Ruler for Biscuit Frame 塑料尺



CODE	SIZE (l x h cm)
6051301	56 x 8.7



Plastic Frame for Biscuit 塑料架



CODE	SIZE (l x w cm)	SPEC (mm)
6051203	57 x 37	3
6051204	57 x 37	4
6051205	57 x 37	5

Set of 4 Pcs Stainless Steel Caramel Ruler 不锈钢焦糖尺



CODE	SIZE (l x w x h cm)	
6051401	50 x 1.5 x 1	2 pcs
	80 x 1.5 x 1	2 pcs

69 cm 2 Sided Plastic Decorating Comb 塑膠齒型刮板



CODE	SIZE	SPEC (mm)
6051501	1/2	1 side 2 mm, 1 side 3 mm
6051502	3/4	1 side 5 mm, 1 side 7 mm
6051503	7/8	1 side 2 mm, 1 side 2.3 mm & 5 mm
6051504	11/12	1 side 5 mm, 1 side 10 mm
6051505	13/14	1 side 10 mm straight teeth, 1 side 10 mm rounded teeth



Polycarbonate Nozzle



6090124



6090212

Assorted Nozzle Set 花嘴

GOURMET
STEEL

CODE	REMARKS
6090124	24 Pcs set
6090212	12 Pcs set



6093812



6090312

Pastry Nozzle 花嘴

GOURMET
STEEL

CODE	TYPE	REMARKS
6090312	Star	12 Pcs
6093812	Plain	12 Pcs



6090420

Assorted Nozzle 花嘴

GOURMET
STEEL

CODE	TYPE
6090420	20 Pcs
6090524	24 Pcs
6090660	60 Pcs



6090660



6090524



2 Pcs "BIRD NEST"
Pc Nozzle
花嘴

GOURMET
STEEL

CODE

6090701



2 Pcs "YULE LOG"
Pc Nozzle
花嘴

GOURMET
STEEL

CODE SIZE

(l cm)

6090801



Stainless Steel Pastry Nozzle
不锈钢裱花嘴



Plain

CODE SIZE
(Ø cm)

5131204	0.4
5131206	0.6
5131207	0.7
5131208	0.8
5131210	2.0
5131212	1.2
5131213	1.3
5131215	1.5
5131217	1.7
5131218	1.8
5131200	Set of 10



Star

CODE SIZE
(Ø cm)

5131304	0.4
5131306	0.6
5131307	0.7
5131308	0.8
5131310	2.0
5131312	1.2
5131313	1.3
5131315	1.5
5131317	1.7
5131318	1.8
5131300	Set of 10



80 Pcs Set Stainless Steel Nozzle 手工花嘴 (80粒裝)



CODE
6090980



Stainless Steel "SAINT-HONORE" Nozzle 手工花嘴



CODE	SIZE
	(l x w x h mm)
6091101	12 x 25 x 41



Stainless Steel Leaf Pipping Nozzle 葉齒手工花嘴



CODE	SIZE
	(l x w x h mm)
6091301	10 x 18 x 35
6091302	10 x 18 x 35
6091303	7 x 18 x 35



Stainless Steel Bird Nest Nozzle 特殊花嘴



CODE	SIZE
	(Ø x h cm)
6094001	25 x 40



6093901 6093902 6093903

Stainless Steel Cream Puff Tube 特殊花嘴



CODE	SIZE
	(Ø x h mm)
6093901	Ø 6.0 x 65
6093902	Ø 4.0 x 93
6093903	Ø 7.5 x 94



Stainless Steel "SULTANE" Nozzle 手工花嘴



CODE	SIZE
	(l x w x h mm)
6091201	25 x 42 x 48



Stainless Steel "YULE" Log Nozzle 半排手工花嘴



CODE	SIZE
	(l x w x h mm)
6091401	15 x 25 x 40
6091402	18 x 24 x 42
6091403	18 x 30 x 45



Piping Nozzle Tube Brush 花嘴刷



CODE	SIZE
	(l mm)
6091501	

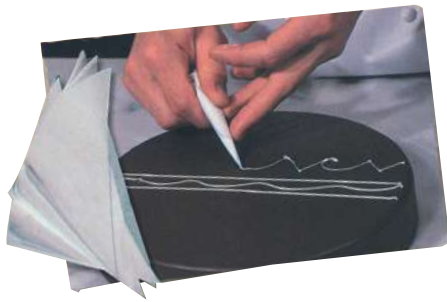

Greaseproof Paper Cone for Writing
防油紙盆



CODE	SIZE (w x h cm)	REMARKS
6092101	20 x 32	2000pcs/pkt



Disposable Polyethylene Pastry Piping Bag
一次性聚乙烯擠花袋



CODE	SIZE (l cm)	SPEC
6091750	50	100 pcs/box
6091755	55	100 pcs/box



PP Piping Bag Holder
擠花袋座



CODE
6091901



Disposable Pastry Piping Bag
塑膠擠花袋



CODE	SIZE (l x w) (inch)	REMARKS
6091616	40.6 x 21 16	100pcs/box
6091618	45.0 x 24.8 18	100pcs/box



Nylon Piping Bag
擠花袋



CODE	SIZE (l cm)	CODE	SIZE (l cm)
6091825	25	6091850	50
6091828	28	6091855	55
6091834	34	6091865	65
6091840	40	6091870	70
6091846	46		



Piping Bag Dryer Wall Rack
擠花袋晾乾架



CODE	SIZE (l cm)
6092001	59.2 x 50 x 35.3



**Stainless Steel Automatic
Piston Funnel + Stand**
不锈钢自动漏斗器+架



CODE	SIZE (l x w x h cm)	CAP (L)
2200108	15.5 x 18.5 x 15	0.8



**Stainless Steel Portion
Cream Filler Pump**
充填機

CODE	SIZE (l cm)	CAP (Ltr)
6092201	50 x 50.4	5



**Stainless Steel Automatic
Piston Funnel & Stand**
不锈钢自动漏斗器



CODE	SIZE (Ø cm)	CAP (lit)
2200533	20	3.3



**Stainless Steel Automatic
Piston Funnel & Stand**
不锈钢自动漏斗器



CODE	SIZE (Ø cm)	CAP (lit)
2200319	19.0	1.9
2200415	17.5	1.5

Steel

2200215	15
---------	----



Large Cream Filling Pump
大型充填機



CODE	CAP (L)
6092301	7



Aluminium Pizza Peel
木柄铝比萨铲

CODE	BLADE SIZE (l x w cm)	HANDLE LENGTH (cm)
6092401	30.5 x 30.5	90.0
6092402	40 x 40	138.0



Wooden Pizza Peel
木比萨铲

CODE	SIZE (l x w cm)	HANDLE LENGTH (cm)
6092501	30.5 x 35.5	20.3
6092502	30.5 x 35.5	43



Stainless Steel Pizza Peel
不锈钢比萨铲

CODE	BLADE SIZE (l x w cm)
6092622	22 x 18.5



Stainless Steel Pizza Peel
不锈钢长比萨铲

PIAZA

CODE	SIZE (Ø cm)	HANDLE LENGTH (cm)	REMARKS
6092618	18	178	Perforated
6092633	33	192	



Stainless Steel Pizza Cutter
(Plastic Handle)
不锈钢比萨刀 (胶柄)

CODE	SIZE (Ø cm)
2362410	10



Stainless Steel Pizza Cutter
(Wooden Handle)
不锈钢比萨刀 (木柄)

CODE	SIZE (Ø cm)
2362411	10



Stainless Steel Pizza Pan Gripper
不锈钢比萨锅夹

CODE	SIZE (l cm) (inch)
6092708	20.3 8



Nickel Plated Pizza Pan Gripper
比萨锅夹

CODE	SIZE (l cm) (inch)
6092808	20.3 8



Oven Mitten Glove

耐热手套



Up to 204°C

Heavy Duty

CODE	SIZE	
	(l cm)	(inch)
6093113	35	15
6093117	43	17

Economy

CODE	SIZE	
	(l cm)	(inch)
6093213	33	13
6093217	43	17

Heavy Duty Extra Long

CODE	SIZE	
	(l cm)	(inch)
6093415	38.1	15
6093424	60.9	24



Oven / Flame Guard Mittens Glove

(Extra Duty)

耐热手套

CODE	SIZE	
	(l cm)	(inch)
6093315	38	15



Up to 250°C

Baker Gloves, kidleter

耐热手套

CODE	SIZE
	(l cm)
6093501	

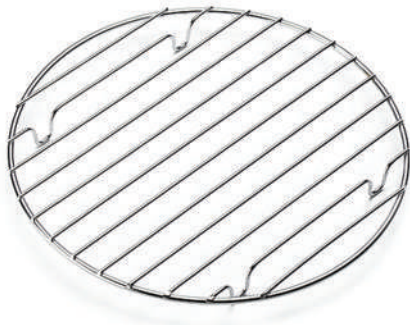

Round Cooling Rack
条状有脚圆烧烤网 (钢, 长方洞)

CODE	SIZE	
	(Ø cm)	(inch)
6100110	25.5	10
6100112	30.5	12
6100113	33.0	13
6100114	35.5	14
6100115	38.0	15

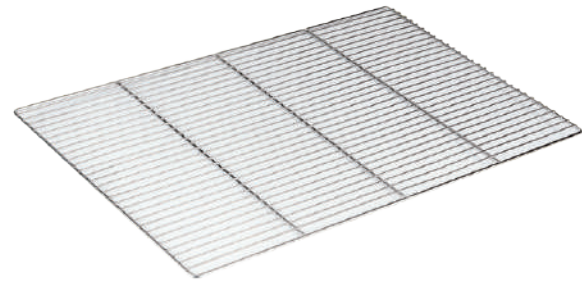

Flat Stainless Steel Grill Rack
不锈钢烘烤网

CODE	SIZE (l x w cm)	SIZE INDICATOR
2030111	32 x 53	Fits: 1 / 1
2030121	53 x 65	Fits : 2 / 1
2030146	40 x 60	Fits : 40 x 60



Footed Stainless Steel Grill Rack
带脚不锈钢烘烤网

CODE	SIZE (l x w cm)	SIZE INDICATOR
2030211	32 x 53	Fits: 1 / 1
2030221	53 x 65	Fits : 2 / 1
2030246	40 x 60	Fits : 40 x 60



Footed Chrome Grill Rack
有脚放盆内网

CODE	SIZE (l x w cm)	SIZE INDICATOR
6100201	60.96 x 40.60	Fit: 40 x 60" Sheet Pan
1160121	63.50 x 43.18	Fit: 18 x 26" Sheet Pan

Square Tube Screen Grate
方形烘烤网

CODE	SIZE (l x w cm)
6100399	24.0 x 24.0
6100311	29.8 x 29.8
6100313	34.9 x 34.9
6100317	44.4 x 44.4

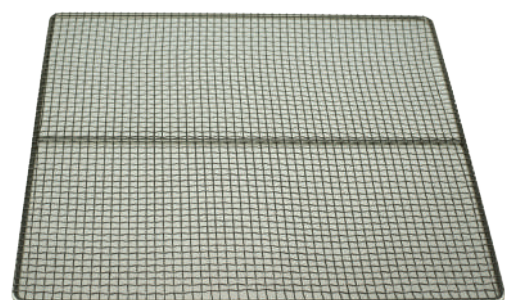



Aluminium Round Pizza Tray
铝圆形比萨盘

CODE	SIZE	
	(Ø cm)	(inch)
6100409	22.8	9
6100410	25.4	10
6100411	27.9	11
6100412	30.5	12
6100414	35.5	14



Blue Steel Round Pizza Tray
圆形比萨盘



CODE	SIZE	
	(Ø cm)	
6100520	20	
6100524	24	
6100526	26	
6100528	28	
6100532	32	



Blue Steel Round Pizza Tray
圆形有洞比萨盘



CODE	SIZE	
	(Ø cm)	
6100624	24	
6100628	28	
6100632	32	



Round Aluminium Pizza Screen
圆铝比萨盘

CODE	SIZE	
	(Ø cm)	(inch)
6100709	22.8	9
6100710	25.4	10
6100712	27.9	11
6100713	30.5	12
6100714	35.5	14

Baking Tray, Embossed Pan (Roll Edge)

长方形铝托盘 (滚边)

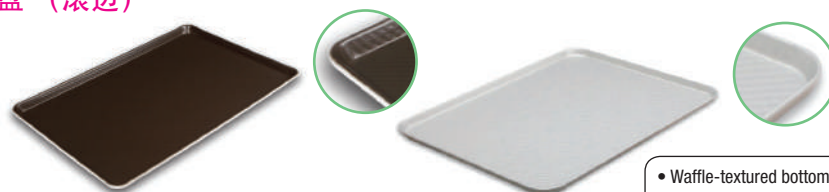

- Waffle-textured bottom increase strength.
- Easier for de-mould.
- Reducing baking time.

60x40x2 cm Height

CODE	SIZE (l x w x h cm)	THICKNESS	TYPE	REMARKS
2020101	60 x 40 x 2.0	1.2	Non-Stick 不粘	SN1318
2020201	60 x 40 x 2.0	1.2	Standard 铝合金	SN1330

40x30x1.2 cm Height

CODE	SIZE (l x w x h cm)	THICKNESS	TYPE	REMARKS
2020102	40 x 30 x 1.2	1.2	Non-Stick 不粘	SN1314
2020202	40 x 30 x 1.2	1.2	Standard 铝合金	SN1313

Aluminium Baking Tray (Angled Edge)

长方形铝托盘



60x40x3 cm Height

CODE	SIZE (l x w x h cm)	THICKNESS	TYPE	REMARKS
2020500	60 x 40 x 3	0.7	Non-Stick 不粘	SN1072
2020600	60 x 40 x 3	0.7	Standard 铝合金	SN1071

Baking Tray, Al. Steel Plate

长方形铝托盘



60x40x3 cm Height

CODE	SIZE (l x w x h cm)	THICKNESS	TYPE	REMARKS
2020800	60 x 40 x 3	0.7	Non-Stick 不粘	SN1078
2020700	60 x 40 x 3	0.7	Standard 铝合金	SN1077

60x40x5 cm Height

CODE	SIZE (l x w x h cm)	THICKNESS	TYPE	REMARKS
2021201	60 x 40 x 5	0.7	Non-Stick 不粘	SN1080
2021301	60 x 40 x 5	0.7	Standard 铝合金	SN1079

67.5x43.5x2.5 cm Height

CODE	SIZE (l x w x h cm)	THICKNESS	TYPE	REMARKS
2020801	67.5 x 43.5 x 2.5	0.7	Non-Stick 不粘	SN1030
2020701	67.5 x 43.5 x 2.5	0.7	Standard 铝合金	SN1036



Baking Tray. Al. Steel Plate 长方形铝托盘



71.8x46x2.5 cm Height

CODE	SIZE (l x w x h cm)	THICKNESS	TYPE	REMARKS
6101500	71.8 x 46.0 x 2.5	0.7	Non-Stick 不粘	SN1010
6101200	71.8 x 46.0 x 2.5	0.7	Standard 铝合金	SN1017

71.8x46x5 cm Height

CODE	SIZE (l x w x h cm)	THICKNESS	TYPE	REMARKS
6101600	71.8 x 46.0 x 5.0	0.7	Non-Stick 不粘	SN1018
6101300	71.8 x 46.0 x 5.0	0.7	Standard 铝合金	SN1013



3 mm hole

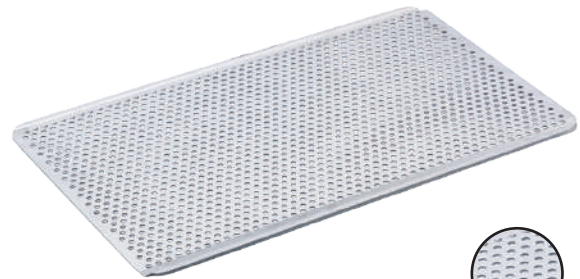
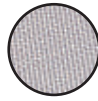

8 mm hole

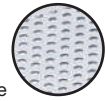

Perforated Aluminium Baking Tray 有洞长方形铝托盘



CODE	SIZE (l x w x h cm)	THICKNESS	REMARKS
2020900	60 x 40 x 2	1.2 mm	SN1073

Perforated Aluminium Flat Tray 有洞长方形铝托盘



CODE	SIZE (l x w x h cm)	THICKNESS	REMARKS
6101100	60 x 40	1.5 mm	SN1564



American Size Aluminium Sheet Pan 铝托盘

CODE	SIZE (l x w x h cm)	SIZE (Inch)	TYPE
2021113	24 x 33 x 2.5	9.5 x 13 x 1	Quarter
2021112	45 x 33 x 2.5	18 x 13 x 1	Half
2021111	65 x 45 x 2.5	26 x 18 x 1	Full



Vollrath's Wear-Ever®
smooth edge corner

Competitor's
crimped
edge corner

- impact-resistant 3004 aluminium.
- tapered design for easy stacking.
- sized to fit standard baker's racks.
- closed bead includes galvanized non-rusting rod for reinforcements.
- concave bottoms flatten during heating for even heat distribution.



1.2 mm thickness

Blue Steel Baking Tray (Straight Edge) 铁烤盘



CODE	SIZE (l x w x h cm)	TYPE
2030453	53.0 x 32.5 x 1	1 / 1
2030465	65.0 x 53.0 x 1	2 / 1
2030440	40.0 x 30.0 x 1	40 x 30
2030460	60.0 x 40.0 x 1	60 x 40



1.2 mm thickness

Blue Steel Baking Tray (Oblique Edge) 铁烤盘



CODE	SIZE (l x w x h cm)	TYPE
6102053	53.0 x 32.5 x 1	1 / 1
6102065	65.0 x 53.0 x 1	2 / 1
6102040	40.0 x 30.0 x 1	40 x 30
6102060	60.0 x 40.0 x 1	60 x 40



1 mm thickness

Stainless Steel Baking Tray (Oblique Edge) 钢烤盘



CODE	SIZE (l x w x h cm)	TYPE
2030353	53.0 x 32.5 x 1	1 / 1
2030365	65.0 x 53.0 x 1	2 / 1
2030360	60.0 x 40.0 x 1	60 x 40



1.5 mm thickness

Aluminium Perforated Tray (Oblique Edge) 带洞烤盘



CODE	SIZE (l x w x h cm)	TYPE
2030653	53.0 x 32.5 x 1	1 / 1
2030660	60.0 x 40.0 x 1	60 x 40
2030640	40.0 x 30.0 x 1	40 x 30

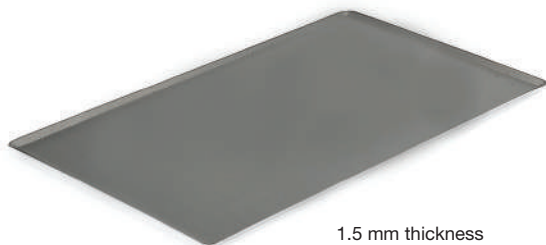

1.5 mm thickness

Aluminium Non-Stick Baking Tray (Oblique Edge) 不粘烤盘 (铝合金)



CODE	SIZE (l x w x h cm)	TYPE
2030753	53.0 x 32.5 x 1	1 / 1
2030765	65.0 x 53.0 x 1	2 / 1
2030740	40.0 x 30.0 x 1	40 x 30
2030760	60.0 x 40.0 x 1	60 x 40



1.5 mm thickness

Aluminium Baking Tray (Oblique Edge) 铝烤盘



CODE	SIZE (l x w x h cm)	TYPE
2030553	53.0 x 32.5 x 1	1 / 1
2030560	60.0 x 40.0 x 1	60 x 40
2030540	40.0 x 30.0 x 1	40 x 30



Non-Stick Round Burger Bun Tray 15连深汉堡烤盘 (不沾)



CODE	SIZE (l x w x h mm)	REMARKS
6102815	675 x 435 x 50	SN1624

Non-Stick Hot Dog Bun Tray 14连长条麵包烤盘 (不沾)



CODE	SIZE (l x w x h cm)	REMARKS
6102914	67.5 x 43.5 x 4	SN1641

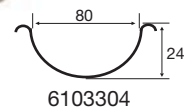
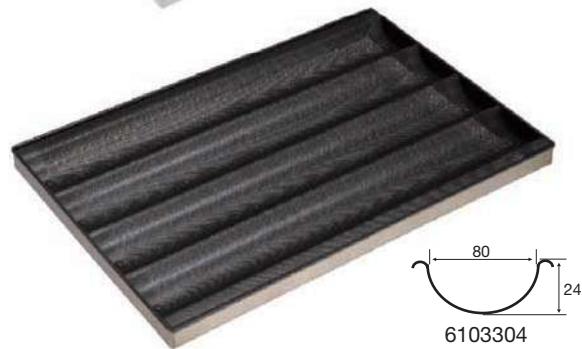
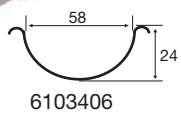
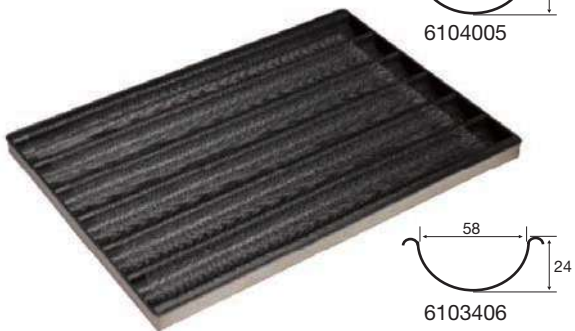
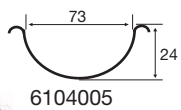
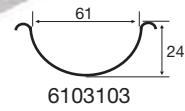
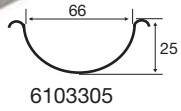

Non-Stick French Bread Baking Tray 五/六槽法國烤盤(不沾)



CODE	SIZE (l x w x h cm)	REMARKS
6103305	60 x 40 x 3.3	5 Row SN1595
6103405	66 x 46 x 3.3	5 Row SN1593
6103406	66 x 46 x 3.0	6 Row SN1592

Non-Stick French Bread Baking Tray 三/四槽法國烤盤 (不沾)



CODE	SIZE (l x w x h cm)	REMARKS
6103103	36.5 x 26.5 x 3.5	3 Row SN1591
6103304	60.0 x 40.0 x 3.3	4 Row SN1594



Silicon Baking Mat
硅胶烘焙垫



CODE	SIZE (l x w cm)	SPEC (cm)
6103600	51.0 x 31.0	Fits GN 1/1 Baking Pan
6103601	29.0 x 21.0	Fits 30 x 40 Baking Pan
6103602	58.5 x 38.5	Fits 40 x 60 Baking Pan
6103603	62.0 x 42.0	Fits 18" x 26" American Sheet Pan



Orange Silicon Baking Mat
硅胶烘焙垫



CODE	SIZE (l x w cm)	SPEC (cm)
6103701	52 x 31	Fits GN 1 / 1 Baking Pan
6103702	39 x 29	Fits 30 x 40 Baking Pan
6103703	58 x 38	Fits 40 x 60 Baking Pan
6103704	62 x 42	Fits 18" x 26" American Sheet Pan



Fibre Glass Baking Sheet
不沾布



CODE	SIZE (l x w cm)	SPEC (cm)	REMARKS
6103900	58 x 38	Fits 40 x 60 Baking Pan	10 pcs / pkt



Non-Stick Baking Paper In Roll
不粘烘焙纸

CODE	SIZE (w x l)
6103800	18" x 100 m

Aluminium Muffin Pan
铝松饼盘

CODE	SIZE (l x w x h cm)	SPEC
6110112	27.3 x 35.9 x 2.5	12 Cups, Plain
6110124	52.4 x 35.9 x 2.5	24 Cups, Plain
6110212	27.3 x 35.9 x 2.5	12 Cups, Non-Stick
6110224	52.4 x 35.9 x 2.5	24 Cups, Non-Stick





Round Dough Basket

圓形面包籃



CODE	SIZE (Ø x h cm)	Weight
6110400	21 x 9	500g
6110401	24 x 10	1000g
6110402	27 x 11	1500g
6110403	29 x 12	2000g
6110404	31 x 12.5	2500g
6110405	33 x 13	3000g

Round Dough Basket in a Ring

圓形面包籃



CODE	SIZE (Ø x h cm)	weight
6110500	26 x 7.0	500g
6110501	30 x 7.5	750g
6110502	33 x 8.0	1000g

Country Bread Basket

橢圓形面包籃



CODE	SIZE (Ø x h cm)	weight	
6110620	20 x 14	500g	Oval
6110624	24 x 14	750g	Oval
6110627	26	2000g	Round
6110628	19	500g	Round



Pizza Dough Box

比萨饼面团存储箱



Polycarbonate
比萨饼面团存储箱



CODE	SIZE (l x w x h Inch)	REMARKS
6110703	26 x 18 x 3	DB18263CW
6110706	26 x 18 x 6	DB18266CW

Cover For Dough Box

盖子

CODE	SIZE (l x w Inch)	REMARKS
6110800	26 x 18	DBC1826CW

Colour: White



Polypropylene
比萨饼面团存储箱



CODE	SIZE (l x w x h Inch)	REMARKS
6113903	26 x 18 x 3	DB18263P

Cover For Dough Box

盖子

CODE	SIZE (l x w Inch)	REMARKS
6114000	26 x 18	DBC1826P

Colour: White



Hold 136kg

Pizza Dough Camdolly
比萨饼面团存储箱小车



CODE	SIZE (l x w x h Inch)	REMARKS
6110900	19.78" x 27.78" x 10.14"	CD1826PDB-401

Colour: Slate Blue



Ingredient Bin, Flat Lid
食品原料箱



CODE	SIZE (w x d x h cm)	CAP (L / Gal)	REMARKS
9012036	39 x 75 x 74.0	129 / 34	IB36
9012044	47 x 75 x 74.0	161 / 42.5	IB44



Ingredient Bins SLANT Lid
食品原料箱



CODE	SIZE (w x d x h cm)	CAP (L / Gal)	REMARKS
9011921	33 x 75 x 71	81 / 21	IBS20
9011927	42 x 75 x 71	102 / 27	IBS27
9011937	55 x 75 x 71	140 / 37	IBS37

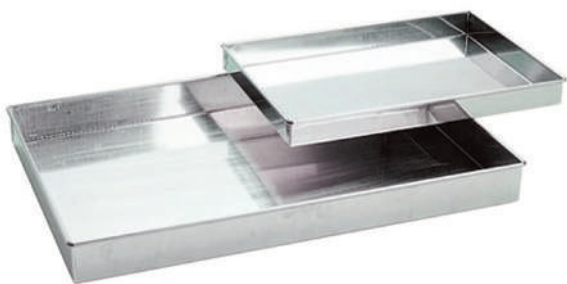

Tinplated Cake Roll Pan
镀锡盘

CODE	SIZE (l x w x h cm)
6115030	30 x 20 x 3.5
6115040	40 x 30 x 3.5
6115050	50 x 35 x 5.0
6115060	60 x 40 x 5.0



Tinplated Cake Roll Pin
镀锡棒

CODE	SIZE (l x w x h cm)
6112350	50 x 12 x 3.4
6112360	60 x 12 x 3.4



Tinplated Rectangle Pate Mould, Ridges
镀锡长方形模具

CODE	SIZE (l x w x h cm)
6115525	25 x 6.5 x 7.5
6115530	30 x 7.0 x 8.0
6115535	35 x 7.5 x 8.5
6115540	40 x 7.5 x 8.5



Rectangular Pate Mould, Plain, Tinplate
长方形模具

CODE	SIZE (l x w x h cm)
6112525	30 x 7.0 x 8.0
6112530	25 x 6.5 x 7.5
6112535	35 x 7.5 x 8.5
6112540	40 x 7.5 x 8.5



Tinplated Yule Log Mould
镀锡圣诞节原木模具

CODE	SIZE (l x w x h cm)
6115235	35 x 8 x 5.5

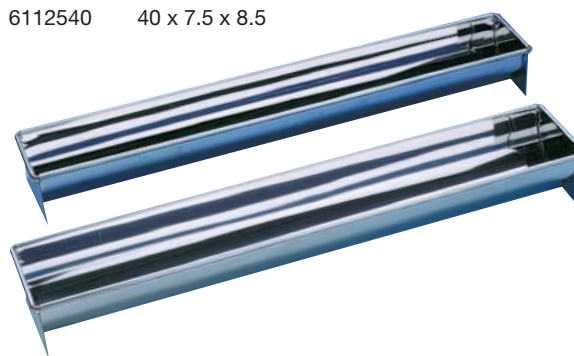

Stainless Steel Yule Log Mould
不锈钢圣诞节原木模具

CODE	SIZE (l x w x h cm)
6112250	50 x 8 x 5.5

Set of 4 Combs For Yule Logs
圣诞节原木模梳子

CODE	SPEC
6112200	Suitable for round gutters 8 cm wide, allows the production of logs in several flavors (based on foam or ice)

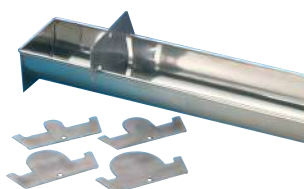



**Stainless Steel Dent-De-Loop
Biscuits Sheet**
不锈钢烤盘

CODE	SIZE (l x w cm)
6115301	35 x 29



Stainless Steel Tuiles Sheet
不锈钢烤盘

CODE	SIZE (l x w cm)
6115401	35 x 32

Blue Steel



Covered Bread Pan
有盖面包盘

CODE	SIZE (l x w cm)	weight
6111825	25 x 9	500g
6111827	27 x 10	800g
6111829	29 x 11	1000g

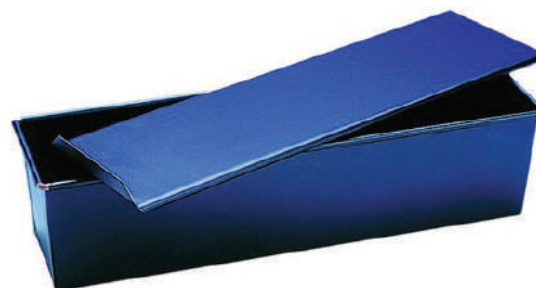

Large Bread Pan
面包盘

CODE	SIZE (l x w x h cm)
6114595	40 x 10 x 10
6114596	40 x 12 x 12



Loaf Pan
面包盘

CODE	SIZE (l x w x h cm)
6111730	30 x 8 x 8
6111740	40 x 8 x 8
6111750	50 x 8 x 8



Bread Loaf
面包盘

CODE	SIZE (l x w x h cm)	CODE	SIZE (l x w x h cm)
6114320	20 x 9.5 x 8	6114335	35 x 9.5 x 8
6114325	25 x 9.5 x 8	6114340	40 x 9.5 x 8
6114330	30 x 9.5 x 8		

Blue Steel



Wide Loaf Pan

面包盘

CODE	SIZE (l cm)
6114740	40 x 10 x 8
6114750	50 x 10 x 8

Non-Stick Coating



Yule Log Mould

圣诞节原木模具

CODE	SIZE (l x w x h cm)
6112435	35 x 8 x 5.5
6112450	50 x 8 x 5.5

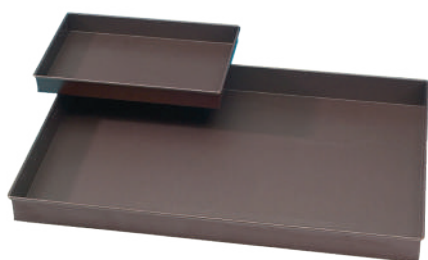

Cake Roll Pan

镀锡盘

CODE	SIZE (l x w x h cm)
6115830	30 x 20 x 3.5
6115840	40 x 30 x 3.5
6115850	50 x 35 x 5.0
6115860	60 x 40 x 5.0

Small Round Bread Mould

面包盘

CODE	SIZE (l cm)
6114400	30 x 5

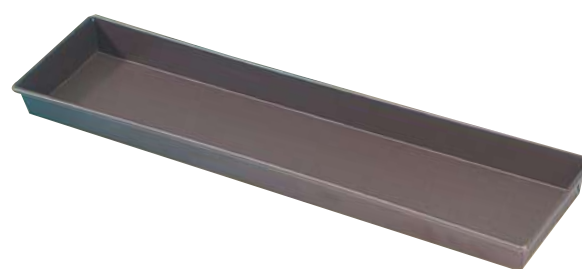

Cake Roll Pan

蛋糕盘

CODE	SIZE (l x w x h cm)
6112150	50 x 12 x 3.4
6112160	60 x 12 x 3.4



Mini Pate Plain Mould

小长方形模具

CODE	SIZE (l x w cm)
6112750	50 x 6 x 6

Non-Stick Coating



Pate Mould with Ridges 长方形模具

CODE	SIZE (l x w x h cm)
6112630	30 x 8.0 x 5.0
6112635	30 x 8.5 x 8.5
6112640	40 x 8.5 x 8.5



Loaf Pan 面包盘

CODE	SIZE (l x w x h cm)
6114818	18 x 8 x 8
6114820	20 x 8 x 8
6114822	22 x 8 x 8



Wide Loaf Pan 面包盘

CODE	SIZE (l x w x h cm)
6114940	40 x 10 x 8
6114950	50 x 10 x 8



20 Madeleines Sheet 20连海面糕模

CODE	SIZE (l x w cm)
6113720	35.8 x 19.7



Loaf Pan 面包盘

CODE	SIZE (l x w x h cm)
6112925	25 x 9.5 x 48
6112930	30 x 9.5 x 48
6112935	35 x 9.5 x 48
6112940	40 x 9.5 x 48



Bread Mould 面包模

CODE	SIZE (l x w x h cm)
6111925	25 x 8 x 8
6111930	30 x 8 x 8
6111935	35 x 8 x 8
6111940	40 x 8 x 8



Bread Pan With Cover 有盖面包盘

CODE	SIZE (l x w x h cm)	SPEC (g)
6112025	25 x 9	500
6112027	27 x 10	800
6112029	29 x 11	1000



12 Madeleines Sheet 12连海面糕模

CODE	SIZE (l x w cm)
6113712	35.8 x 19.7

Non-Stick Coating



Kugelhopf Mould
菊花模

CODE	SIZE (Ø x h cm)
6122716	16 x 7
6122720	20 x 10
6122724	24 x 12



"TROIS FRERES" Ring Mould
菊花模

CODE	SIZE (Ø x h cm)
6122816	16 x 4.5
6122820	20 x 4.0
6122822	22 x 4.0



Deep Plain Cake Pan
深圆形蛋糕盘

CODE	SIZE (Ø x h cm)	CODE	SIZE (Ø x h cm)
6122210	10 x 3.0	6122222	22 x 4.2
6122212	12 x 3.2	6122224	24 x 4.2
6122214	14 x 3.5	6122226	26 x 4.5
6122216	16 x 3.7	6122228	28 x 4.5
6122218	18 x 4.0	6122230	30 x 4.7
6122220	20 x 4.0		



Plain Tart Mould
圆形派盘

CODE	SIZE (Ø x h cm)	CODE	SIZE (Ø x h cm)
6122312	12 x 2.1	6122322	22 x 2.3
6122314	14 x 2.2	6122324	24 x 2.3
6122316	16 x 2.2	6122326	26 x 2.3
6122318	18 x 2.3	6122328	28 x 2.3
6122320	20 x 2.3	6122330	30 x 2.5



Fluted Tart Mould
圆形菊花派盘

CODE	SIZE (Ø x h cm)	CODE	SIZE (Ø x h cm)
6122416	16 x 2.0	6122424	24 x 2.5
6122418	18 x 2.2	6122426	26 x 2.5
6122420	20 x 2.5	6122428	28 x 2.5
6122422	22 x 2.5	6122430	30 x 2.5



Fluted Fruit Tart Mould
圆形水果菊花派盘

CODE	SIZE (Ø x h cm)
6122520	20 x 2.5
6122524	24 x 2.5
6122526	26 x 2.5
6122528	28 x 2.5

Fluted Tart Mould (Removable Bottom)
活底水果菊花派盘

CODE	SIZE (Ø x h cm)	CODE	SIZE (Ø x h cm)
6122620	20 x 2.5	6122626	26 x 2.5
6122622	22 x 2.5	6122628	28 x 2.5
6122624	24 x 2.5	6122630	30 x 2.5





Non-Stick Mini Square Loaf Pan
土司盒 (不沾)



CODE	SIZE (l x w x h cm)	SPEC (mm)	REMARKS
6111000	11.5 x 11.5 x 11.5	1 mm, Thick	SN2050



Aluminium Loaf Pan (Body)
土司盒



CODE	SIZE (l x w x h cm)	SPEC (cm)	REMARKS
6111200	19.7 x 10.6 x 11	450g, Plain	SN2051
6111300	19.7 x 10.6 x 11	450g, Non-Stick	SN2052

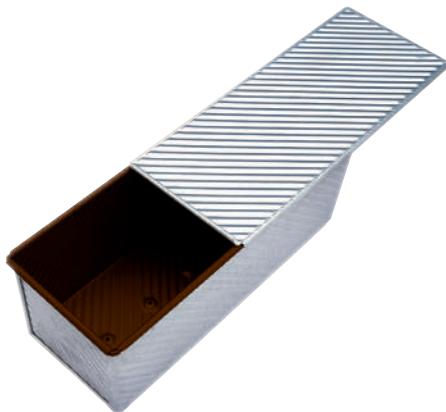

Non Stick Aluminium Corrugated Loaf Pan
波纹土司盒(不沾)



CODE	SIZE (l x w x h cm)	WEIGHT (g)	REMARKS
6114109	32.7 x 10.6 x 12.2	900g	SN2025
6114110	32.7 x 12.1 x 12.1	1000g	SN2015
6114112	37.0 x 12.0 x 12.5	1200g	SN2007

Non-Stick Loaf Pan Cover
土司盒-蓋(不沾)

CODE	SIZE (l x w x h cm)	SPEC (g, mm)
6111201	21.0 x 12.2 x 7	450g



Non-Stick Aluminium Loaf Pan with Lid
波纹土司盒 (不沾)



CODE	SIZE (l x w x h cm)	WEIGHT (g)	REMARKS
6111106	30.9 x 9.1 x 10.7	600g	SN2042
6111109	32.7 x 10.6 x 12.2	900g	SN2022
6111110	32.7 x 12.1 x 12.1	1000g	SN2012
6111112	37.0 x 12.0 x 12.5	1200g	SN2004



Non-Stick Rectangular Aluminium Loaf / Cake Pan
土司盒(不沾)



CODE	SIZE (l x w x h cm)	REMARKS
6114220	17.5 x 8.5 x 7.0	SN2120
6114225	24.0 x 7.7 x 6.2	SN2125
6114226	21.0 x 7.7 x 6.3	SN2126



Non-Stick Loaf Pan
3连土司盒 (不沾)



CODE	SIZE (l x w x h cm)	SPEC (g)	REMARKS
6111500	50.5 x 38.3 x 12.8	1200g / 3 Straps	SN2911



Non-Stick Round Loaf Pan, Stripped
圆土司 (不沾)



CODE	SIZE (l x w x h cm)	WEIGHT (g)	REMARKS
6114600	28.7 x 8.3	380g	SN2303



Non-Stick Round Loaf Pan, Wavy
波纹圆土司 (不沾)



CODE	SIZE (l x w x h cm)	WEIGHT (g)	REMARKS
6114601	27 x 18.3 x 12.8	600g	SN2305



Non-Stick Cake Pan (Silicone)
土司盒 (不沾)



CODE	SIZE (l x w x h cm)	REMARKS
6111400	15.1 x 6.7 x 6.7 / 14.2 x 5.8	SN2174



Cake Pan (Body)
蛋糕盘



CODE	SIZE (l x w x h cm)	REMARKS
6111604	10.0 x 5.6 x 3.5	SN2073
6111605	12.8 x 6.6 x 4.0	SN2072



Aluminium Terrine Mould
三角慕斯模



CODE	SIZE (l x w x h cm)	SPEC
6112970	36.4 x 6 x 4.6	Half Sphere
6112971	36.4 x 6 x 4.6	Triangle
6112972	36.4 x 6 x 4.6	Groove
6112973	36.4 x 6 x 4.6	Double Groove



Fluted Tart Mould
合金菊花派盘



CODE	SIZE		REMARKS
	(l x w x h cm)	(inch)	
6123510	10 x 8.2 x 2.1	4	SN5431
6123516	16 x 14.3 x 2.3	6	SN5432
6123520	20 x 18.1 x 2.6	8	SN5433
6123524	24 x 22.1 x 2.6	9	SN5434



Fluted Tart Mould (Removable Bottom)
活底合金菊花派盘



CODE	SIZE		REMARKS
	(l x w x h cm)	(inch)	
6123616	16 x 14.3 x 2.3	6	SN5440
6123620	20 x 18.1 x 2.6	8	SN5441
6163624	24 x 22.1 x 2.6	9	SN5442



Hard Anodized Fluted Tart Mould
合金菊花派盘



CODE	SIZE		REMARKS
	(td x bd x ht cm)		
6123016	16 x 14.3 x 2.3	SN5552	
6123020	20 x 18.1 x 2.6	SN5553	
6123024	24 x 22.1 x 2.6	SN5554	



Hard Anodized Fluted Tart Mould
活底合金菊花派盘



CODE	SIZE		REMARKS
	(td x bd x ht cm)		
6123116	16 x 14.3 x 2.3	SN5560	
6123120	20 x 18.1 x 2.6	SN5561	
6123124	24 x 22.1 x 2.6	SN5562	



Hard Anodized Fluted Tart Mould
合金菊花派盘



CODE	SIZE		TYPE	REMARKS
	(l x w x h cm)			
6123725	25.0 x 10.0 x 2.5	Rectangle	SN5574	
6123721	21.0 x 21.0 x 2.5	Square	SN5577	





Hard Anodized Pizza / Pie Pan
披萨盘



CODE	SIZE		REMARKS
	(td x bd x ht cm)	(inch)	
6123206	15.2 x 12.7 x 1.6	6	SN5722
6123207	17.8 x 15.2 x 1.7	7	SN5723
6123208	20.3 x 17.8 x 1.7	8	SN5724
6123209	22.9 x 20.3 x 1.8	9	SN5725
6123210	25.4 x 22.9 x 1.8	10	SN5726
6123211	27.9 x 25.4 x 1.9	11	SN5727
6123212	30.5 x 27.9 x 1.9	12	SN5728



Hard Anodized Deep Pizza Pan
披萨盘



CODE	SIZE		REMARKS
	(td x bd x ht cm)	(inch)	
6123406	15.2 x 14.0 x 4.1	6	SN5762
6123407	17.8 x 16.6 x 4.1	7	SN5763
6123408	20.3 x 19.7 x 4.1	8	SN5764
6123409	22.9 x 21.3 x 4.1	9	SN5765
6123410	25.4 x 23.3 x 4.1	10	SN5766
6123412	30.5 x 28.9 x 4.1	12	SN5768



Hard Anodized Pizza Pan
披萨盘



CODE	SIZE		REMARKS
	(td x bd x ht cm)	(inch)	
6123306	15.2 x 14.2 x 2.4	6	SN5742
6123307	17.8 x 16.8 x 2.4	7	SN5743
6123308	20.3 x 19.3 x 2.5	8	SN5744
6123309	22.9 x 21.9 x 2.5	9	SN5745



Hard Anodized Deep Cake Pan
固定蛋糕模 (硬膜)



CODE	SIZE		CODE	SIZE
	(td x bd x ht cm)	(inch)		
6113106	15.2 x 14.7 x 7.0	6	6113110	25.4 x 24.8 x 7.9
6113107	17.8 x 17.2 x 7.5	7	6113112	30.5 x 29.9 x 8.0
6113108	20.3 x 19.7 x 7.5	8	6113114	35.6 x 34.5 x 8.0
6113109	22.9 x 22.3 x 7.5	9		

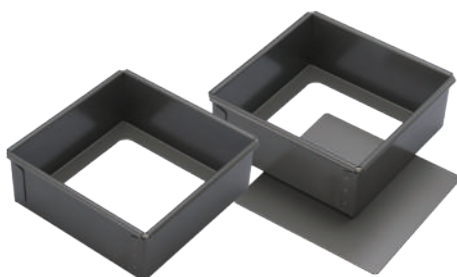

Hard Anodized Square Cake Pan
(Removable Bottom)
活动方形蛋糕模



CODE	SIZE		REMARKS
	(l x w x h cm)	(inch)	
6115608	14.5 x 14.5 x 6.0	8	
6115610	18.0 x 18.0 x 6.0	10	
6115612	21.5 x 21.5 x 6.0	12	



Hard Anodized Deep Cake Pan
(Removable Bottom)
活动蛋糕模



CODE	SIZE		CODE	SIZE
	(td x bd x ht cm)	(inch)		
6113206	15.2 x 14.8 x 6.9	6	6113210	25.4 x 24.8 x 7.9
6113207	17.8 x 17.2 x 7.4	7	6113212	30.5 x 30.0 x 8.0
6113208	20.3 x 19.7 x 7.4	8	6113214	35.6 x 34.5 x 7.9
6113209	22.9 x 22.3 x 7.4	9		

Aluminium Mould



Deep Round Cake Mould 凸點固定蛋糕模



CODE	SIZE		
	(td x bd x ht cm)	(inch)	
6113304	10.2 x 10.0 x 6.0	4	
6113305	12.7 x 10.6 x 6.0	5	
6113306	15.2 x 14.7 x 6.9	6	Anti Jam
6113307	17.8 x 17.2 x 7.5	7	Anti Jam
6113308	20.3 x 19.7 x 7.5	8	Anti Jam
6113309	22.9 x 22.3 x 7.5	9	Anti Jam
6113310	25.4 x 24.8 x 7.9	10	Anti Jam
6113312	30.5 x 30.0 x 7.9	12	Anti Jam
6113314	35.6 x 34.5 x 8.0	14	Anti Jam

Deep Round Cake Mould (Removable Bottom) 活动蛋糕模



CODE	SIZE		
	(td x bd x ht cm)	(inch)	
6113004	10.2 x 10.0 x 6	4	
6113005	12.7 x 10.6 x 6	5	
6113006	15.2 x 14.8 x 6.9	6	Anti Jam
6113007	17.8 x 17.2 x 7.4	7	Anti Jam
6113008	20.3 x 19.7 x 7.4	8	Anti Jam
6113009	22.9 x 22.3 x 7.4	9	Anti Jam
6113010	25.4 x 24.8 x 7.9	10	Anti Jam
6113012	30.5 x 30.0 x 8.0	11	Anti Jam
6113014	35.6 x 34.5 x 7.9	12	Anti Jam



Non-Stick Square Cake Pan 方形蛋糕模(不沾)



CODE	SIZE		
	(l x w x h cm)	(inch)	
6115708	14.5 x 14.5 x 6.0	8	
6115710	18.0 x 18.0 x 6.0	10	
6115712	21.5 x 21.5 x 6.0	12	



Aluminium Cheese Cake Mould 乳酪蛋糕模



CODE	SIZE (l x w x h cm)	REMARK	
		6166600	21.4 x 10 x 5.5
6166601	21.4 x 10 x 5.5	Non-Stick	SN6862



Bundt Form Mould with Tube 浅弯曲空心菊花模



CODE	SIZE (Ø x h cm)	REMARKS
6166200	19 x 4.7	SN6813



Aluminium Trois Freres Mould 浅双层空心菊花模



CODE	SIZE (Ø x h cm)	REMARKS
6166300	18 x 6	SN6820



Aluminium Kugelhupf Mould
 双层空心菊花模



CODE	SIZE (Ø x h cm)	REMARKS
6166400	22 x 11.5	SN6824



Non-Stick Kugelhupf Mould
 双层空心菊花模



CODE	SIZE (Ø x h cm)	REMARKS
6166818	18.0 x 9.5	SN6827
6166822	22.0 x 11.5	SN6828



Heart-Shaped Cake Pan
 (Removable Bottom)
 活动心型模



CODE	SIZE (l x w x h cm)	(inch)
6113844	14.2 x 13.4 x 5.5	6
6113846	18.9 x 17.8 x 6.0	8
6113848	23.6 x 22.2 x 6.7	10



Petit Four Exopan Non-Stick Mould



Square Fluted

CODE	SIZE (w x h cm)	Packing
6120501	3.8 x 3.8	25 pcs / pkt



Deep Boat

CODE	SIZE (l cm)	Packing
6120504	6.5	25 pcs / pkt



Diamond Shape Boat

CODE	SIZE (l cm)	Packing
6120502	6.2	25 pcs / pkt



Fluted Oval

CODE	SIZE (w x h cm)	Packing
6120503	4.7	25 pcs / pkt



Rubbed Dome

CODE	SIZE (l cm)	Packing
6120509	3.5	25 pcs / pkt



Rectangle

CODE	SIZE (l cm)	Packing
6120505	4.9	25 pcs / pkt



Round Deep

CODE	SIZE (l cm)	Packing
6120507	3.5	25 pcs / pkt



Oval Fluted

CODE	SIZE (l cm)	Packing
6120508	4.5	25 pcs / pkt



Plain Diamond / Lozenge

CODE	SIZE (l cm)	Packing
6120506	5.7	25 pcs / pkt



Round Plain

CODE	SIZE (l cm)	Packing
6120510	3.5	25 pcs / pkt



Round Plain

CODE	SIZE (l cm)	Packing
6120511	4.0	25 pcs / pkt



Round Fluted

CODE	SIZE (l cm)	Packing
6120512	4.5	25 pcs / pkt

Box of 60 PETITS FOURS Moulds

CODE	SIZE (l cm)
6120660	



PASTRY



Aluminium Round Baba Mould, Plain
铝制菊花糕模

CODE	SIZE (Ø x h cm)	SPEC
6120104	4 x 4	6 Pcs / Pkt
6120105	5 x 5	6 Pcs / Pkt



Copper Round Fluted Baba Mould
铜制菊花糕模

CODE	SIZE (Ø x h cm)
6120203	3.5 x 3.5
6120204	4.5 x 4.5
6120205	5.5 x 5.0



Stainless Steel Hemispherical Dome
不锈钢半圆穹顶

CODE	SIZE (Ø x h cm)	CAP ltr
6120306	6 x 2.7	0.05
6120307	7 x 3.5	0.08
6120308	8 x 4.0	0.13
6120310	10 x 4.8	0.25
6120312	12 x 5.9	0.45
6120314	14 x 6.7	0.65
6120316	16 x 8.0	1.00
6120318	18 x 8.7	1.46
6120320	20 x 10	2.06

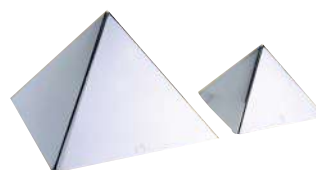

Stainless Steel Pyramid Mould
不锈钢金字塔模

CODE	SIZE (l x w x h cm)	CAP ltr
6120406	6.0 x 6.0 x 4.8	0.05
6120407	7.5 x 7.5 x 5.2	0.09
6120409	9.0 x 9.0 x 6.0	0.16
6120412	12 x 12 x 8.0	0.39
6120415	15 x 15 x 10.0	0.77
6120417	17 x 17 x 12.0	1.15
6120419	19 x 19 x 13.0	1.50

Exopan Non-Stick Mould



Pomponnette
蛋糕模

CODE	SIZE (Ø x h cm)	Packing
6120701	4 x 1.6	25 pcs / pkt
6120703	5 x 2.1	25 pcs / pkt
6120705	6 x 2.3	25 pcs / pkt
6120707	7 x 2.6	25 pcs / pkt



Close Plain Savarin
萨瓦林模

CODE	SIZE (Ø x h cm)	Packing
6120801	5 x 1.2	12 pcs / pkt
6120803	6 x 1.5	12 pcs / pkt
6120805	7 x 1.6	12 pcs / pkt
6120807	8 x 2.0	12 pcs / pkt



Open Plain Savarin
萨瓦林模

CODE	SIZE (Ø x h cm)	Packing
6120901	7 x 1.5	12 pcs / pkt
6120902	8 x 1.8	12 pcs / pkt



Square Tarlet Mould, Exopan
方形馅饼模

CODE	SIZE (l x w x h cm)	Packing
6121002	5.7 x 5.7 x 1.0	25 pcs / pkt
6121001	6.8 x 6.8 x 1.2	25 pcs / pkt

Exopan Non-Stick Mould



Round Fluted Tarlet
菊花圆馅饼模

CODE	SIZE (Ø x l cm)	Packaging
6121101	6 x 1.0	25 pcs / pkt
6121103	7 x 1.0	25 pcs / pkt
6121105	8 x 1.2	25 pcs / pkt
6121107	9 x 1.5	12 pcs / pkt
6121108	10 x 1.8	12 pcs / pkt
6121109	11 x 2.0	12 pcs / pkt



Round Plain Tarlet
圆馅饼模

CODE	SIZE (Ø x h cm)	Packaging
6121201	4.5 x 0.9	25 pcs / pkt
6121202	5.0 x 0.9	25 pcs / pkt
6121204	6.0 x 1.0	25 pcs / pkt
6121206	7.0 x 1.0	25 pcs / pkt
6121208	8.0 x 1.2	25 pcs / pkt
6121210	9.0 x 1.3	12 pcs / pkt
6121211	10.0 x 1.5	12 pcs / pkt



Deep Round Plain Tarlet
深圆馅饼模

CODE	SIZE (Ø x h cm)	Packaging
6121301	4.5 x 1.2	25 pcs / pkt
6121302	5.0 x 1.2	25 pcs / pkt
6121304	6.0 x 1.5	25 pcs / pkt
6121306	7.0 x 1.7	25 pcs / pkt
6121308	8.0 x 2.0	25 pcs / pkt



Flan
蛋塔模

CODE	SIZE (Ø x h cm)	Packaging
6121401	6.0 x 1.7	25 pcs / pkt
6121403	7.0 x 1.7	25 pcs / pkt
6121405	8.0 x 1.8	12 pcs / pkt
6121407	9.0 x 1.9	12 pcs / pkt
6121419	10.0 x 2.1	12 pcs / pkt



Genois
菊花蛋糕模

CODE	SIZE (Ø x h cm)	Packaging
6121501	8.5 x 1.6	12 pcs / pkt
6121502	9.5 x 1.7	12 pcs / pkt
6121503	10.5 x 1.8	12 pcs / pkt



Dariole Baba Mould
圆形模

CODE	SIZE (Ø x h cm)	Packaging
6121601	4.5 x 4.5	6 pcs / pkt
6121602	5.0 x 5.0	6 pcs / pkt
6121603	5.5 x 5.5	6 pcs / pkt
6121604	6.0 x 6.0	6 pcs / pkt
6121606	7.0 x 7.0	6 pcs / pkt



Fluted Boat
菊花船形模

CODE	SIZE (l x h cm)	Packaging
6121701	8.5 x 1.0	25 pcs / pkt
6121702	10.0 x 1.1	12 pcs / pkt
6121703	11.0 x 1.2	12 pcs / pkt



Plain Boat
船形模

CODE	SIZE (l x h cm)	Packaging
6121801	8 x 0.9	12 pcs / pkt
6121802	9 x 1.2	12 pcs / pkt
6121803	10 x 1.2	12 pcs / pkt
6121804	11 x 1.2	12 pcs / pkt

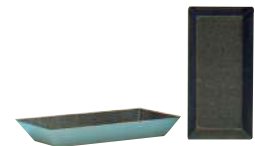

Friand
长方形模

CODE	SIZE (l x w x h cm)	Packaging
6121901	8.6 x 4.3 x 1.2	25 pcs / pkt
6121903	9.8 x 5.2 x 1.4	25 pcs / pkt



Brioche
菊花模

CODE	SIZE (Ø x h cm)	Packing
6122001	6 x 1.5	25 pcs / pkt
6122003	7 x 2.8	25 pcs / pkt
6122005	8 x 3.2	12 pcs / pkt
6122006	9 x 3.6	6 pcs / pkt



Small Waves Brioche
小菊花模

CODE	SIZE (Ø x h cm)	Packaging
6122102	6 x 2.0	25 pcs / pkt
6122104	7 x 2.4	25 pcs / pkt
6122106	8 x 3.0	12 pcs / pkt
6122107	9 x 3.2	12 pcs / pkt



Brioche
小菊花模

CODE	SIZE (Ø x h cm)	Packaging
6122901	10 x 4.0	
6122902	12 x 4.5	

Aluminium Mould



Portuguese Tart Mould
合金蛋塔模

CODE	SIZE (td x bd x ht cm)	REMARKS
6163907	7 x 3.9 x 2.3	SN6061



Round Cup Mould
小蛋糕模

CODE	SIZE (td x bd x ht cm)	REMARKS
6164221	4.7 x 3.3 x 2.5	SN6021
6164222	5.3 x 3.8 x 2.8	SN6022
6164223	5.9 x 4.2 x 3.1	SN6023
6164224	6.5 x 4.7 x 3.4	SN6024
6164225	7.1 x 5.2 x 3.7	SN6025
6164226	7.7 x 5.6 x 4.0	SN6026



Half Sphere Mould
浅半圆模

CODE	SIZE (td x bd x ht cm)	REMARKS
6164405	5.1 x 2.5	SN6041
6164406	6.1 x 3.0	SN6042
6164407	7.0 x 3.5	SN6043



Hemisphere Cake Mould
六层半圆模

CODE	SIZE (Ø x h cm)	REMRKS
6164606	6.1 x 3.0	SN6082
6164607	7.0 x 3.5	SN6083



Dariole Cup
小布丁杯

CODE	SIZE (td x bd x ht cm)	REMARKS
6164104	4.5 x 3.3 x 4.5	SN6011
6164105	5.3 x 3.7 x 5.0	SN6012
6164106	6.0 x 4.5 x 5.6	SN6014
6164108	8.0 x 5.7 x 6.5	SN6017



Round Cake / Tart Mould
大圆模

CODE	SIZE (td x bd x ht cm)	REMARKS
6164309	9.5 x 8.0 x 3.5	SN6031
6164310	10.5 x 9.0 x 3.7	SN6033
6164311	11.0 x 9.3 x 3.8	SN6034



Hemisphere Wavy Cake Mould
半圆小花蛋糕模

CODE	SIZE (td x bd x ht cm)	REMARKS
6164506	6.1 x 3.0	SN6046
6164507	7.0 x 3.5	SN6047



Football Cake Mould
半圆足球模

CODE	SIZE (Ø x h cm)	REMARKS
6164800	Ø 7.0 x 3.5	SN6123



Star Mould
星模

CODE	SIZE (Ø x h cm)	REMARKS
6164900	7.0 x 2.2	SN6102



Peach Cake Mould
桃型模

CODE	SIZE (l x w x h cm)	REMARKS
6165000	8.2 x 7.2 x 3.6	SN6145



Plain Boat Mould
桃型模

CODE	SIZE (l x w x h cm)	REMARKS
6164010	9.0 x 4.0 x 14	SN6151
6164012	11 x 5.5 x 1.3	SN6152



Fluted Boat Mould
船型菊花模

CODE	SIZE (l x w x h cm)	REMARKS
6165110	10 x 4.2 x 1.2	SN6161
6165112	12 x 5.5 x 1.4	SN6162



Brioche Cake Mould
小花蛋糕模

CODE	SIZE (Ø x h cm)	REMARKS
6165200	9.5 x 4	SN6282



Cake Mould
半圆菊花模

CODE	SIZE (Ø x h cm)	REMARKS
6165500	7 x 3.5	SN6238



Cake Mould
小花蛋糕模

CODE	SIZE (td x bd x ht cm)	REMARKS
6165601	6.8 x 4.6 x 3.9	SN6291
6165602	7.3 x 5.0 x 4.2	SN6292
6165603	7.9 x 5.3 x 4.5	SN6293



Fluted Cake Tart Mould
小花蛋糕模

CODE	SIZE (td x bd x ht cm)	REMARKS
6165700	10.5 x 8.1 x 3.1	SN6303



Sponge Cake Mould
海绵盒

CODE	SIZE (l x w x h cm)	REMARKS
6165901	9.6 x 6.6 x 4.0	SN6601
6165902	11 x 8.3 x 4.2	SN6602



Deep Wavy Cap Mould
蛋糕模

CODE	SIZE (td x bd x ht cm)	REMARKS
6166101	7.3 x 3.9	SN6221



Deep Fluted Cake Mould
蛋糕模

CODE	SIZE (l x w x h cm)	REMARKS
6166001	7.0 x 4.1	SN6251

Flexipan® The Original Flexible Mould

has developed a combination of glass fabric and foodgrade silicones: the Flexipan®.



This flexible mould, which was a real revolution for Food professionals, was quickly copied by the silicone injection technics but Flexipan® remains unique with its hither to unequalled quality. Flexipan® can be easily recognized by his knitted fabric structure, especially on the reverse side of the mould. Thanks to its unique combination, Flexipan® is not only a solid and longlasting material, but it also offers exceptional non-stick properties.

Flexipan® has a much longer life than any traditional non-stick coating. Depending on the product, it can be used 2000 to 3000 times before the first signs of sticking appear. Flexipan® can be used to bake or freeze most sweet and savoury products normally metallic moulds. Flexipan® can be used at temperatures varying from - 40°C to + 280°C.

Flexipan® conforms to French, European and US regulations on silicone products in contact with food. Flexipan® has also obtained the N.S.F® certification (National Sainitation Foundation) in February 1997 which guarantees it conforms to construction and performance standards amongst the most demanding in the world. It guarantees to the user of the products complete security as far as hygiene and non toxicity are concerned. Moreover, Demarle can claim to conform to the FDA (food and Drug Administration - USA) Norm. All the products have been approved by the National Test Laboratory (L.N.E).

Uses and recommendations.

Filling

Place your Flexipan® on the perforated baking sheet or grid before filling it to facilitate transport to the oven or the freezer. If some of the indents in the tray are empty, you are advised to fill them with a piece of dough or with water. If not, the indents could lose their non-stick properties.

Baking

The Flexipan® can be used in any oven, ventilated or deck oven. Temperatures and baking times need to be adjusted depending on the oven used. We recommend to reduce the temperature by 10oC and bake a bit longer than in metallic moulds. Flexipan® should be used on a perforated aluminium sheet or grid to maximise the circulation of air. Generally speaking, small pieces should be unmoulded once out of the oven. For fragile product such as sponge cakes and dacquoise sponge, you are advised to let the product cool before unmoulding.

Unmoulding

Depending on the products, unmoulding is easily made either by bending the mould around the frozen products (mousses or crème brulee) or the gelified products or by turning the mould upside down for baked products. In the case of small products, one can even remove them at once just by lifting an edge of the Flexipan® tray.

Cleaning

To clean, simply soak the mould in hot soapy water using a non abrasive sponge and a non aggressive detergent(neutral Ph = 7). Caution: a very aggressive detergent (too acid or too basic) will damage the mould very quickly. You are advised to wash Flexipan® very regularly since, over time, accumulation of grease is detrimental to the durability of the material. After washing, placing the Flexipan® tray in the oven at 150oC for two minutes, will sterilise it and make it perfectly hygienic.

Storage

Flexipan® trays should preferably be stored upside down in piles of 6 at the most. For a few shapes, very deep and straight (like Heart shapes and Cylinders shapes), we strongly recommend you to stock them by pile of 2 mats. If not, after a few months, the mould can lose its original shape for ever.

Flexipan® Mould

Size: 60 x 40 cm

Champagne Biscuits 硅胶烘烤膜

CODE	MOULD SIZE (l x w x h cm)	CAP (ml)	PORTIONS	REMARKS
6170101	10.9 x 2.4 x 1.0	20	45	FP 1130



Mini Charlottes 硅胶烘烤膜

CODE	MOULD SIZE (Ø x h cm)	CAP (ml)	PORTIONS	REMARKS
6170201	3.5 x 1.5	9	60	FP 1071

Charlottes

6170202	6.2 x 3.5	60	24	FP 1079
---------	-----------	----	----	---------



Mini Financiers 硅胶烘烤膜

CODE	MOULD SIZE (l x w x h cm)	CAP (ml)	PORTIONS	REMARKS
6170301	8.7 x 4.7 x 1.4	10	24	FP 1117

Financiers

6170302	5.6 x 2.6 x 1.1	45	24	FP 1264
---------	-----------------	----	----	---------



Fluted Brioches 硅胶烘烤膜

CODE	MOULD SIZE (Ø x h cm)	CAP (ml)	PORTIONS	REMARKS
6170401	7.8 x 3.0	105	24	FP 10373



Mini Madeleines 硅胶烘烤膜

CODE	MOULD SIZE (l x w x h cm)	CAP (ml)	PORTIONS	REMARKS
6170501	5.2 x 3.3 x 1.5	15	56	FP 1121

Madeleines

6170502	7.8 x 4.5 x 1.7	35	40	FP 1511
---------	-----------------	----	----	---------



Mini Muffins 硅胶烘烤膜

CODE	MOULD SIZE (Ø x h cm)	CAP (ml)	PORTIONS	REMARKS
6170601	5.1 x 2.9	45	40	FP 1031



Cupcake 硅胶烘烤膜

CODE	MOULD SIZE (l x w x h cm)	CAP (ml)	PORTIONS	REMARKS
6170701	7.3 x 4.0	125	24	FP 3051



Tarts Tartin 硅胶烘烤膜

CODE	MOULD SIZE (l x w x h cm)	CAP (ml)	PORTIONS	REMARKS
6170801	8.2 x 3	135	15	FP 1897



Mini Cylinders 硅胶烘烤膜

CODE	MOULD SIZE (Ø x h cm)	CAP (ml)	PORTIONS	REMARKS
6170901	4 x 2	25	48	FP 2266

Cylinders

6170902	6.3 x 2.5	65	24	FP 2269
---------	-----------	----	----	---------



Mini Florentiners 硅胶烘烤膜

CODE	MOULD SIZE (Ø x h cm)	CAP (ml)	PORTIONS	REMARKS
6171001	5.9 x 1.3	30	40	FP 115

Florentiners

6171002	7.8 x 1.0	50	24	FP 1441
---------	-----------	----	----	---------



Medaillons 硅胶烘烤膜

CODE	MOULD SIZE (Ø x h cm)	CAP (ml)	PORTIONS	REMARKS
6171101	2.8 x 0.8	5	96	FP 1097



Quiches 硅胶烘烤膜

CODE	MOULD SIZE (Ø x h cm)	CAP (ml)	PORTIONS	REMARKS
6171201	10.2 x 2.0	140	15	FP 112



Mini-Savarins 硅胶烘烤膜

CODE	MOULD SIZE (Ø x h cm)	CAP (ml)	PORTIONS	REMARKS
6171301	4.1 x 1.2	10	60	FP 1586

Savarins

6171302	6.6 x 2.0	50	35	FP 1339
6171303	7.0 x 2.3	65	24	FP 1476



Mini Half Spheres 硅胶烘烤膜

CODE	MOULD SIZE (Ø x h cm)	CAP (ml)	PORTIONS	REMARKS
6171401	2.3 x 1.1	5	63	FP 1242
6171402	2.6 x 1.6	6	96	FP 1977
6171403	2.6 x 1.6	6	45	FP 21977
6171404	2.9 x 1.8	10	70	FP 2265

Half Spheres

6171405	4.2 x 2.1	20	48	FP 1489
6171406	7.0 x 4.0	105	24	FP 1268



Mini-Tartlets 硅胶烘烤膜

CODE	MOULD SIZE (Ø x h cm)	CAP (ml)	PORTIONS	REMARKS
6171501	4.2 x 1.0	13	60	FP 1413

Tartlets

6171502	7.7 x 2.0	65	24	FP 1675
---------	-----------	----	----	---------



Mini Square Savarins 硅胶烘烤膜

CODE	MOULD SIZE (l x w x h cm)	CAP (ml)	PORTIONS	REMARKS
6171601	3.7 x 3.7 x 1.7	15	60	FP 1113

Square Savarins

6171602	5.6 x 5.6 x 2.4	45	35	FP 1105
---------	-----------------	----	----	---------



Square Tartlets 硅胶烘烤膜

CODE	MOULD SIZE (l x w x h cm)	CAP (ml)	PORTIONS	REMARKS
6171701	6.0 x 6.0 x 1.5	40	40	FP 1119



Mini Low Square 硅胶烘烤膜

CODE	MOULD SIZE (l x w x h cm)	CAP (ml)	PORTIONS	REMARKS
6171603	4.5 x 4.5 x 1.2	20	60	FP 1106



Mini Squares 硅胶烘烤膜

CODE	MOULD SIZE (l x w x h cm)	CAP (ml)	PORTIONS	REMARKS
6171801	3.7 x 3.7 x 1.7	18	60	FP 1128

Squares

6171802	5.6 x 5.6 x 2.4	60	35	FP 1133
---------	-----------------	----	----	---------



Mini Brioches 硅胶烘烤膜

CODE	MOULD SIZE (l x w x h cm)	CAP (ml)	PORTIONS	REMARKS
6171901	7.0 x 3.0 x 1.0	15	48	FP 1070



Rectangular Cakes 硅胶烘烤膜

CODE	MOULD SIZE (l x w x h cm)	CAP (ml)	PORTIONS	REMARKS
6172001	8.0 x 3.0 x 3.0	55	24	FP 1532



Cakes Ingots with Cavity 硅胶烘烤膜

CODE	MOULD SIZE (l x w x h cm)	CAP (ml)	PORTIONS	REMARKS
6172101	10 x 4.0 x 2.5	70	24	FP 1158
6172102	12 x 4.0 x 2.5	90	24	FP 1148



Half Cylinders 硅胶烘烤膜

CODE	MOULD SIZE (l x w x h cm)	CAP (ml)	PORTIONS	REMARKS
6172201	8.5 x 1.7 x 1.5	20	48	FP 1146



Ovals 硅胶烘烤膜

CODE	MOULD SIZE (l x w x h cm)	CAP (ml)	PORTIONS	REMARKS
6172301	5.7 x 3.5 x 1.2	18	64	FP 1077



Mini Ovals 硅胶烘烤膜

CODE	MOULD SIZE (l x w x h cm)	CAP (ml)	PORTIONS	REMARKS
6172401	5.1 x 3.1 x 2.0	20	50	FP 2267



Mini Quenelles 硅胶烘烤膜

CODE	MOULD SIZE (l x w x h cm)	CAP (ml)	PORTIONS	REMARKS
6172501	4.2 x 2.6 x 2.0	5.6	72	FP 1072

Quenelles

6172502	6.0 x 4.0 x 2.5	30	42	FP 1052
---------	-----------------	----	----	---------



Mini Oval Tartlet 硅胶烘烤膜

CODE	MOULD SIZE (l x w x h cm)	CAP (ml)	PORTIONS	REMARKS
6172601	6.6 x 2.7 x 1.1	10	48	FP 1982



Mini Pyramids 硅胶烘烤膜

CODE	MOULD SIZE (l x w x h cm)	CAP (ml)	PORTIONS	REMARKS
6172701	3.5 x 3.5 x 2.3	15	54	FP 1562

Pyramids

6172702	5.0 x 5.0 x 3.5	50	35	FP 1882
6172703	7.1 x 7.1 x 4.1	90	24	FP 1585



Mini Savarin Saphirs 硅胶烘烤膜

CODE	MOULD SIZE (l x w x h cm)	CAP (ml)	PORTIONS	REMARKS
6172801	4.0 x 4.0 x 2.4	17	54	FP 1126

Savarin Saphirs

6172802	7.0 x 7.0 x 3.2	80	24	FP 1160
---------	-----------------	----	----	---------



Triangles 硅胶烘烤膜

CODE	MOULD SIZE (l x w x h cm)	CAP (ml)	PORTIONS	REMARKS
6172901	4.8 x 4.1 x 1.0	7	80	FP 1985



Mini Cones 硅胶烘烤膜

CODE	MOULD SIZE (Ø x h cm)	CAP (ml)	PORTIONS	REMARKS
6173001	3.0 x 2.0	6	96	FP 1083



Daisy 硅胶烘烤膜

CODE	MOULD SIZE (Ø x h cm)	CAP (ml)	PORTIONS	REMARKS
6173101	7.0 x 2.8	70	24	FP 1996



Mini Drops 硅胶烘烤膜

CODE	MOULD SIZE (l x w x h cm)	CAP (ml)	PORTIONS	REMARKS
6173201	5.2 x 3.1 x 2.0	18	56	FP 1144



Octagons 硅胶烘烤膜

CODE	MOULD SIZE (l x w x h cm)	CAP (ml)	PORTIONS	REMARKS
6173301	4.3 x 4.0 x 2.6	28	40	FP 1560



Mini Hearts 硅胶烘烤膜

CODE	MOULD SIZE (l x w x h cm)	CAP (ml)	PORTIONS	REMARKS
6173401	4.1 x 3.8 x 1.6	15	70	FP 1136



Stars 硅胶烘烤膜

CODE	MOULD SIZE (l x w x h cm)	CAP (ml)	PORTIONS	REMARKS
6173501	8.0 x 6.5 x 1.5	35	24	FP 1061



Teddy Bear 硅胶烘烤膜

CODE	MOULD SIZE (l x w x h cm)	CAP (ml)	PORTIONS	REMARKS
6173601	9.0 x 5.5 x 2.0	80	18	FP 1056



Mini Logs 硅胶烘烤膜

CODE	MOULD SIZE (l x w x h cm)	CAP (ml)	PORTIONS	REMARKS
6173701	9.5 x 4.0 x 3.0	80	24	FP 1039



Christmas Logs 硅胶烘烤膜

CODE	MOULD SIZE (l x w x h cm)	CAP (ml)	PORTIONS	REMARKS
6173801	33.9 x 4.0 x 3.9	450	8	FP 1454



Christmas Logs XXL 硅胶烘烤膜

CODE	MOULD SIZE (l x w x h cm)	CAP (ml)	PORTIONS	REMARKS
6173901	49.5 x 4.0 x 3.9	700	5	FP 1464



Round Inserts 硅胶烘烤膜

CODE	MOULD SIZE (Ø x h cm)	CAP (ml)	PORTIONS	REMARKS
6174001	14.7 x 1.2	200	6	FP 122
6174002	18.6 x 1.2	300	6	FP 123



Flexipan® Mats For Dessert

Mat 硅胶烘焙垫

CODE	MOULD SIZE (l x w x h cm)	REMARKS
6174101	55.5 x 36.0 x 1.0	FT 1010

Mat

6174102	34.8 x 24.8 x 2.0	FT 2020
---------	-------------------	---------



Relief Pastry Mats 硅烘焙垫



Christmas Log

CODE	SIZE (l cm)
6174201	48 x 17
TF 0130	

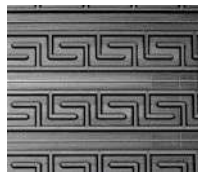

Large Greek

CODE	SIZE (l x w cm)
6174202	57.5 x 37.5
TF 0140	

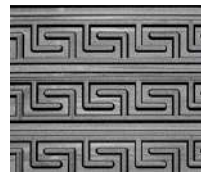

Small Greek

CODE	SIZE (l x w cm)
6174203	57.5 x 37.5
TF 0150	

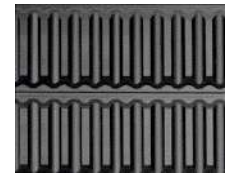

Straight Flute

CODE	SIZE (l x w cm)
6174204	57.5 x 37.5
TF 0160	

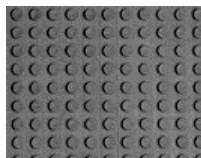

Bubbles

CODE	SIZE (l x w cm)
6174205	57.5 x 37.5
TF 0170	



Dome

CODE	SIZE (l x w cm)
6174206	57.5 x 37.5
TF 0180	



Venetian Cave

CODE	SIZE (l x w cm)
6174207	57.5 x 37.5
TF 0190	



Variation

CODE	SIZE (l x w cm)
6174208	57.5 x 37.5
TF 0200	



Rising Sun

CODE	SIZE (l x w cm)
6174209	57.5 x 37.5
TF 1010	



Labyrinth

CODE	SIZE (l x w cm)
6174210	49.6 x 29.3
TF 7000	



Yin & Yang

CODE	SIZE (l x w cm)
6174211	24
TF 0010	



Snowflake

CODE	SIZE (l cm)
6174212	24
TF 0020	



Rosette

CODE	SIZE (l cm)
6174213	24
TF 0100	



Spiral

CODE	SIZE (l cm)
6174214	24

The Dough Lining Device

CODE	MOULD SIZE (l cm)	SPEC fit for
6174301		FP 1413, FP 1600, FP 1066, FP 1982



Special Cutter Stainless Steel

Mini Heart

CODE	MOULD SIZE (l x w cm)	USE FOR	REMARKS
6174401	3.8 x 3.5	FP 1136 Flexipan	DEC 1136



Mini Drop

CODE	MOULD SIZE (l x w cm)	USE FOR	REMARKS
6174402	4.5 x 2.5	FP 1144 Flexipan	DEC 1144



Charlotte

CODE	MOULD SIZE (Ø cm)	USE FOR	REMARKS
6174403	5.8	FP 1059 Flexipan	DEC 1059



Hexagon

CODE	MOULD SIZE (l x w cm)	USE FOR	REMARKS
6174405	7.2 x 7.2	FP 1180 Flexipan	DEC 1180



Medium Charlotte

6174404	8.0	FP 1079 Flexipan	DEC 1079
---------	-----	------------------	----------

Mini Sapphires

CODE	MOULD SIZE (l x w cm)	USE FOR	REMARKS
6174406	3.7 x 3.7	FP 1126 Flexipan	DEC 1126

Square

CODE	MOULD SIZE (l x w cm)	USE FOR	REMARKS
6174408	5.6 x 5.6	FP 1105 Flexipan	DEC 1105
6174409	7.0 x 7.0	FP 1102 Flexipan	DEC 1102

Sapphires

6174407	6.7 x 6.7	FP 1124 Flexipan	DEC 1124
---------	-----------	------------------	----------



Special Cutter Exoglass

Round

CODE	MOULD SIZE (Ø cm)	USE FOR	REMARKS
6174501	5.0	FP 1413 Flexipan	MA 152115
6174502	7.5	FP 1066 Flexipan	MA 152120



Spoon

CODE	MOULD SIZE (Ø cm)	USE FOR	REMARKS
6174503	5.0	FP 1413 Flexipan	MA 150214

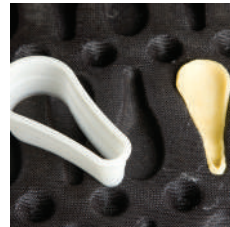

Silform® for Choux Pastry 60 x 40 cm

Several Silform® shapes have been specially developed for choux pastry. Thanks to the round or elongated shapes, piping choux pastry is easy and products are evenly calibrated. The choux pastry which has a naturally supple texture* glides and fits perfectly the silform® shape. The choux pastry does not need to be glazed or scratched. It is preferable to bake the choux pastry in a deck oven. When removed from the oven, the finished product will be perfectly even and smooth on top. Thanks to the non-stick texture of Silform®, tipping out is faultless. The bottom is light and clean which means that the choux is stable and ready to decorate.

Chouquettes 硅胶烘烤膜

CODE	MOULD SIZE (Ø x h cm)	CAP (ml)	PORTIONS	REMARKS
6175101	3.8 x 1.0	14	54	SF 2435



Big Choux 硅胶烘烤膜

CODE	MOULD SIZE (Ø x h cm)	CAP (ml)	PORTIONS	REMARKS
6175001	6.7 x 1.5	48	28	SF 0002



Eclairs For Right Handed 硅胶烘烤膜

CODE	MOULD SIZE (l x w x h cm)	CAP (ml)	PORTIONS	REMARKS
6175201	12.5 x 2.5 x 5.0	15	18	SF 1090



Silform® for Tartlets 60 x 40 cm

Producing tartlet bases (part or fully baked) has become much easier with the new range of Silform® Tartlets. No need to prick or to line the dough, or even to garnish with dry beans anymore. You can even use the mat on the reverse side!

Due to its silicone components, this mould is non-stick and therefore doesn't need greasing. Moreover, the perforated texture of the Silform® allows a perfect and uniform, heat diffusion for an optimum quality of baking and a perfectly crusty pastry.

Spoons 硅胶烘烤膜

CODE	MOULD SIZE (l x w x h cm)	CAP (ml)	PORTIONS	REMARKS
6175301	9.0 x 2.8 x 1.2	15	36	SF 1127



Mini Squares 硅胶烘烤膜

CODE	MOULD SIZE (l x w x h cm)	CAP (ml)	PORTIONS	REMARKS
6175401	4.5 x 4.5 x 1.2	20	60	SF 1106



Squares

6175402	6.0 x 6.0 x 1.5	40	40	SF 1119
---------	-----------------	----	----	---------

Mini Tartlets 硅胶烘烤膜

CODE	MOULD SIZE (Ø x h cm)	CAP (ml)	PORTIONS	REMARKS
6175501	4.2 x 1.0	13	60	SF 1413



Mini Fluted Tartlets 硅胶烘烤膜

CODE	MOULD SIZE (Ø x h cm)	CAP (ml)	PORTIONS	REMARKS
6175601	4.6 x 1.5	11	40	SF 1082



Tartlets

6175502	7.7 x 2.0	65	24	SF 1675
---------	-----------	----	----	---------



silikomart[®] professional

The moulds made of 100% silicone suitable for alimentary use from Silikomart Professional, are ideal for the preparation of sweet and salty recipes. Light, resistant and practical are the best alternative to all baking trays and moulds made of other materials.

They can be used while cooking in the gas or electric oven, in the grill; on the wire rack shelf, in the microwave and to consolidate in the freezer or in the blast chiller: it resists temperatures from - 60°C to + 230°C, can be transferred directly from the

freezer to the oven without any variation in material characteristics.

The thermal conductivity of the silicone guarantees excellent results when baking, while the natural non-stick ability and flexibility, allows quick, easy and perfect turning out, reducing loss of time and of ingredients

They can easily be washed under hot running water, with a sponge, or in the dishwasher. They can be stored using minimal space; folded or rolled, as they always return to their original shape. The correct use guarantees a superior duration to other traditional products.

MODULARI / MODULAR

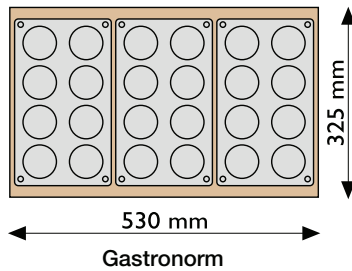

MODULARI / MODULAR

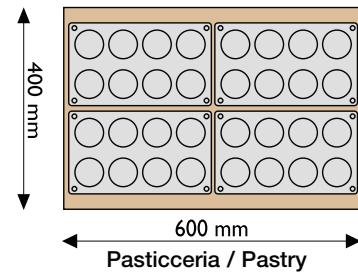

ROUND



Code: **6180101**

SF001 Half-Sphere

Ø 80 h 40 mm
Ø 3,15 h 1,57 inches
Vol. 5x120 ml Tot. 600 ml

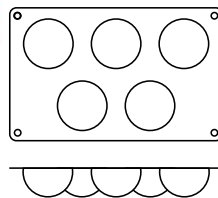

Code: **6180102**

SF002 Half-Sphere

Ø 70 h 35 mm
Ø 2,76 h 1,38 inches
Vol. 6x80 ml Tot. 480 ml

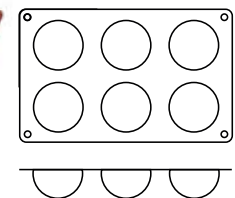

Code: **6180103**

SF003 Half-Sphere

Ø 60 h 30 mm
Ø 2,36 h 1,18 inches
Vol. 6x60 ml Tot. 360 ml

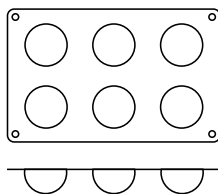

Code: **6180105**

SF005 Half-Sphere

Ø 40 h 20 mm
Ø 1,57 h 0,79 inches
Vol. 15x20 ml Tot. 300 ml

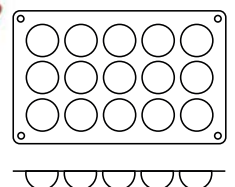

Code: 6180106

SF006 Half-Sphere

Ø 30 h 15 mm
Ø 1,18 h 0,59 inches
Vol. 24x10 ml Tot. 240 ml

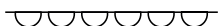
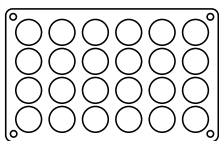

Code: 6180201

SF010 Small Savarin

Ø 41 h 12 mm
Ø 1,61 h 0,47 inches
Vol. 18x18 ml Tot. 324 ml

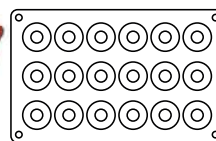

Code: 6180202

SF011 Medium Savarin

Ø 65 h 21 mm
Ø 2,56 h 0,83 inches
Vol. 8x50 ml Tot. 400 ml

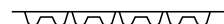
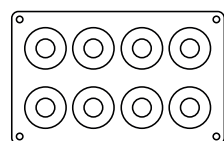

Code: 6180203

SF012 Big Savarin

Ø 72 h 23 mm
Ø 2,83 h 0,91 inches
Vol. 6x62 ml Tot. 372 ml

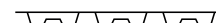
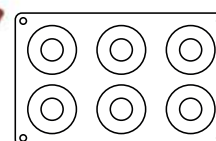

Code: 6180303

SF015 Tartelette

Ø 60 h 17 mm
Ø 2,36 h 0,67 inches
Vol. 8x40 ml Tot. 320 ml

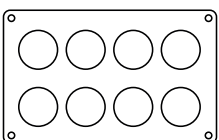

Code: 6180302

SF014 Tartelette

Ø 50 h 15 mm
Ø 1,97 h 0,59 inches
Vol. 15x25 ml Tot. 375 ml

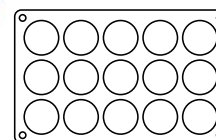

Code: 6180403

SF021 Big Baba

Ø 55 h 60 mm
Ø 2,17 h 2,36 inches
Vol. 8x92 ml Tot. 736 ml

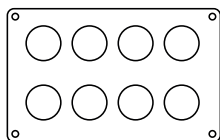

Code: 6180401

SF019 Small Baba

Ø 35 h 38 mm
Ø 1,38 h 1,50 inches
Vol. 15x30 ml Tot. 450 ml

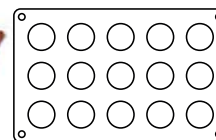
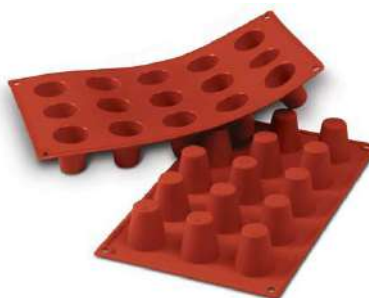

Code: 6180402

SF020 Medium Baba

Ø 45 h 48 mm
Ø 1,77 h 1,89 inches
Vol. 11x50 ml Tot. 550 ml

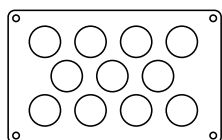

Code: 6180501

SF027 Petits-Fours

Ø 40 h 20 mm
Ø 1,57 h 0,79 inches
Vol. 15x30 ml Tot. 450 ml

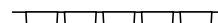
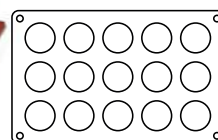

Code: **6180502**



SF028 Cylinders

Ø 60 h 35 mm
Ø 2,36 h 1,38 inches
Vol. 8x90 ml Tot. 720 ml

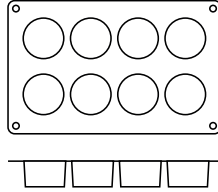

Code: **6180601**



SF030 Mini Florentins

Ø 35 h 5 mm
Ø 1,38 h 0,20 inches
Vol. 24x5 ml Tot. 120 ml

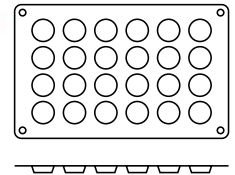

Code: **6181601**



SF042 Sponge Base

Ø 103 h 20 mm
Ø 4,05 h 0,79 inches
Vol. 3x140 ml Tot. 420 ml

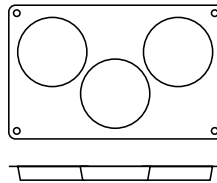

Code: **6181701**



SF043 Flan Mould

Ø 40 h 13 mm
Ø 1,57 h 0,51 inches
Vol. 15x20 ml Tot. 300 ml

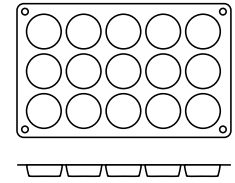

Code: **6181702**



SF044 Flan Mould

Ø 50 h 14 mm
Ø 1,97 h 0,55 inches
Vol. 15x30 ml Tot. 450 ml

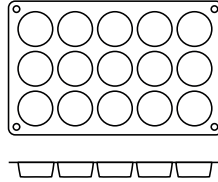

Code: **6181703**



SF045 Flan Mould

Ø 60 h 17 mm
Ø 2,36 h 0,67 inches
Vol. 8x42 ml Tot. 336 ml

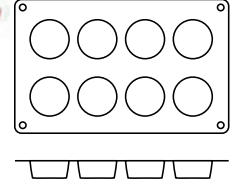

Code: **6181704**



SF047 Flan Mould

Ø 80 h 18 mm
Ø 3,15 h 0,70 inches
Vol. 6x72 ml Tot. 432 ml

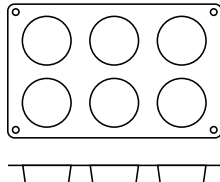

Code: **6181801**



SF048 Small Diamond

Ø 35 h 23 mm
Ø 1,38 h 0,91 inches
Vol. 18x20 ml Tot. 360 ml

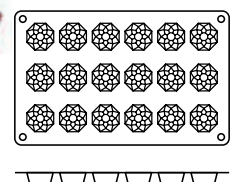

Code: **6180701**



SF086 Magic Dome

Ø 75 h 40 mm
Ø 2,95 h 1,57 inches
Vol. 6x115 ml Tot. 690 ml

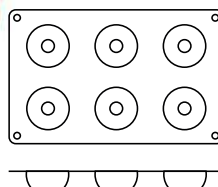

Code: **6180801**



SF095 Small Vulcano

Ø 36 h 31 mm
Ø 1,41 h 1,22 inches
Vol. 24x16 ml Tot. 384 ml

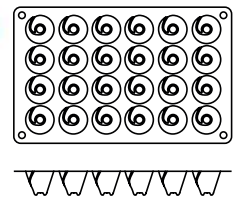



ELLIPSE



Code: **6180901**

SF018 Medium Ovals

70 x 50 h 20 mm
2,76 x 1,97 h 0,79 inches
Vol. 9x50 ml Tot. 450 ml

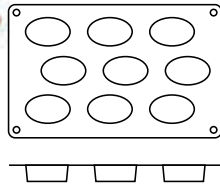

Code: **6181001**

SF055 Big Ovals

75 x 55 h 35 mm
2,95 x 2,16 h 1,38 inches
Vol. 8x110 ml Tot. 880 ml

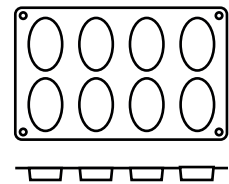

Code: **6181901**

SF038 Medium Boat

72 x 30 h 15 mm
2,83 x 1,18 h 0,59 inches
Vol. 12x20 ml Tot. 240 ml

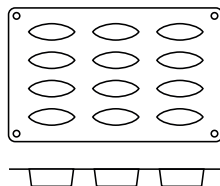

Code: **6181902**

SF039 Big Boat

100 x 44 h 15 mm
3,94 x 1,73 h 0,59 inches
Vol. 9x40 ml Tot. 360 ml

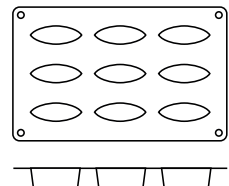

Code: **6181101**

SF084 Medium Oval Savarin

67 x 49 h 23 mm
2,63 x 1,92 h 0,90 inches
Vol. 10x48 ml Tot. 480 ml

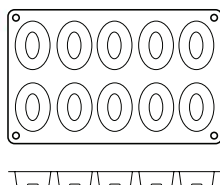

Code: **6181102**

SF085 Big Oval Savarin

74 x 57 h 27 mm
2,91 x 2,24 h 1,06 inches
Vol. 8x72 ml Tot. 576 ml

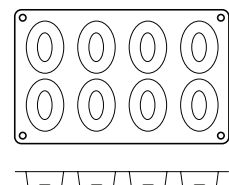



RECTANGLE



Code: **6181201**



SF025 Financiers

49 x 26 h 11 mm
1,93 x 1,02 h 0,43 inches
Vol. 20x20 ml Tot. 400 ml

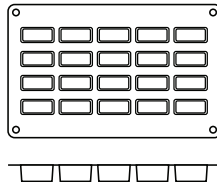

Code: **6181401**



SF054 Big Financiers

95 x 45 h 12 mm
3,74 x 1,77 h 0,47 inches
Vol. 7x50 ml Tot. 350 ml

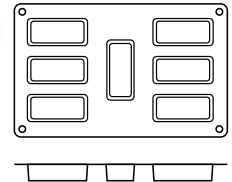

Code: **6181301**



SF026 Cakes

79 x 29 h 30 mm
3,11 x 1,14 h 1,18 inches
Vol. 12x70 ml Tot. 840 ml

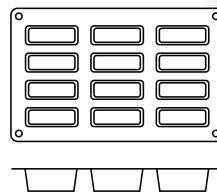

Code: **6181501**



SF092 Small Lingotto

41 x 23 h 21 mm
1,61 x 0,91 h 0,82 inches
Vol. 25x16 ml Tot. 400 ml

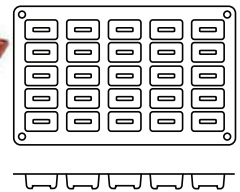

Code: **6181502**



SF090 Big Lingotto

72 x 45 h 26 mm
2,84 x 1,77 h 1,02 inches
Vol. 8x72 ml Tot. 576 ml

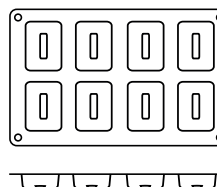



SQUARE



Code: **6182002**

SF081 Medium Square Savarin

45,5 x 45,5 h 28 mm
1,79 x 1,79 h 1,10 inches
Vol. 15x45 ml Tot. 675 ml

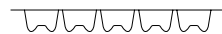
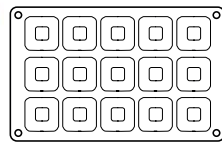

Code: **6182003**

SF082 Big Square Savarin

62,5 x 62,5 h 25 mm
2,46 x 2,46 h 0,98 inches
Vol. 8x73 ml Tot. 584 ml

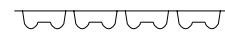
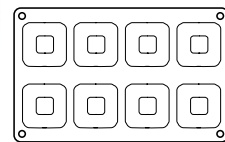

Code: **6182101**

SF105 Cube

35 x 35 h 35 mm
1,38 x 1,38 x 1,38 inches
Vol. 15x42 ml Tot. 630 ml

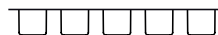
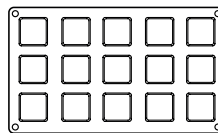



CLASSIC



Code: **6183102**



SF007 Pyramids

71 x 71 h 40 mm
2,80 x 2,80 h 1,57 inches
Vol. 6x90 ml Tot. 540 ml

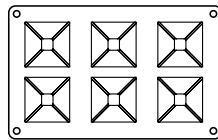

Code: **6183101**



SF008 Pyramids

36 x 36 h 22 mm
1,42 x 1,42 h 0,87 inches
Vol. 15x20 ml Tot. 300 ml

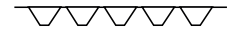
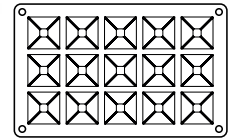

Code: **6184701**



SF009 Pomponnetes

Ø 34 h 16 mm
Ø 1,34 h 0,63 inches
Vol. 24x18 ml Tot. 432 ml

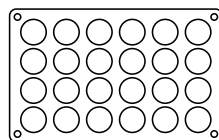

Code: **6182201**



SF022 Small Muffin

Ø 51 h 28 mm
Ø 2,01 h 1,10 inches
Vol. 11x50 ml Tot. 550 ml

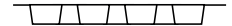
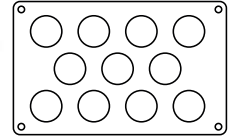

Code: **6182202**



SF023 Medium Muffin

Ø 69 h 35 mm
Ø 2,72 h 1,38 inches
Vol. 6x100 ml Tot. 600 ml

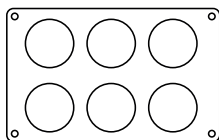

Code: **6182203**



SF024 Big Muffin

Ø 81 h 32 mm
Ø 3,19 h 1,26 inches
Vol. 5x135 ml Tot. 675 ml

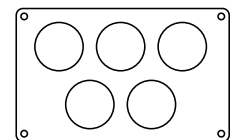

Code: **6182301**



SF052 Big Muffin

Ø 75 h 60 mm
Ø 2,95 h 2,36 inches
Vol. 6x165 ml Tot. 990 ml

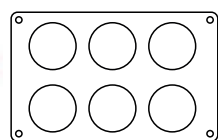

Code: **6182401**



SF031 Mini Madeleine

44 x 34 h 10 mm
1,73 x 1,34 h 0,39 inches
Vol. 15x10 ml Tot. 150 ml

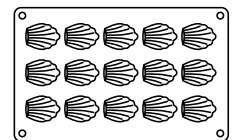

Code: 6182402



SF032 Madeleine

68 x 45 h 17 mm
2,68 x 1,77 h 0,67 inches
Vol. 9x30 ml Tot. 270 ml

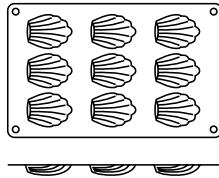

Code: 6182501

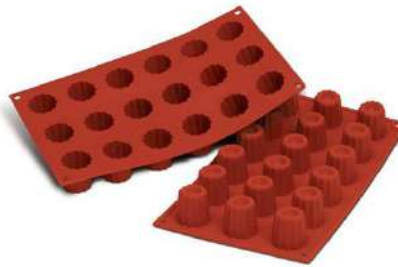

SF033 Small Bordelais

Ø 35 h 35 mm
Ø 1,38 h 1,38 inches
Vol. 18x30 ml Tot. 540 ml

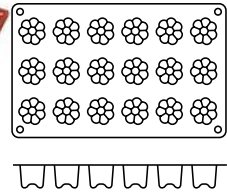

Code: 6182502



SF059 Medium Bordelais

Ø 45 h 45 mm
Ø 1,77 h 1,77 inches
Vol. 15x60 ml Tot. 900 ml

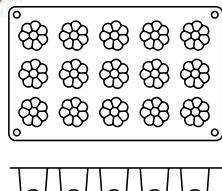

Code: 6182601



SF034 Briochette

Ø 79 h 37 mm
Ø 3,11 h 1,46 inches
Vol. 6x110 ml Tot. 660 ml

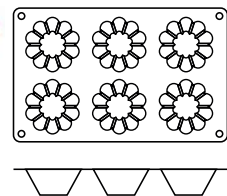

Code: 6182701

SF058 Gugelhupf

Ø 70 h 36 mm
Ø 2,76 h 1,42 inches
Vol. 6x80 ml Tot. 480 ml

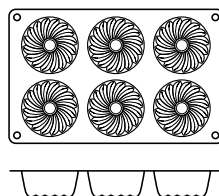



DESIGN



Code: **6182802**

SF077 Rose

Ø 76 h 40 mm
Ø 2,99 h 1,57 inches
Vol. 6x115 ml Tot. 690 ml

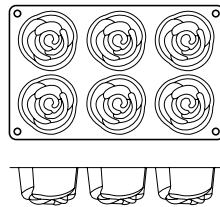

Code: **6183001**

SF063 HERMINE

113 x 71 h 30 mm
4,45 x 2,8 h 1,18 inches
Vol. 6x80 ml Tot. 480 ml

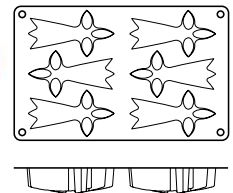

CELEBRATION



Code: **6183201**

SF040 Heart

Ø 60 h 35 mm
Ø 2,36 h 1,38 inches
Vol. 8x90 ml Tot. 720 ml

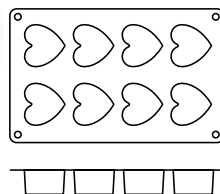

Code: **6182903**

SF087 Big Passion

59 x 62 h 32 mm
2,32 x 2,44 h 1,25 inches
Vol. 8x72 ml Tot. 576 ml

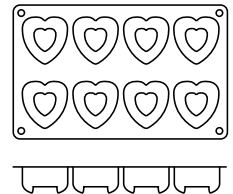

Code: **6182901**

SF089 Small Passion

33 x 35 h 22 mm
1,29 x 1,37 h 0,86 inches
Vol. 24x16 ml Tot. 384 ml

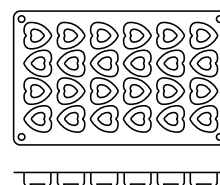

GLOBE 6183301

Size: Ø 45 h 20 mm
Volume: 26 ml



PILLOW 6183302

Size: 82 x 43 h 32 mm
Volume: 81 ml



PARFUM 6183303

Size: Ø 75 h 37,5 mm
Volume: 108 ml



Use:



• Fill the mould with preparation



• Level and put the mould into the shock freezer.



• Unmould



• Garnish with decorations at will

MINI TRUFFLES 6183305

36.172.87.0065

Size: Ø 32 h 28 mm

Volume: 20 ml



AMORINI 6183306

36.186.87.0065

Size: 63x65 h 39 mm

Volume: 96 ml



QUENELLE²⁴ 6183304

Size: 63x29 h 28 mm
Volume: 24 ml



Silikomart Professional presents a new, elegant shape perfect to create 3D sweet or savoury quenelle. This mould is conceived and made with maximum care combining beauty and handiness. The new shape is provided with a special and innovative border in the upper part which gives a particular round shape to the base of pastries. This new technology and the flexibility of the high quality guarantee an easy and perfect unmould in every single detail, ensuring perfect results and total fidelity to the shape. An inevitable tool in every laboratory, **QUENELLE²⁴** therefore it is suitable for semifreddos but also for ice cream and baked creations.

Use:



• Fill the mould



• Cover with sponge base

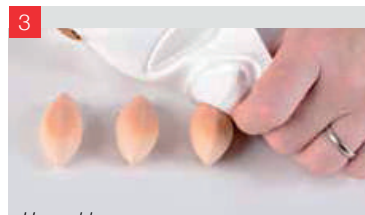

• Unmould

INSERT DECOR ROUND 6183401

for creation from Ø40 up to Ø 260 pitch 20 mm



Designed to make square or circular shaped inserts and decorations to be placed inside or on the surface of ice cream cakes, semifreddos or baked preparations, **INSERT DECOR** is thought to enhance with originality and elegance the creations of professionals. Extremely practical and functional, Insert Decor allows to make decorations of 12 different sizes (6 for each side of the mould), resulting suitable for preparations of the most different sizes.



• Fill the mould with the preparation



• Unmold



• Create the ice cream base for the TOR mould.



• Put the cake-insert in the TOR.



• Cover the insert with the preparation.

ARMONIA 6183402

Size: Ø 180-40 h 50 mm
Volume: 1000 ml



INSERT
DECOR ROUND



6183401



Elegant waves wrap delicate notes of taste. Style and elegance, that's what distinguishes this mould with a unique shape. Created in collaboration with the Team Italia composed by the president Gino Fabbri, the captain Lucca Cantarin, Francesco and Marcello Boccia and the coach Alessandro Dalmaso, ARMONIA is perfect for ice cream but also baked preparations, ensuring flawless results.



Use:



- Fill 1/3 of the Armonia mould with the first preparation



- Put the preparation of the Insert Decor Round mould into the Armonia mould



- Fill up the mould to the top with the second preparation



- Level



- Cover with sponge base



- Unmould

INSERT DECOR SQUARE 6183501

for creation from 40x40 up to 260x260 pitch 20 mm



- Fill the mould with preparation.



- unmold.



- Create the ice cream base in the TOR mould.



- Cover and level it; put the mould with the corresponding tray into the shock freezer.



- Take the cake out of the mould.

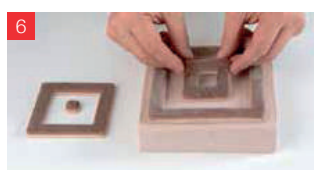

- Put the decoration on the TOR.

ECLIPSE 6183601

Size: Ø 180 h 45 mm
Volume: 1000 ml



Essential, sinuous, with a round shaped surface.

Eclipse differs from all the other baking pan moulds because it is equipped with two silicone parts, one of which (A) extremely flexible, apt to further simplify the phase of unmould and to reduce the time of production during the processing.



Use:



- Fill 1/3 of the part B of the Eclipse mould with the first preparation



- Put the sponge base (SQ012 - Disco)



- Close up the Eclipse mould with the part A



- Fill the Eclipse mould with the second preparation



- Cover with sponge base



- Unmould

JR. PILLOW 6183701

Size: 190x73 h 60 mm
Volume: 60 ml



Use:



• Fill the Jr Pillow



• Put the cake-insert

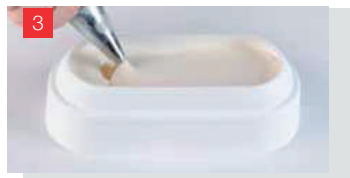

• Fill up the mould to the top with the second preparation



• Cover with sponge base



• Unmould

PARADISE 6183801

Size: Ø 220/70 h 60 mm
Volume: 1500 ml



INSERT DECOR ROUND



6183401



DECOR ROUND!

World champion! Awarded to the World Cup of Ice Cream 2012, PARADISE allows to make in a practical and fast way a cake sectioned into 14 portions. The mould is ideal for ice-cream cakes, semifreddos but also for baked preparations. And for an extra touch of originality, you can match the preparations created with PARADISE with the decorations made with INSERT DECOR ROUND!



• Fill the BUC mould with the preparation



• Cover and level it; put the mould with the corresponding tray into the shock freezer



• Take the cake out of the mould



• Fill the ID01 ROUND with the insert preparation



• Take the cake out of the mould



• Put the decoration on the cake

KIT BÛCHE MATELASSÈ

250 x 80 h 70 mm
Volume 1300 ml
6183903



+

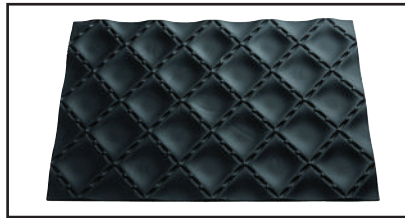

INDIVIDUAL TEXTURE MAT

TEX01 WOOD

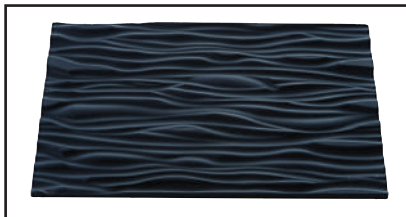

250 x 185 h 6 mm
6184001



TEX02 VIENNA

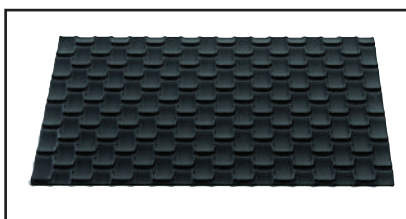

250 x 185 h 6 mm
6184002

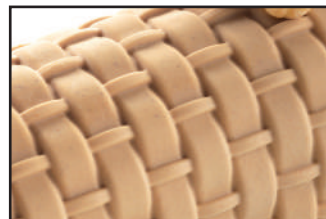

TEX04 POIS

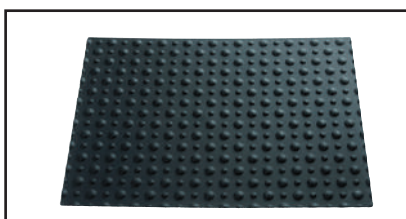

250 x 185 h 6 mm
6184004



Silicon Uniflex Mould



Baby Plum Cake 长方形

CODE	MOULD SIZE (l x w x h cm)	SPEC
6184101	17.1 x 8.3 x 4	300 ml



Heart 心形

CODE	SIZE (l x w x h cm)	SPEC (L)
6184201	22 x 21.8 x 4	1.25



Flan Pan 圆形

CODE	MOULD SIZE (Ø x h cm)	SPEC (L)
6184301	24 x 3	1.25
6184302	26 x 3	1.30



Narcissus 水仙花形

CODE	MOULD SIZE (Ø x h cm)	SPEC (L)
6184401	18 x 7.3	1.3



Daffy Duck 鸭形

CODE	MOULD SIZE (l x w cm)
6184501	27.5 x 33



Tom & Jerry 猫和老鼠形

CODE	MOULD SIZE (l x w cm)
6184502	38.7 x 19



Tom 汤姆猫形

CODE	MOULD SIZE (l x w cm)
6184503	13.8 x 14.5



Bugs Bunny 兔巴哥形

CODE	MOULD SIZE (l x w cm)
6184504	20 x 10.5



Daffy Duck 鸭头形

CODE	MOULD SIZE (l x w cm)
6184505	18 x 16.5



Tweety Bird 小黄鸟形

CODE	MOULD SIZE (l x w cm)
6184506	30.5 x 23.5



Tweety Bird 小黄鸟头形

CODE	MOULD SIZE (l x w cm)
6184507	15.5 x 14



Sylvester 猫头形

CODE	MOULD SIZE (l x w cm)
6184508	16.2 x 14.7



Road Runner 鸡形

CODE	MOULD SIZE (l x w cm)
6184509	16.5 x 15.5



Wile E. Coyote 狐狸头形

CODE	MOULD SIZE (l x w cm)
6184510	16 x 15



CIOCCOLATO CHOCOLATE



Hearts
心形

CODE	MOULD SIZE (l x w x h cm)	SPEC
6184601	3 x 2.2 x 2.5	15 - Moulds x 10 ml



Cubes
方形

CODE	MOULD SIZE (l x w x h cm)	SPEC
6184602	2.6 x 2.6 x 1.8	15 - Moulds x 10 ml



Half Spheres
圆形

CODE	MOULD SIZE (Ø x h cm)	SPEC
6184603	2.8 x 2	15 - Moulds x 10 ml



Round
圆形

CODE	MOULD SIZE (Ø x h cm)	SPEC
6184604	2.8 x 2	15 - Moulds x 10 ml

Plastic Decorating Stencils 塑胶模具



CODE	SPEC	CODE	SPEC
6190101	Heart	6190501	Square
6190201	Rhomb	6190601	Curve Stripe
6190301	Christmas	6190701	Stripe
6190401	Asymmetric	6190801	Square Stripe

Size: 60 x 40 cm



6190101 Heart

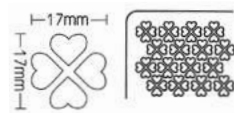

6190501 Square

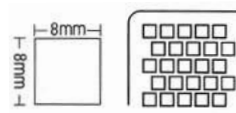

6190201 Rhomb

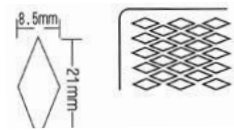

6190601 Curve Stripe

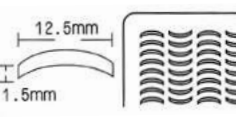

6190301 Christmas

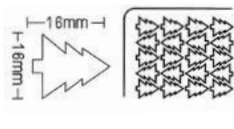

6190701 Stripe

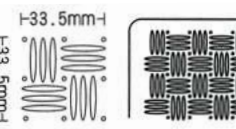

6190401 Asymmetric

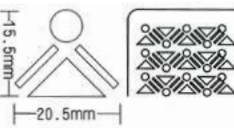

6190801 Square Stripe

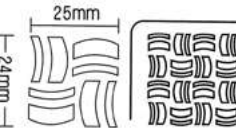

Plastic Cake Stencils 塑胶蛋糕模具

GOURMET
STEEL

CODE	SIZE (l x w x h cm)	REMARKS	CODE	SIZE (l x w x h cm)	REMARKS
6190901	14.8 x 14.8 x 0.2	M1	6190908	14.8 x 14.8 x 0.2	M8
6190902	14.8 x 14.8 x 0.2	M2	6190909	14.8 x 14.8 x 0.2	M9
6190903	14.8 x 14.8 x 0.2	M3	6190910	14.8 x 14.8 x 0.2	M10
6190904	14.8 x 14.8 x 0.2	M4	6190911	14.8 x 14.8 x 0.2	X32
6190905	14.8 x 14.8 x 0.2	M5	6190912	14.8 x 14.8 x 0.2	X34
6190906	14.8 x 14.8 x 0.2	M6	6190913	14.8 x 14.8 x 0.2	A1
6190907	14.8 x 14.8 x 0.2	M7	6190914	14.8 x 14.8 x 0.2	A2



6190901



6190902



6190905

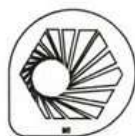

6190906



6190909



6190910



6190913



6190903



6190904

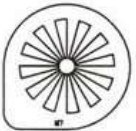

6190907

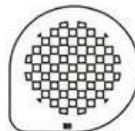

6190908



6190911



6190912



6190914



6192001

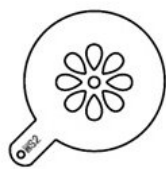

6192002



6192003



6192004



6192005

Plastic Decorating Small Stencil 圆型塑胶模具

CODE	SIZE (Ø cm)	REMARKS
6192001	11	MS1
6192002	11	MS2
6192003	11	MS4
6192004	11	MS9
6192005	11	MS18



6192101



6192102



6192103



6192104

Set of 5-pcs Decorating Stencils 模具 (5件)

CODE	SIZE (l cm)
6192101	17 / 14 / 12 / 9.5 / 7
6192102	17 / 14 / 12 / 9.5 / 7
6192103	17 / 14 / 12 / 9.5 / 7
6192104	17 / 14 / 12 / 9.5 / 7



Stainless Steel Ring



Tart Ring
圆钢蛋糕圈

CODE	SIZE (Ø x h cm)	Packing	CODE	SIZE (Ø x h cm)
6220201	6 x 1.6	10 pcs / pkt	6220211	16 x 1.6
6220203	7 x 1.6	10 pcs / pkt	6220212	18 x 1.6
6220205	8 x 1.6	10 pcs / pkt	6220213	20 x 21
6220207	9 x 1.6	10 pcs / pkt	6220215	24 x 21
6220208	10 x 1.6	10 pcs / pkt	6220217	28 x 21
6220210	14 x 1.6	10 pcs / pkt		

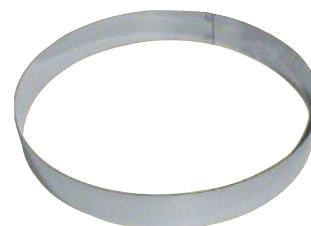

Entremet Ring
圆钢蛋糕圈

CODE	SIZE (Ø x h cm)	CODE	SIZE (Ø x h cm)
6220101	10 x 3.5	6220108	20 x 3.5
6220103	12 x 3.5	6220110	24 x 3.5
6220104	14 x 3.5	6220111	26 x 3.5
6220106	16 x 3.5	6220113	30 x 3.5
6220107	18 x 3.5		

Mousse Ring
圆钢慕斯圈

CODE	SIZE (Ø x h cm)	CODE	SIZE (Ø x h cm)
6220301	10 x 4.5	6220308	20 x 4.5
6220303	12 x 4.5	6220310	24 x 4.5
6220304	14 x 4.5	6220311	26 x 4.5
6220306	16 x 4.5	6220313	30 x 4.5
6220307	18 x 4.5		



Ice Cake Ring
圆钢蛋糕圈

CODE	SIZE (Ø x h cm)	CODE	SIZE (Ø x h cm)
6220401	10 x 6	6220408	20 x 6
6220403	12 x 6	6220410	24 x 6
6220404	14 x 6	6220411	26 x 6
6220406	16 x 6	6220412	30 x 6
6220407	18 x 6		



Oval Entremet Ring
椭圆形钢圈

CODE	SIZE (l x w x h cm)
6220602	21 x 14 x 3.5
6220603	23 x 14 x 3.5
6220604	25 x 14 x 3.5
6220606	29 x 14 x 3.5



Oval Mousse Ring
椭圆形钢慕斯圈

CODE	SIZE (l x w x h cm)
6220702	21 x 14 x 4.5
6220703	23 x 16 x 4.5
6220704	25 x 18 x 4.5
6220706	29 x 23 x 4.5



Hexagon Entremet Ring
六角形钢蛋糕圈

CODE	SIZE (Ø x h cm)	CODE	SIZE (Ø x h cm)
6220802	16 x 3.5	6220806	24 x 3.5
6220803	18 x 3.5	6220807	26 x 3.5
6220804	20 x 3.5	6220808	28 x 3.5

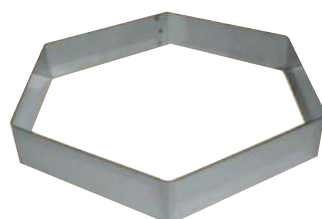

Square Entremet Ring
四方钢蛋糕圈

CODE	SIZE (l x w x h cm)	CODE	SIZE (l x w x h cm)
6221803	16 x 16 x 3.5	6221807	24 x 24 x 3.5
6221804	18 x 18 x 3.5	6221808	26 x 26 x 3.5
6221805	20 x 20 x 3.5	6221810	30 x 30 x 3.5

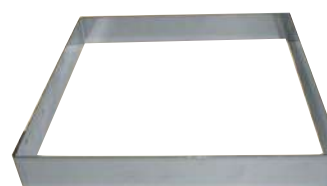

Stainless Steel Ring



Tear Drop Comma Cake Ring 逗點式水滴鋼蛋糕圈

CODE	SIZE (Ø x h cm)
6222201	16 x 6
6222202	18 x 6
6222203	20 x 6

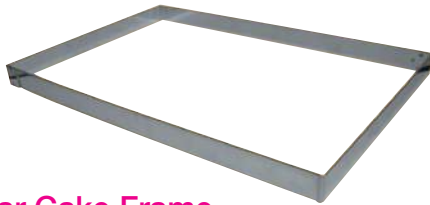

Rectangular Cake Frame 长方形鋼蛋糕圈

CODE	SIZE (l cm)	SPEC
6222402	57.0 x 37.0 x 2.5	Fit 40 x 60 Tray
6222404	57.0 x 37.0 x 3.5	Fit 40 x 60 Tray
6222408	57.0 x 37.0 x 6.0	Fit 40 x 60 Tray
6222410	49.5 x 29.0 x 4.5	Fit 1 / 1 GN Tray

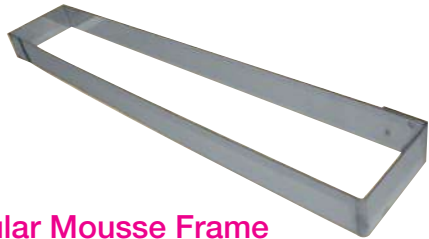

Rectangular Mousse Frame 长方形鋼慕斯圈

CODE	SIZE (l x w x h cm)	SPEC
6222303	57.0 x 9 x 3.5	Fit 40 x 60 Tray
6222305	57.0 x 9 x 4.5	Fit 40 x 60 Tray
6222308	57.0 x 11 x 3.5	Fit 40 x 60 Tray
6222310	57.0 x 11 x 4.5	Fit 40 x 60 Tray



Round Expandable Cake Ring 圓形鋼慕斯圈

CODE	SIZE (Ø x h cm)
6224301	18 to 34 x 5

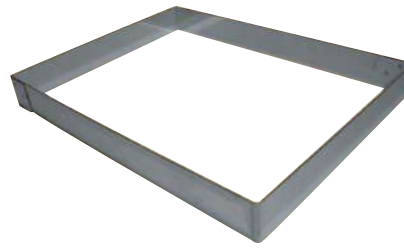

Rectangular Cadre Cake Frame 长方形鋼蛋糕圈

CODE	SIZE (l x w x h cm)
6222601	40 x 30 x 3.0
6222604	40 x 30 x 4.5

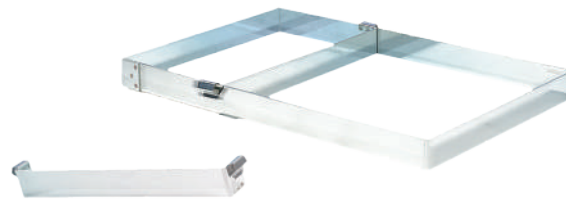

Short Dividing Strip 鋼分割条

CODE	SIZE (l x w cm)	SPEC
6222501	37 x 6.0	For 57 x 37 x 6 cm Cake Frame 6222408
6222509	29 x 4.5	For 49.5 x 29 x 4.5 cm Cake Frame 6222408



Rectangular Flan Frame 长方形鋼慕斯圈

CODE	SIZE (l x w x h cm)
6222902	50.0 x 11 x 2.5



Rectangular Expandable Cake Ring 长方形鋼慕斯圈

CODE	SIZE (l x w x h cm)
	Minimum Maximum
6224302	33 x 33 59 x 59

Stainless Steel Ring



Round Cake Ring

圓鋼圈

CODE	SIZE		REMARKS
	(Ø x h cm)	Inch	
6220505	12.7 x 5	5"	SN3227
6220506	15.2 x 5	6"	SN3243
6220507	17.8 x 5	7"	SN3244
6220508	20.3 x 5	8"	SN3245
6220509	22.9 x 5	9"	SN3246
6220510	25.4 x 5	10"	SN3247

Oblong Oval MOUSSE Ring

橢圓鋼慕斯圈

CODE	SIZE		REMARKS
	(l x w x h cm)	Inch	
6221106	15.2 x 11 x 5	6"	SN3363
6221108	20.3 x 11 x 5	8"	SN3365



Hexagon MOUSSE Ring

六角鋼慕斯圈

CODE	SIZE		REMARKS
	(Ø x h cm)	Inch	
6220906	15.2 x 5	6"	SN3323
6220908	20.3 x 5	8"	SN3325
6220910	25.4 x 5	10"	SN3327

Octagon MOUSSE Ring

八角鋼慕斯圈

CODE	SIZE		REMARKS
	(Ø x h cm)	Inch	
6221006	15.2 x 5	6"	SN3343
6221008	20.3 x 5	8"	SN3345
6221010	25.4 x 5	10"	SN3347



Triangle MOUSSE Ring

三角鋼慕斯圈

CODE	SIZE		REMARKS
	(Ø x h cm)	Inch	
6221206	13.1 x 5	6"	SN3283
6221208	17.5 x 5	8"	SN3285
6221210	22.0 x 5	10"	SN3287

Convex Triangle MOUSSE Ring

凸三角鋼慕斯圈

CODE	SIZE		REMARKS
	(l x w x h cm)	Inch	
6221301	13.1 x 12.2 x 5	6"	SN3463
6221302	17.4 x 16.3 x 5	8"	SN3465
6221303	21.8 x 20.4 x 5	10"	SN3467

Stainless Steel Ring



Square MOUSSE Ring 四方慕斯圈

CODE	SIZE		REMARKS
	(l x w x h cm)	Inch	
6221606	10.8 x 10.8 x 5	6"	SN3303
6221608	14.4 x 14.4 x 5	8"	SN3305
6221610	18.0 x 18.0 x 5	10"	SN3307



Heart Shape MOUSSE Ring 心型慕斯圈

CODE	SIZE		REMARKS
	(l x w x h cm)	Inch	
6221506	13.4 x 14.2 x 5	6"	SN3363
6221508	17.8 x 18.9 x 5	8"	SN3365
6221510	22.2 x 23.8 x 5	10"	SN3367



Tear Drop MOUSSE Ring 水滴型慕斯圈

CODE	SIZE		REMARKS
	(l x w x h cm)	Inch	
6221706	15.2 x 10.8 x 5	6"	SN3403
6221708	20.3 x 14.4 x 5	8"	SN3405
6221710	25.4 x 17.9 x 5	10"	SN3407



Plum Blossom MOUSSE Ring 梅花型慕斯圈

CODE	SIZE		REMARKS
	(l x w x h cm)	Inch	
6222106	15.2 x 5	6"	SN3523
6222108	20.3 x 5	8"	SN3525
6222110	25.4 x 5	10"	SN3527



Star MOUSSE Ring 星型慕斯圈

CODE	SIZE		REMARKS
	(Ø x h cm)	Inch	
6222006	15.2 x 5	6"	SN3503
6222008	20.3 x 5	8"	SN3505
6222010	25.4 x 5	10"	SN3507

Aluminium Rectangular Cake Frame 長方圈 (陽極)

CODE	SIZE		SPEC	REMARKS
	(l x w x h cm)	(mm)		
6222842	42.0 x 32.0 x 6		Fit 58.0 x 38.0 cm Tray	SN3385
6222855	54.5 x 34.5 x 6		Fit 60.0 x 40.0 cm Tray	SN3386
6222860	60.0 x 39.5 x 6		Fit 66.0 x 46.0 cm Tray	SN3387
6222861	61.0 x 38.0 x 6		Fit 67.5 x 43.5 cm Tray	SN3388

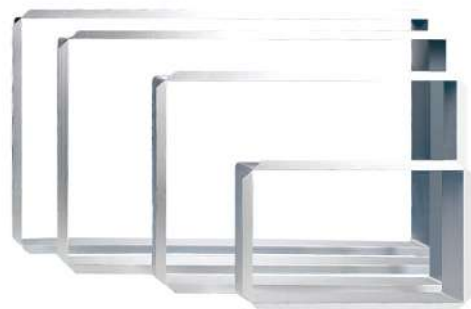

Stacking Frame Size 57 x 37 cm

Fit 60 x 40 cm Tray



Complete Set of Stacking Frame & Tray 可疊式蛋糕圈

CODE	SPEC
6222703	Complete with 10, 15 & 20mm Height Frame & Stainless Steel Tray

Individual Stacking Frame Only

CODE	SIZE (l x w cm)	SPEC
6222710	57 x 37 x 1.0	
6222715	57 x 37 x 1.5	
6222720	57 x 37 x 2.0	

Stainless Steel Tray Only for Stacking Frame

CODE	SIZE (l x w cm)	SPEC
6222701	60 x 40	

Regle Ruler only for Stacking Frame

CODE	SIZE (l x w cm)	SPEC
6222702	37	

Stainless Steel Small Cake Ring



Small Entremet Ring

小圓型圈

CODE	SIZE (Ø x h cm)	REMARKS
6224405	5.0 X 1.6	SN3211
6224406	6.0 X 1.6	SN3214
6224407	7.0 X 1.6	SN3216
6224408	8.0 X 2.0	SN3218
6224409	9.0 X 2.5	SN3220
6224410	10.0 X 2.0	SN3221



Small Entremet Ring

小圓型圈

CODE	SIZE (Ø x h cm)	REMARKS
6224504	4.5 X 2.0	SN3231
6224505	5.0 X 2.5	SN3232
6224506	6.0 X 3.0	SN3234



Small Frame Round Ring

小圓型圈

CODE	SIZE (Ø x h cm)	REMARKS
6222905	5.5 x 5	SN3473
6222906	6.0 x 5	SN3474
6222907	7.0 x 5	SN3476
6222908	8.0 x 5	SN3478
6222909	9.0 x 5	SN3480
6222910	10 x 5	SN3482



Small Frame Oblong Oval Ring

小橢圓圈

CODE	SIZE (l x w x h cm)	REMARKS
6223007	7 x 4.5 x 3.5	SN3256
6223009	9 x 6.0 x 4.0	SN3260



Small Frame Triangle Ring

小三角圈

CODE	SIZE (Ø x h cm)	REMARKS
6223155	5.5 x 4.9 x 3.0	SN3273
6223165	6.5 x 5.8 x 3.5	SN3275



Small Convex Triangle Ring

小凸三角圈

CODE	SIZE (l x w x h cm)	REMARKS
6223255	5.5 x 5.1 x 3.0	SN3453
6223265	6.5 x 6.1 x 3.5	SN3455



Small Frame Square Ring

小四方圈

CODE	SIZE (Ø x h cm)	REMARKS
6223355	5.5 x 3.0	SN3293
6223365	6.5 x 3.5	SN3295



Small Rectangle Ring

小方型圈

CODE	SIZE (l x w x h cm)	REMARKS
6224801	4.8 x 3.6 x 1.6	SN3373

Stainless Steel Small Cake Ring



Small Hexagon Ring
小六角圈

CODE	SIZE (Ø x h cm)	REMARKS
6223565	6.5 x 3.5	SN3315



Small Octagon Ring
小八角圈

CODE	SIZE (Ø x h cm)	REMARKS
6223665	6.5 x 3.5	SN3335



Small Heart Shape Ring
小心型圈

CODE	SIZE (l x w x h cm)	REMARKS
6223706	6.5 x 6.5 x 3.5	SN3355
6223707	7.5 x 7.5 x 3.5	SN3357



Small Teardrop Ring
小水滴圈

CODE	SIZE (l x w x h cm)	REMARKS
6223804	4.2 x 6 x 3	SN3394
6223805	5 x 7 x 3.5	SN3396



Small Comma Tear Drop Ring
逗點式水滴圈

CODE	SIZE (l x w x h cm)	REMARKS
6223907	7.6 x 5.3 x 4	SN3538



Small Star Ring
小星型圈

CODE	SIZE (Ø x h cm)	REMARKS
6224045	4.5 x 2.0	SN3491
6224055	5.5 x 3.0	SN3493
6224065	6.5 x 3.5	SN3495

Aluminium Mousse Ring Pad
(Hard Anodized)
慕斯圈墊片

CODE	SIZE (Ø cm)	REMARKS
6224225	25	SN3996





Small Entremet Ring

小圓型圈

CODE	SIZE (Ø x h cm)	THICKNESS (mm)
6224601	7.5 x 1.5	1.0 mm Thick



Thick Cake Ring

厚鋼蛋糕圈

CODE	SIZE (Ø x h cm)	THICKNESS (mm)
6224701	6.35 x 6.35	1 mm Thick
6224702	6.50 x 4.00	1 mm Thick
6224703	7.00 x 5.00	1 mm Thick



Square Thick Cake Ring

小方型圈

CODE	SIZE (l x w cm)	THICKNESS (mm)
6224901	6 x 6	1 mm Thick



Rectangular Thick Cake Ring

小方型圈

CODE	SIZE (l x w x h cm)	THICKNESS (mm)
6225002	9.5 x 4.0 x 2.2	1 mm Thick
6225005	9.5 x 4.0 x 5.0	1 mm Thick

Plastic MonoPortion Mould Size 60 x 40 x 4.3 cm

35 Portions Mould



Oval 椭圆形模具

CODE	MOULD SIZE (l x w x h cm)
6230235	8.2 x 5.0 x 4.0

Oval Extractor

CODE
6230235-R



Square 方形模具

CODE	MOULD SIZE (l x w x h cm)
6230335	5.8 x 5.8 x 4.0

Square Extractor

CODE
6230335-R



Round 圆形模具

CODE	MOULD SIZE (Ø x h cm)
6230535	6.5 x 4.0

Round Extractor

CODE
6230535-R



Teardrop 滴水形模具

CODE	MOULD SIZE (l x w x h cm)
6230435	9.2 x 6.3 x 4.0

Teardrop Extractor

CODE
6230435-R



Heart 心形模具

CODE	MOULD SIZE (l x w x h cm)
6230935	7.5 x 7.0 x 4.0

Heart Extractor

CODE
6230935 - R



Hexagon 六角形模具

CODE	MOULD SIZE (l x w x h cm)
6230735	6.3 x 6.3 x 4.0

Hexagon Extractor

CODE
6230735 - R



Slant Square 斜方形模具

CODE	MOULD SIZE (l x w x h cm)
6231135	9.8 x 6.7 x 4.0

Slant Square Extractor

CODE
6231135 - R



PASTRY

Plastic MonoPortion Mould Size 60 x 40 x 4.3 cm

96 Portions Mould

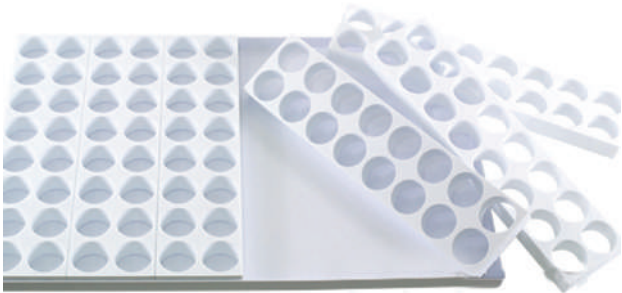

Oval 椭圆形模具

CODE	MOULD SIZE (l x w x h cm)
6230196	5.3 x 3.1 x 2.5

Oval Extractor

CODE
6230196 - R



Square 方形模具

CODE	MOULD SIZE (l x w x h cm)
6230396	3.5 x 3.5 x 4.0

Square Extractor

CODE
6230396 - R



Round 圆形模具

CODE	MOULD SIZE (Ø x h cm)
6230696	4.2 x 2.5

Round Extractor

CODE
6230696 - R



Teardrop 滴水形模具

CODE	MOULD SIZE (l x w x h cm)
6230496	5.5 x 3.5 x 2.5

Teardrop Extractor

CODE
6230496 - R



Heart 心形模具

CODE	MOULD SIZE (l x w x h cm)
6231096	5.0 x 4.4 x 2.5

Heart Extractor

CODE
6231096 - R



Hexagon 六角形模具

CODE	MOULD SIZE (l x w x h cm)
6230896	6.4 x 5.6 x 4.0

Hexagon Extractor

CODE
6230896 - R



Slant Square 斜方形模具

CODE	MOULD SIZE (l x w x h cm)
6231196	5.6 x 3.8 x 2.5

Slant Square Extractor

CODE
6231196 - R



Tinplated CROQUEMBOUCHE Mould 模具



CODE	SIZE (cm)
6241116	Base: ø 16 x HT: 30
6241120	Base: ø 20 x HT: 40
6241124	Base: ø 24 x HT: 50
6241128	Base: ø 28 x HT: 60



Aluminium Wedding Cake Stand 中柱型蛋糕塔



CODE	SPEC	REMARKS
6240108	6" ~ 20" 8 Tier	SN4434
6240110	6" ~ 24" 10 Tier	SN4433



Multiple Plastic Cake Display Stand 蛋糕塔



CODE	SPEC
6240204	ø 28cm Plate / 44cm Height 4 Tier



Multiple Plastic Cake Display Stand 蛋糕塔



CODE	SPEC
6240207	ø 28cm Plate / 75cm Height 7 Tier



Macarons Stand 蛋糕塔



CODE	SPEC
6240301	ø 33 cm Base Plate / 46 cm Height 10 Tier



Sugar Works

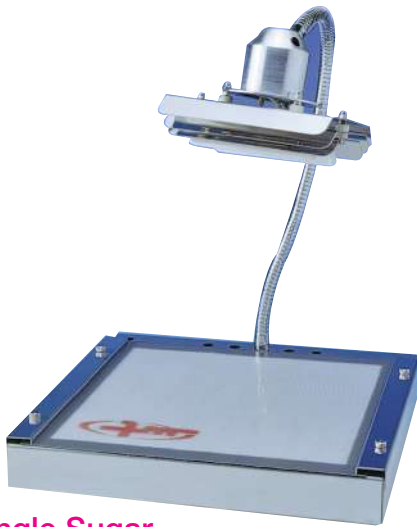

Electric Single Sugar Heating Lamp
糖加热灯管 (单灯)



CODE	SIZE (l x w cm)	SPEC
6260100	34 x 34	240V / 500W



Extra Long Latex Glove
特长乳胶手套



CODE	SIZE (l cm)
6260400	33.5



Rechargeable Gas Blow Torch
火枪



CODE
6260500



Protective Screen for Sugar Heating Lamp
保护屏



CODE	SIZE (l x w x h cm)
6260200	35.5 x 30 x 20



Rubber Sugar Pump
橡胶制糖泵



CODE
6260300



Blow Touch (Use With Cartridge Gas)
火枪



CODE
2310700



Gas Cartridge
瓶装煤气

CODE	CAP (ml)	SPEC
2310800	250	48 Cans / Ctn

Sugar Refractometer 糖度計



Master-53α

CODE	SPEC
6261602	BRIX: 0-90%



Master-53α

CODE	SPEC
6261601	BRIX: 0-53% (Automatic Temperature Compensation)

Digital Sugar Refractometer 糖度計



Pal-1

CODE	SPEC
6261603	BRIX: 0-53% Temperature: 9 to 99.9°C



Pal-2

CODE	SPEC
6261604	BRIX: 45-93% Temperature: 9 to 99.9°C



Pal-Patissier

CODE	SPEC
6261605	BRIX: 0-85% Temperature: 9 to 99.9°C Baume (sugar): 0 to 45°

Salt Refractometer 盐度計



Master-28

CODE	SPEC
6261801	Sodium chloride: 0 to 28g / 100g (Automatic Temperature Compensation)



Master-Bx / S28m

CODE	SPEC
6261701	Brix: 0.0 to 33.0% Sodium chloride: 0 to 28g / 100g



MASTER-Ramen

CODE	SPEC
6261902	Soup concentration 0 to 33% Kansui Baume 0 to 10 (automatic temperature correction)

Digital Salt Refractometer 盐度計



PAL-ES2

CODE	SPEC
6261803	0.00 to 5.00%



ES-421

CODE	SPEC
6261802	0.00 to 10.0%



DPH-2

CODE	SPEC
6261901	0.0 to 14.0 ph

PASTRY

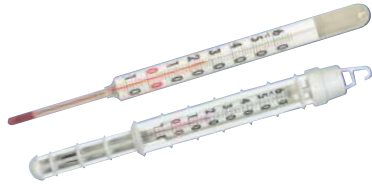

-10°C to + 60°C
Water Thermometer
 水温度计

CODE

6260900

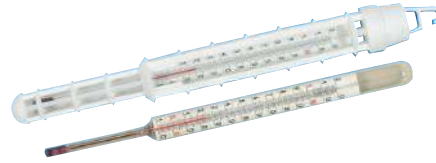

-10°C to + 120°C
Pate / Pork Thermometer
 猪肉温度计

CODE

6261000

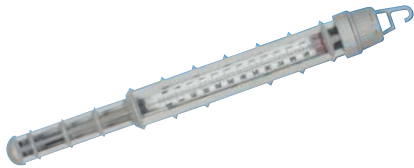

-80°C to +200°C
Sugar Thermometer
 糖浆温度计

CODE

6261100

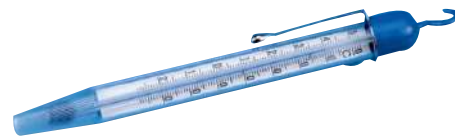

-20°C to + 50°C Dough Thermometer
 面团温度计

CODE

6261200



Syrup Density Meter Test Tube
 糖浆密度计试管

CODE	SIZE (cm)	CAP (ml)
6261400	ø 3 x HT: 25	100ml



Brine Density Meter
 盐水密度计

CODE

6261300



Chocolate Works



20 Prong Chocolate Fork
巧克力叉



CODE	SIZE (l x w cm)
6250101	16 x 7.5



17 Pcs Chocolate Stencils In Wooden Box
17粒装巧克力印花模 (不沾)



CODE	SIZE (l cm)
6250301	



Fiac-Prestige Oil-Free Compressor + 2M Airhose
压缩机

CODE	SPEC
6251001	Voltage : 220V Capacity : 6l Pressure Max : 8 Bar Dimension : 46.7 x 28 x 39 cm

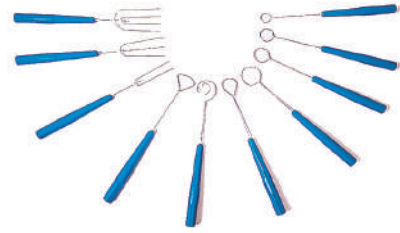

10 Pcs Set Stainless Steel Chocolate Dipping Fork
巧克力装饰插具 (10支组)



CODE	SIZE (l cm)
6250201	



Adjustable Colour Spray Gun
喷枪 (可调)



CODE	SIZE (l x h cm)	SPEC
6250801	15 x 14.5	0.3 mm Nozzle



Fix Colour Spray Gun
喷枪 (固定)



CODE	SIZE (l x h cm)	SPEC
6250901	14.7 x 7	0.3 mm Nozzle





Chocolate Spray Gun 巧克力喷枪

CODE	SPEC (mm)	SIZE (l cm)
6251101		

Spray Gun's Part

Nozzle 喷枪嘴



CODE	SPEC
6251204	No. 4
6251205	No. 6
6251206	No. 8

Flat Nozzle 喷枪嘴



CODE	SPEC
6251307	No. 7

Flexible Extension 喷枪延长



CODE
6251501

Angular Extension 喷枪延长(弯)



CODE
6251401



Cup With Lid 杯(有盖)

CODE	CAP (ml)
6251601	700



Electric Chocolate Tempering Machine, Air Heated 巧克力保温箱



CODE	SIZE (l x w x h cm)	SPEC	CAP (L)
6252120	67 x 38 x 22	240V / 600W	20



Electric Chocolate Tempering Machine, Air Heated 巧克力保温箱



CODE	SIZE (l x w x h cm)	SPEC	CAP (L)
6252112	49 x 38 x 22	240V / 500W	12.8



Electric Chocolate Tempering Machine 巧克力保温箱



CODE	CAP (L)
6252235	3.5



Manual Chocolate Shaver 手动巧克力刨



CODE	SIZE (l cm)
6251701	

Automatic Tempering Machines



- Microprocessor with digital temperature display
- Pedal to dose the chocolate
- Heated vibrating table



CW 24

Code	6253424
Voltage	400V / 3 phase
Power	4,100 Watt
Tank Capacity	24 L
Dimension	56 W x 75.6 D x 145.3 H cm
Weight	185 kg

Enrober

Enrober with double chocolate curtain, vibrating station, adjustable blowing unit, detailer, conveyor belt covered with paper (width 200 mm). The enrober automates the traditional, time-consuming coating of confectionery and fillings, increasing productivity and efficiency.

The thickness of the chocolate can be adjusted by the vibrating system (adjustable in intensity) and by the blowing unit (adjustable in height and intensity). At the end of the line, the product is placed on a conveyor belt covered with food-grade paper. The conveyor belt speed can be set by means of a regulator, adjusting the speed to the specific product and the number of employees.



M1300A

Code	6253401
Voltage	220V / single phase
Power	500 Watt
	(Electrical Connected to Tempering Machine)
Stored Dimension	50 W x 53 D x 175.5 H cm
Operational Dimension	174 W x 53 D x 126 H cm
Weight	72 kg

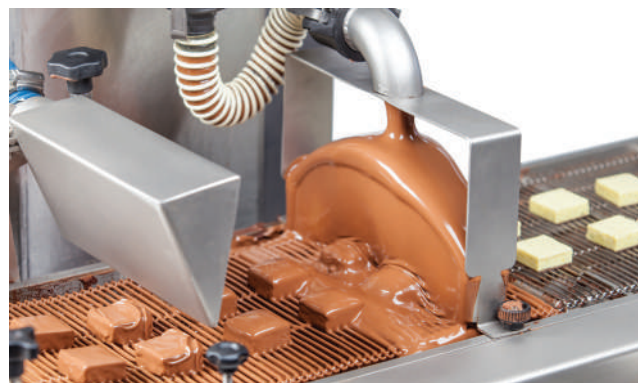

Panning Machine

Designed specifically to simplify the task of coating products such as hazelnuts, almonds, pistachio nuts, pine nuts, coffee grains, etc....

The panning machine is ideal for small to medium-scale operations. The unit is completely manufactured out of stainless steel and is equipped with an effective and silent speed control. The panning machine has been patented because of special features, which includes:

- its compact size and
- its special sphere mounting system

The panning machine is suitable for a variety of different applications and the speed with which the sphere can be replaced makes product processing and cleaning tasks SIMPLE and EASY.

The panning machine is equipped with an integrated high-performance fan and duct that feeds filtered air into the bowl when necessary.

The silicon cooling-air nozzle is movable and removable to facilitate the processing of the product in the tray.



M1291

Code	6253507
Voltage	230 - 240V / 50-60 Hz / single phase
Power	370 Watt
Capacity	7 L
Dimension	58 x 47 / 69 x 32 H cm



Chocolate Moulding Machine

The moulding machine with the best value: the M1276 tempers the melted chocolate by adding chocolate callets. The low investment makes this the ideal machine for professional production of a limited amount of chocolate.

M1276

Code	6253614
Voltage	230V / 50-60 Hz / single phase
Power	500 Watt Digital Thermostat
Capacity	14 Kg
Dimension	51 W x 56 D x 51 H cm
Weight	45 Kg



KALI Guitar Slicing Machine



Specifications

- Base and cutting arm in s/steel
- The arm sections are easily interchangeable, manufactured in s/steel, preventing water from entering during the washing ; providing perfect hygiene
- The arm cuts are easily interchangeable
- The wires are very robust and easy to assemble.
- Cutting surface of 360 x 360 mm plastic composite.
- For larger cuts, the wires can be removed depending on your cuts.

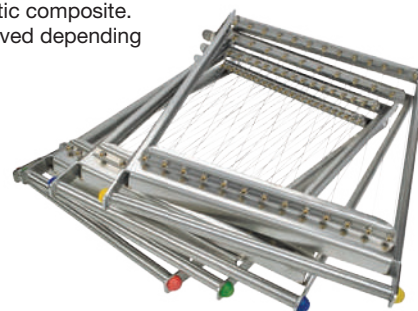

Simple Guitar Complete Set 切割框架

CODE	SIZE
	Base
6251801	63 x 47.5 cm
	Includes 3 removable stainless steel cutting frames: 15 mm spacing, 22.5 mm spacing, 30 mm spacing + 1 stainless steel spatula 360 x 360 mm and 3 extra wires

Guitar Cutting Frame 切割框架

CODE	SPEC (mm)	
6252001	15.0	spacing, Red
6252002	22.5	spacing, Green
6252003	30.0	spacing, Yellow
6252004	30.0	spacing, Blue

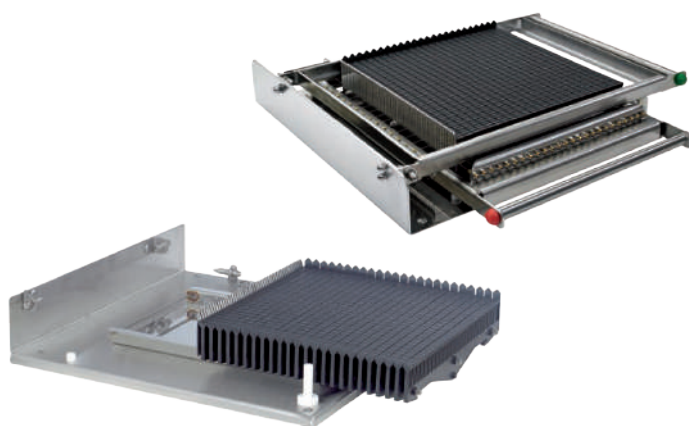

Double Guitar Base Only Without Cutting Frame 切割框架

CODE	SIZE
	Cutting Surface
6251901	36 x 36 cm

Special Square Size

6251902 22.5 x 22.5 cm

Surface only for double Guitar Special Square Size

6252300 22.5 x 22.5 cm



KALI Guitar Accessories



PE Transparent Sheet for Guitar Chocolate Work, 55 Micron



CODE	SIZE (cm)	SPEC (pcs)
6253100	40 x 60 cm	100 pcs / pkt

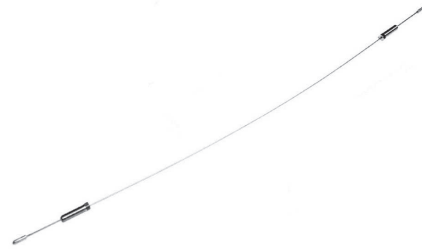

Stainless Steel Strings/ Cords for Kali Guitare



CODE	SIZE	SPEC (pcs)
6253200		

Frames Only for Guitar Slicing Machine



CODE	SIZE (l x w x h cm)
6253310	3.6 x 3.6 x 1.0
6253315	3.6 x 3.6 x 1.5

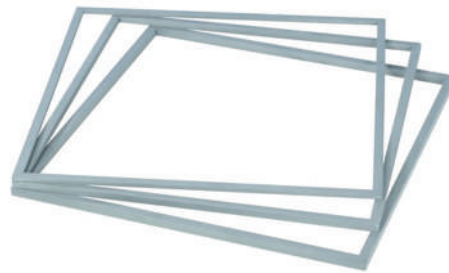

Series 1000 Chocolate Praline Mould

Size: 27.5 x 13.5 x 2.4 cm

巧克力模



Spheres

CODE	MOULD SPEC		REMARKS
	(Ø x h cm)	wt	
6270101	3 x 2.5	18 gr	CW1157



Spheres

CODE	MOULD SPEC		REMARKS
	(Ø x h cm)	wt	
6270201	3	2 x 9	CW1217



6270301



6270401



6270501

Heart

CODE	MOULD SPEC		REMARKS
	(Ø x h cm)	wt	
6270301	3.0 x 3.6 x 1.9	14 gr	CW1218
6270401	3.0 x 2.6 x 0.9	2 x 5 gr	CW1314
6270501	3.2 x 2.8 x 1.5	11 gr	CW1018



Double Heart

CODE	MOULD SPEC		REMARKS
	(Ø x h cm)	wt	
6270601	3 x 2.2 x 2	11 gr	CW1216



Chestnut

CODE	MOULD SPEC		REMARKS
	(Ø x h cm)	wt	
6270701	3.4 x 2.8 x 1.4	2 x 8 gr	CW1235



Wood Log

CODE	MOULD SPEC		REMARKS
	(Ø x h cm)	wt	
6270901	7.4 x 2 x 1.5	23 gr	CW1275



Autumn Nuts

CODE	MOULD SPEC		REMARKS
	(Ø x h cm)	wt	
6271801	5.8 x 2.1 x 0.9	2 x 6 gr	CW1498



Nuts

CODE	MOULD SPEC		REMARKS
	(Ø x h cm)	wt	
6270801	2.6 x 2.5 x 1.6	8 gr	CW1386



6271501



6271601

Coffee Bean

CODE	MOULD SPEC		REMARKS
	(Ø x h cm)	wt	
6271501	3.6 x 2.4 x 1.6	11 gr	CW1327
6271601	2.5 x 2.5 x 2.5	14 gr	CW1019



Rectangular Block

CODE	MOULD SPEC		REMARKS
	(Ø x h cm)	wt	
6271701	3.5 x 2.1 x 1.2	10 gr	CW1352

Series 1000 Chocolate Praline Mould

Size: 27.5 x 13.5 x 2.4 cm

巧克力模



Slop Square

CODE	MOULD SPEC (Ø x h cm)	wt	Portion	REMARKS
6272101	2.44 x 2.44 x 1.45	8 gr	3 x 7	CW1559



Slop Sphere

CODE	MOULD SPEC (Ø x h cm)	wt	Portion	REMARKS
6272201	2.75 x 2.75 x 1.49	7 gr	3 x 7	CW1561



Cilinder Met Gravure

CODE	MOULD SPEC (Ø x h cm)	wt	Portion	REMARKS
6272401	3.1 x 3.1 x 1.54	12 gr	3 x 7	CW1564



Round Waves

CODE	MOULD SPEC (Ø x h cm)	wt	Portion	REMARKS
6272601	2.5 x 2.5 x 1.6	7 gr	3 x 8	CW1605



Gems

CODE	MOULD SPEC (Ø x h cm)	wt	Portion	REMARKS
6272801	3.5 x 2 x 2.6	2 x 5 gr	3 x 8	CW1632



Cups

CODE	MOULD SPEC (Ø x h cm)	wt	Portion	REMARKS
6273001	3.5 x 2.6 x 1.9	14 gr	3 x 8	CW1003

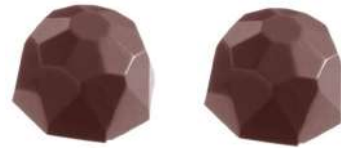

Diamond

6271901

6272001

CODE	MOULD SPEC (Ø x h cm)	wt	Portion	REMARKS
6271901	2.85 x 2.85 x 1.8	10 gr	3 x 8	CW1521
6272001	3.10 x 3.10 x 2.0	15 gr	3 x 7	CW1024



9 Bolletjes

CODE	MOULD SPEC (Ø x h cm)	wt	Portion	REMARKS
6272301	2.75 x 2.75 x 1.54	7 gr	3 x 7	CW1562



Middenstuk Trio

CODE	MOULD SPEC (Ø x h cm)	wt	Portion	REMARKS
6272501	2.9 x 2.9 x 1.5	8.5 gr	3 x 7	CW1603



100% Cacao Origin

CODE	MOULD SPEC (Ø x h cm)	wt	Portion	REMARKS
6272701	3 x 3 x 1.2	10 gr	3 x 7	CW1625



Cups

CODE	MOULD SPEC (Ø x h cm)	wt	Portion	REMARKS
6272901	3 x 1.9	14 gr	3 x 7	CW1002



Rose Shape

CODE	MOULD SPEC (Ø x h cm)	wt	Portion	REMARKS
6273101	2.7 x 2.7 x 1.6	9 gr	4 x 7	CW1544

Series 1000 Chocolate Praline Mould

Size: 27.5 x 13.5 x 2.4 cm

巧克力模



Gift box

CODE	MOULD SPEC (Ø x h cm)	wt	Portion	REMARKS
6273201	3.6 x 2.2 x 2	15 gr	3 x 8	CW1025



Cake

CODE	MOULD SPEC (Ø x h cm)	wt	Portion	REMARKS
6273301	3.9 x 2.8 x 1.7	13 gr	3 x 8	CW1029



Oval Strip

CODE	MOULD SPEC (Ø x h cm)	wt	Portion	REMARKS
6273401	3.7 x 2.3 x 2	17 gr	3 x 8	CW1031



Gift

CODE	MOULD SPEC (Ø x h cm)	wt	Portion	REMARKS
6273501	2.9 x 2.9 x 2	17 gr	3 x 8	CW1036



Curve Strip

CODE	MOULD SPEC (Ø x h cm)	wt	Portion	REMARKS
6273601	3 x 2.7 x 1.9	13 gr	3 x 8	CW1045



Triangle

CODE	MOULD SPEC (Ø x h cm)	wt	Portion	REMARKS
6273701	2.7 x 4.6 x 2.4	21 gr	4 x 5	CW1061



Pyramid Strip

CODE	MOULD SPEC (Ø x h cm)	wt	Portion	REMARKS
6273801	3.1 x 3.1 x 2.9	13 gr	3 x 7	CW1260



Bell

CODE	MOULD SPEC (Ø x h cm)	wt	Portion	REMARKS
6273901	3.1 x 2.7	12 gr	3 x 7	CW1047



Enrobed

CODE	MOULD SPEC (Ø x h cm)	wt	Portion	REMARKS
6274001	3.5 x 2.3 x 1.6	9 gr	3 x 8	CW1064



Egg

CODE	MOULD SPEC (Ø x h cm)	wt	Portion	REMARKS
6271001	4.3 x 3.0 x 1.4	2 x 12 gr	3 x 8	CW1317



Egg

CODE	MOULD SPEC (Ø x h cm)	wt	Portion	REMARKS
6271101	2.9 x 2.1 x 1.0	2 x 4 gr	5 x 7	CW1516



Egg

CODE	MOULD SPEC (Ø x h cm)	wt	Portion	REMARKS
6271201	3.3 x 2.3 x 1.2	5 gr	3 x 8	CW1582

Series 1000 Chocolate Praline Mould

Size: 27.5 x 13.5 x 2.4 cm

巧克力模



Egg

CODE	MOULD SPEC		REMARKS
	(Ø x h cm)	wt	
6271301	7.0 x 4.6 x 2.3	50 gr	2 x 4 CW1161



Egg

CODE	MOULD SPEC		REMARKS
	(Ø x h cm)	wt	
6271401	7.0 x 4.7 x 2.5	54 gr	2 x 4 CW1251

Series 2000 Chocolate Praline Mould

Size: 27.5 x 17.5 x 2.4 cm

巧克力模



Long Shape

CODE	MOULD SPEC		REMARKS
	(Ø x h cm)	wt	
6274201	4.8 x 1.8 x 2	13 gr	4 x 8 CW2138



Long Block

CODE	MOULD SPEC		REMARKS
	(l x w x h cm)	wt	
6274101	10 x 5 x 0.5	27 gr	2 x 3 CW2017



Spheres

CODE	MOULD SPEC		REMARKS
	(Ø x h cm)	wt	
6274301	3 x 1.9	14 gr	5 x 8 CW2207



Deep Sphere

CODE	MOULD SPEC		REMARKS
	(Ø x h cm)	wt	
6274401	2.9 x 2.1	13 gr	4 x 8 CW2295



Spheres

CODE	MOULD SPEC		REMARKS
	(Ø x h cm)	wt	
6270202	3.0	2 x 9 gr	5 x 8 CW2022



Spheres

CODE	MOULD SPEC		REMARKS
	(Ø x h cm)	wt	
6274501	5.0 x 2.5	2 x 40 gr	12 CW2251
6274601	5.9 x 2.9	2 x 71 gr	8 CW2252
6274701	8.0 x 4.0	2 x 162 gr	2 x 3 CW2254
6274702	7.0 x 3.5	2 x 113 gr	2 x 3 CW2253

E Series Egg Mould

Size: 17.5 x 27.5 cm
巧克力模



Egg Plain

CODE	MOULD SPEC (Ø x h cm)	REMARKS
6271002	23.0 x 15.5 x 7.5	E7001/230
6271003	32.0 x 22.0 x 11.0	E7001/320



Egg Strip

CODE	MOULD SPEC (Ø x h cm)	REMARKS
6275601	23.0 x 15.5 x 7.5	E7003/230
6275602	32.0 x 22.0 x 11.0	E7003/320

Hollow Figures Mould

巧克力模



Snow Man

CODE	SIZE (h cm)	Portion	REMARKS
6274920	20.4	1 x 1	H615



Santa Claus

CODE	SIZE (h cm)	Portion	REMARKS
6274814	14	1 x 1	H216
6274819	19	1 x 1	H215
6274826	26	1 x 1	H214



Ladies Shoe

CODE	SIZE (h cm)	Portion	REMARKS
6275112	12	1 x 1	H661017/B



Santa Boot

CODE	SIZE (h cm)	Portion	REMARKS
6275013	13	1 x 1	H407



Rabbit With Basket

CODE	SIZE		REMARKS
	(h cm)	Portion	
6275314	14.5	1 x 1	H120
6275319	19	1 x 1	H121



Bottles

CODE	SIZE		REMARKS
	(h cm)	Portion	
6275212	12.5	1 x 1	H152
6275225	25.2	1 x 1	H821



Standing Bunny

CODE	SIZE		REMARKS
	(h cm)	Portion	
6275517	17.5	1 x 1	H268
6275526	26.5	1 x 1	H250



Bunny in Easter Egg

CODE	SIZE		REMARKS
	(h cm)	Portion	
6275418	18	1 x 1	H901



Bell

CODE	SIZE		REMARKS
	(h cm)	Portion	
6275712	12	1 x 1	H511
6275716	16.5	1 x 1	H509



Halloween

CODE	SIZE		REMARKS
	(h cm)	Portion	
6275810	10.5	1 x 1	H928

Chinese Kitchen





Alum Yukihira Pan / Saucepan
铝单柄锅



CODE	SIZE (ø x h cm)
5010015	15 x 6.0
5010016	16 x 6.5
5010018	18 x 7.0
5010019	19 x 7.5
5010021	21 x 8.0
5010022	22 x 9.0
5010024	24 x 9.5
5010027	27 x 10.5
5010028	28 x 11.0
5010030	30 x 11.5



Alum Saucepan with Wooden Handle
铝单柄锅

CODE	SIZE (ø x h cm)
5010116	16 x 6.7
5010118	18 x 7.5
5010120	20 x 8.0
5010122	22 x 8.0
5010124	24 x 8.5



Square Copper Tamago Pan
方形铜平底煎锅

CODE	SIZE (l x w cm)
5010218	18 x 18
5010221	21 x 21
5010224	24 x 24



Rectangular Copper Tamago Pan
长形铜平底煎锅

CODE	SIZE (l x w cm)
5010313	18.0 x 13.5
5010315	19.5 x 15.0
5010316	21.0 x 16.5



Stainless Steel Stock Pot
(Flexible Handle)
高身有盖不锈钢桶 (活耳)

CODE	SIZE (ø x h cm)	CAP (L)
5010625	25 x 30	14.7
5010630	30 x 40	28.0
5010636	36 x 50	48.0
5010640	40 x 55	69.0
5010641	40 x 65	103.0
5010646	46 x 65	108.0



Stainless Steel Cooking Pot
高身有盖不锈钢桶

CODE	SIZE (ø x h cm)	CAP (L)
5010525	25 x 27	13.3
5010528	28 x 30	18.5
5010532	30 x 32	22.6
5010535	36 x 40	40.7
5010540	40 x 46	57.8
5010545	46 x 50	83.0
5010550	50 x 60	117.8
5010555	55 x 70	166
5010560	60 x 70	198
5010561	60 x 80	226
5010570	70 x 70	269
5010580	80 x 80	400



Stainless Steel Pot
(Graduated)
圆形有盖不锈钢桶 (带容量表)

GOURMET
STEEL

CODE	SIZE (ø x h cm)	CAP (L)
5010822	22 x 22	8
5010824	24 x 24	11
5010826	26 x 26	13
5010828	28 x 28	16
5010830	30 x 30	21
5010833	33 x 33	28
5010836	36 x 36	36
5010840	40 x 40	55
5010842	42 x 42	58
5010848	48 x 48	86
5010851	51 x 51	104
5010855	55 x 55	130
5010860	60 x 60	170



Stainless Steel Stackable Stock Pot
平盖不锈钢锅

CODE	SIZE (ø x h cm)	CAP (L)
5010728	28 x 28	17.0
5010730	30 x 30	21.0
5010733	32 x 32	28.0
5010736	35 x 35	33.5
5010740	40 x 40	50.0
5010745	45 x 45	71.5
5010750	50 x 50	98.0



Stainless Steel Casserole Sauce Pot
有盖不锈钢汁桶

CODE	SIZE (ø x h cm)	CAP (L)
5010930	30 x 17	12.0
5010936	36 x 20	20.4
5010940	40 x 23	29.0
5010945	45 x 25	40.0
5010950	50 x 28	55.0
5010955	55 x 33	78.4
5010960	60 x 36	102.0
5010970	70 x 43	165.5



Stainless Steel Hanging Pot
有盖高身不锈钢提桶

CODE	SIZE (ø x h cm)	CAP (L)
5011020	20 x 22	7.0
5011023	23 x 25	10.4
5011025	25 x 27	13.3
5011028	28 x 30	18.5
5011030	30 x 32	22.6
5011032	32 x 35	28.0
5011035	35 x 37	35.6
5011040	40 x 45	56.6



Stainless Steel Footed Hanging Pot
不锈钢提桶

CODE	SIZE (ø x h cm)	CAP (L)
5014020	20 x 22	6.9
5014022	22 x 25	9.5
5014025	25 x 27	13.0
5014028	28 x 30	18.0
5014030	30 x 32	22.0
5014032	32 x 35	28.0
5014035	35 x 37	35.5
5014040	40 x 45	56.0



Traditional Soup Pot
(Sandwich Base)
钢复底牛头煲

CODE	SIZE (ø x h cm)
5014120	20 x 20
5014125	25 x 25
5014130	30 x 30
5014135	35 x 35
5014140	40 x 40
5014145	45 x 45



Stainless Steel Insulated Pot
钢双耳保温桶

CODE	SIZE (ø x h cm)	CAP (L)
5011230	30 x 30	20



Stainless Steel Insulated Hanging Pot
有盖钢保温吊桶

CODE	SIZE (ø x h cm)
5014201	30 x 30
5014202	30 x 38
5014203	33 x 37
5014204	38 x 50
5014205	38 x 38



Stainless Steel Insulated Pot
不锈钢保温转运饭桶

CODE	SIZE (ø x h cm)	CAP (L)
5011333	33 x 22.5	15



Stainless Steel Insulated Barrel
不锈钢保温转运茶桶 (折叠单咀)

CODE	SIZE (ø x h cm)	CAP (L)
5011420	33 x 38	20
5011435	33 x 58	35



Stand For Insulated Barrel
不锈钢保温转运茶桶架

CODE	SIZE (ø x h cm)
5014335	35.5 x 13



Stainless Steel Square Deep Kitchen Pot
双耳不锈钢桶

CODE	SIZE (ø cm)	SPEC (L)
1120208	8	0.46
1120210	10	0.9
1120212	12	1.6
1120214	14	2.5
1120216	16	3.7
1120218	18	5.5
1120220	20	7.5
1120222	22	10.3
1120224	24	13.7
1120227	27	19
1120230	30	26



Stainless Steel Bean Curd Jelly Pail
不锈钢豆腐花桶

CODE	SIZE (ø x h cm)	CAP (L)
5011510	26 x 26	10
5011515	29 x 29	15
5011520	32 x 32	20
5011528	35 x 35	28
5011545	41 x 41	45



Stainless Steel Kitchen Stock Pot
双耳不锈钢桶



CODE	SIZE (ø cm)	CAP (L)
5011720	20	6.2
5011733	33	28.2
5011740	40	50.2
5011745	45	70.0
5011760	60	173.0



Stainless Steel Indian Pot with Cover
钢有盖印度锅

CODE	SIZE (ø cm)
5013718	18
5013720	20
5013722	22
5013724	24
5013726	26
5013728	28
5013730	30
5013732	32
5013734	34



Stainless Steel Double Handle Pot
双耳不锈钢锅

CODE	SIZE (ø cm)	CAP (L)
5011618	18	2.5
5011620	20	3.5
5011622	22	4.6
5011624	24	6.0
5011626	26	7.7
5011628	28	9.5
5011630	30	12.0
5011632	32	14.5
5011634	34	17.3
5011636	36	21.4



Aluminium Degchi / Indian Pot
铝印度锅

CODE	SIZE (ø cm)
5011830	30
5011832	32
5011834	34
5011836	36
5011838	38
5011840	40
5011842	42
5011844	44
5011846	46
5011848	48
5011850	50
5011855	55
5011860	60



Thick Aluminium Degchi / Indian Pot
厚铝印度锅

CODE	SIZE (ø cm)	
5011950	50	
5011955	55	
5011960	60	
5011965	65	
5011970	70	
5011975	75	
5011980	80	
5011985	85	
5012080	80	4 Handle
5012085	85	4 Handle



Commercial Pressure Cooker
气压锅

CODE	CAP (L)
5013807	7
5013815	15



Commercial Pressure Cooker
气压锅

CODE	CAP (L)
5013825	25
5013835	35



Aluminium Pressure Cooker
钢气压锅

CODE	CAP (L)
5012118	18
5012130	30
5012136	36
5012150	50



Aluminium Pressure Cooker
铝气压锅

CODE	SIZE (ø cm)
5013908	8
5013910	10
5013911	11



HK Iron Chinese Wok
香港手工铁锅

CODE	SIZE	
	(ø cm)	inch
5012314	35.5	14
5012315	38.0	15
5012316	40.6	16
5012318	45.7	18
5012319	48.0	19
5012320	50.8	20
5012322	55.8	22
5012324	60.9	24
5012326	66.0	26
5012328	71.0	28
5012330	76.0	30
5012332	81.0	32



HK Iron Chinese Wok
香港手工铁锅

陳枝記

CODE	SIZE	
	(ø cm)	inch
5013016	40.6	16
5013018	45.7	18
5013019	48.0	19
5013020	50.8	20
5013022	55.8	22
5013024	60.9	24
5013026	66.0	26
5013028	71.0	28
5013030	76.0	30
5013032	81.0	32



Iron Deep Wok with One Handle, Local
单柄深铁锅

CODE	SIZE	
	(ø cm)	inch
5012511	27.9	11
5012512	30.4	12
5012513	33.0	13
5012514	35.5	14
5012515	38.0	15
5012516	40.6	16
5012517	43.0	17
5012518	45.7	18



Iron Deep Chinese Wok, Local (Thick)
深厚铁锅

CODE	SIZE	
	(ø cm)	inch
5012212	30.0	12
5012213	33.0	13
5012214	35.5	14
5012215	38.0	15
5012216	40.6	16
5012217	43.0	17
5012218	45.7	18
5012220	50.8	20
5012222	55.8	22
5012224	60.9	24
5012226	66.0	26
5012228	71.0	28

HK Iron Wok with One Wooden Handle
香港单柄铁锅

CODE	SIZE	
	(ø cm)	inch
5012613	33.0	13
5012614	35.5	14
5012615	38.0	15
5012616	40.6	16





**Stainless Steel Hand Made
Chinese Wok**
不锈钢单柄炒锅

CODE	SIZE	
	(ø cm)	inch
5013211	28.0	11
5013212	30.4	12
5013213	33.0	13
5013214	35.5	14
5013215	38.0	15
5013216	40.6	16



**Stainless Steel Hand Made
Chinese Wok**
不锈钢炒锅

CODE	SIZE	
	(ø cm)	inch
5013110	25.4	10
5013112	35.5	12
5013113	33.0	13
5013114	35.5	14
5013115	38.0	15
5013116	40.6	16
5013117	43.0	17
5013118	45.7	18
5013119	48.2	19
5013120	50.8	20
5013122	55.8	22
5013124	60.9	24
5013126	66.0	26
5013128	71.0	28
5013130	76.2	30



Iron Flat Prata Pan with Rim
有边生铁锅

CODE	SIZE	
	(ø cm)	inch
5013608	20.3	8
5013609	22.8	9
5013610	25.4	10
5013611	27.9	11
5013612	30.4	12
5013613	33.0	13
5013614	35.5	14
5013615	38.0	15
5013616	40.6	16
5013617	43.0	17
5013618	45.7	18
5013619	48.0	19
5013620	50.8	20
5013621	53.3	21
5013622	55.8	22
5013623	58.4	23
5013624	60.9	24
5013625	63.5	25
5013626	66.0	26
5013627	68.5	27
5013628	71.1	28



Stainless Steel Double Ring Wok Stand
不锈钢双圈锅架 / 脚

陳枝記

CODE	SIZE	
	(ø cm)	
5012900	27.9	



Wooden Wok Hammer
木锅柄

CODE	SIZE	
	(l cm)	inch
5013301	35.5	14



Bamboo Wok Brush
竹锅刷

CODE	SIZE	
	(l cm)	inch
5013500	25	10



Bamboo Wok Brush
竹锅刷

陳枝記

CODE	SIZE	
	(l cm)	inch
5013400	25	10



Stainless Steel Wire Strainer
不锈钢竹柄罩厘

陳枝記

CODE	SIZE	
	(ø cm)	inch
5020208	20.3	8
5020209	23.0	9
5020210	25.4	10
5020211	27.9	11
5020212	30.4	12



Stainless Steel Wire Strainer
不锈钢竹柄罩厘

CODE	SIZE	
	(ø cm)	inch
5020105	12.7	5
5020106	15.0	6
5020107	17.7	7
5020108	20.3	8
5020109	22.8	9
5020110	25.4	10
5020111	27.9	11
5020112	30.4	12
5020113	33.0	13



Stainless Steel Wire Strainer
不锈钢罩厘

陳枝記

CODE	SIZE	
	(ø cm)	inch
5022910	25.4	10
5022911	27.9	11
5022912	30.4	12
5022914	35.5	14
5022916	40.6	16



Iron Big Hole Strainer
竹柄铁大洞炸厘

CODE	SIZE	
	(ø cm)	inch
5020305	12.7	5
5020306	15.0	6
5020307	17.7	7
5020308	20.3	8
5020309	22.8	9
5020310	25.4	10
5020311	27.9	11
5020312	30.4	12
5020313	33.0	13
5020314	35.5	14
5020315	38.0	15



Copper Wire Strainer
竹柄铜炸厘

CODE	SIZE	
	(ø cm)	inch
5020405	12.7	5
5020406	15.0	6
5020407	17.7	7
5020408	20.3	8
5020409	22.8	9
5020410	25.4	10
5020411	27.9	11
5020412	30.4	12
5020413	33.0	13
5020414	35.5	14



Stainless Steel Fine Wire Strainer
不锈钢炸厘

CODE	SIZE	
	(ø cm)	inch
5023008	20.3	8
5023009	22.8	9
5023010	25.4	10
5023011	27.9	11
5023012	30.4	12
5023013	33.0	13



Stainless Steel Fine Mesh Strainer
不锈钢竹柄隔油厘

CODE	SIZE	
	(ø cm)	inch
5020508	20.3	8
5020509	22.8	9
5020510	25.4	10
5020511	27.9	11
5020512	30.4	12



Stainless Steel Fine Mesh Strainer
不锈钢竹柄密油厘 **陳枝記**

CODE	SIZE	
	(ø cm)	inch
5020609	22.8	9
5020610	25.4	10
5020611	27.9	11
5020612	30.4	12



陳枝記
Stainless Steel Square Net Strainer
竹柄钢方格洞炸厘

CODE	SIZE	
	(ø cm)	inch
5020809	22.8	9
5020810	25.4	10
5020811	27.9	11
5020812	30.4	12



Stainless Steel Fine Mesh Strainer
不锈钢密油筛 **陳枝記**

CODE	SIZE	
	(ø cm)	inch
5023110	25.4	10
5023111	27.9	11
5023112	30.4	12



Stainless Steel Square Net Strainer
竹柄钢方格洞炸厘

CODE	SIZE	
	(ø cm)	inch
5023310	25.4	10
5023311	27.9	11
5023312	30.4	12
5023313	33.0	13



Stainless Steel Fine Mesh Strainer
不锈钢密油筛

CODE	SIZE	
	(ø cm)	inch
5023207	17.7	7
5023208	20.3	8
5023209	22.8	9
5023210	25.4	10
5023211	27.9	11
5023212	30.4	12



Stainless Steel Square Net Strainer
不锈钢方格洞炸厘

CODE	SIZE	
	(ø cm)	inch
5023507	17.7	7
5023508	20.3	8
5023509	24.0	9.5
5023510	25.4	10
5023511	27.9	11
5023512	30.4	12



Stainless Steel Double Net Strainer
双层幼网不锈钢炸厘

CODE	SIZE	
	(ø cm)	inch
5023608	20.3	8
5023609	22.8	9
5023610	25.4	10
5023611	27.9	11
5023612	30.4	12
5023613	33.0	13



Stainless Steel Wire Noodle Strainer
竹柄钢面厘

CODE	SIZE	
	(ø cm)	inch
5020960	15.0	6.0
5020965	16.5	6.5



Stainless Steel Square Net Strainer
木柄不锈钢方格洞炸厘

CODE	SIZE	
	(ø cm)	inch
5023708	26	8
5023709	29	9
5023710	32	10



Stainless Steel Oil Skimmer
全不锈钢炸壳

CODE	SIZE	
	(ø cm)	inch
5021020	20	8.0
5021024	24	9.5
5021026	26	10
5021030	30	12



Stainless Steel 1 Pc Oil Skimmer
不锈钢炸壳

陳枝記

CODE	SIZE	
	(ø cm)	inch
5022609	22.8	9
5022610	25.0	10
5022611	27.9	11
5022612	30.4	12



Stainless Steel Oil Skimmer
木柄不锈钢炸壳

CODE	SIZE	
	(ø cm)	inch
5022808	20.0	8
5022809	22.8	9
5022810	25.0	10
5022811	27.9	11
5022812	30.4	12



Stainless Steel Skimmer Ring
不锈钢炸壳架

CODE	SIZE	
	(ø cm)	inch
5021107	17.7	7



**Stainless Steel Deep Fry
Chicken Basket**
不锈钢双耳炸鸡篮

陳枝記

CODE	SIZE	
	(ø cm)	inch
5021224	60.9	24



Stainless Steel Bird Nest Fryer
油炸鸟巢网

CODE	SIZE
	(ø cm)
2090612	12



Stainless Steel Bird Nest Fryer
不锈钢油炸鸟巢网

CODE	SIZE	
	(ø cm)	inch
2090709	9	3.5
2090713	13	5.0
2090717	17	6.5



Nylon Soup Bag
煲汤袋

CODE	SIZE	
	(l cm)	inch
5021400	25.4 x 30.4	10 x 12



Cotton Soup Bag with String
布煲汤袋

CODE	SIZE	
	(ø cm)	inch
5021500	35.5 x 38	14 x 15



Coconut Cloth Bag with String
布椰子袋

CODE	SIZE	
	(l cm)	inch
5022700		



Stainless Steel Soup Basket
不锈钢汤篮

CODE	SIZE	
	(ø cm)	inch
5021604	10.0	4
5021605	12.7	5
5021606	15.0	6
5021607	17.7	7
5021608	20.3	8
5021609	22.8	9
5021610	25.4	10
5021611	27.9	11
5021612	30.4	12



Nylon Fish Net with Alum Handle
铝柄鱼网 陳枝記

CODE	SIZE	
	(l cm)	(Inch)
5021701	35.5	14
5021702	30.4	12
5021703	25.4	10



Stainless Steel Chinese Turner
木柄不锈钢锅铲

CODE	SIZE	TYPE
	(l cm)	
5021803	10.0	3
5021802	11.0	2
5021801	11.6	L
5021810	12.7	XL
5021811	13.0	XXL



Stainless Steel Chinese Turner
全钢锅铲

CODE	SIZE (l cm)	TYPE
5022111	11	2
5022112	12	L
5022113	13	XL
5022114	14	XXL



Stainless Steel Chinese Turner
木柄不锈钢锅铲 **陳枝記**

CODE	TYPE
5021903	3
5021902	2
5021901	L
5021911	XL



Stainless Steel Chinese Ladle
木柄不锈钢炒壳

CODE	SIZE (l cm)	CAP tael (leung)
5022204	11.0 x 9.0	4
5022206	12.0 x 10.5	6
5022208	13.0 x 11.5	8
5022210	13.7 x 11.6	10
5022212	15.2 x 12.7	12
5022214	16.0 x 14.5	14
5022216	16.5 x 14.5	16



Stainless Steel Chinese Ladle
全钢炒壳

CODE	SIZE (l cm)	CAP tael (leung)
5022406		6
5022408		8
5022410		10
5022412		12



Stainless Steel 1-Pcs Chinese Turner
全钢锅铲

CODE	SIZE (l cm)	inch
5022032	81	32
5022048	122	48



Stainless Steel Chinese Ladle
木柄钢炒壳 **陳枝記**

CODE	SIZE (l cm)	CAP tael (leung)
5022504		4
5022506	12	6
5022508	13	8
5022510	13.5	10
5022512	14	12



Stainless Steel 1-Pcs Turner
全钢锅铲

CODE	SIZE (w x l cm)
5023845	16 x 45
5023860	16 x 60
5023880	16 x 80



Stainless Steel Chinese Ladle
全钢长柄炒壳

CODE	SIZE (ø x l cm)
5022330	18 x 30
5022360	16 x 60
5022380	80



Stainless Steel Round Steam Rice Pan
圆形钢糕盆

CODE	SIZE (ø cm)	inch
5030117	43.2	17
5030118	45.7	18
Perforated		
5030217	43.2	17



Aluminium Steam Pan
铝糕盆

CODE	SIZE (ø cm)
5031838	38
5031840	40
5031842	42
5031846	46
5031850	50



Stainless Steel Mar Bowl
不锈钢马碗

CODE	SIZE (ø cm)
5030412	12
5030414	14
5030416	16
5030418	18
5030420	20
5030422	22



H.K Style Stainless Steel Deep Mar Bowl
港式深钢马碗

CODE	SIZE (ø cm)
5031910	10
5031912	12
5031914	14
5031916	16
5031918	18
5031920	20
5031922	22
5031924	24



Stainless Steel Bird Nest Mar Bowl
不锈钢鸟巢碗

CODE	SIZE (ø cm)
5030514	14
5030516	16
5030518	18
5030520	20



Stainless Steel X-Thick Mixing Bowl
不锈钢加厚搅拌碗

CODE	SIZE (ø cm)	CODE	SIZE (ø cm)
2060515	15	2060536	36
2060518	18	2060539	39
2060521	21	2060542	42
2060524	24	2060545	45
2060527	27	2060550	50
2060530	30	2060555	55
2060533	33	2060560	60

CHINESE KITCHEN



Stainless Steel Deep Mar Plate
不锈钢马碟

CODE	SIZE (ø cm)	CODE	SIZE (ø cm)
5030814	14	5030822	22
5030816	16	5030824	24
5030818	18	5030826	26
5030820	20	5030828	28



Stainless Steel Oil / Sauce Container
不锈钢油斗

CODE	SIZE (ø cm)
5030910	10
5030912	12
5030914	14
5030916	16
5030918	18
5030920	20
5030922	22



5030605

5030604

Stainless Steel Double Boil Bowl
不锈钢炖汤碗

CODE	SIZE (ø cm)	inch
5030604	11.4	4.5
5030605	12.7	5.0



Stainless Steel Square Oil / Sauce Container
方形无盖酱料盒

CODE	SIZE (l x w cm)
5031010	10 x 10
5031012	12 x 12
5031015	15 x 15
5031018	18 x 18
5031020	20 x 20



Stainless Steel Utility Deep Mixing Bowl
钢深型物料盆

CODE	SIZE (ø cm)	CODE	SIZE (ø cm)
2060612	12	2060626	26
2060614	14	2060628	28
2060616	16	2060630	30
2060618	18	2060632	32
2060620	20	2060634	34
2060622	22	2060636	36
2060624	24	2060638	38



Stainless Steel Oil Container Cover
不锈钢油斗

CODE	SIZE (ø cm)
5032110	10
5032112	12
5032114	14
5032116	16
5032118	18
5032120	20



Stainless Steel Oil Pot
不锈钢油桶

CODE	SIZE (ø cm)	(inch)
5032009	22.8	9
5032010	25.4	10
5032011	27.9	11



Stainless Steel Oil Pot
直身不锈钢油桶

CODE	SIZE (ø cm)
5031609	22
5031610	24
5031611	26



Stainless Steel Oil Decanter ('TRI' Spout)
钢麻油(尖咀)

CODE	SIZE (l cm)
5031208	8
5031209	9
5031211	11



Stainless Steel Oil Decanter ('O' Spout)
钢紹酒壺(圓咀)

CODE	SIZE (l cm)
5031108	8
5031109	9
5031111	11

Stainless Steel Condiment Shaker
不锈钢调味料罐



Sesame 芝麻

CODE	SIZE (ø x h cm)	CAP (cc)
2050500	7.5 x 9.0	300
2050600	7.5 x 13.5	500



Pepper 胡椒

CODE	SIZE (ø x h cm)	CAP (cc)
2050501	7.5 x 9.0	300
2050601	7.5 x 13.5	500



Salt 盐

CODE	SIZE (ø x h cm)	CAP (cc)
2050502	7.5 x 9.0	300
2050602	7.5 x 13.5	500

Stainless Steel Shaker (Mesh)
不锈钢密洞糖粉罐



CODE	CAP (cc)
2050715	150
2050730	300

Stainless Steel Condiment Shaker
不锈钢调味料罐



Pepper 胡椒

CODE	CAP (cc)
2050115	150
2050133	330
2050150	500



Salt 盐

CODE	CAP (cc)
2050215	150
2050233	330
2050250	500



Sesame 芝麻

CODE	CAP (cc)
2050315	150
2050333	330
2050350	500



Stainless Steel Steamer Cover
不锈钢蒸笼盖

CODE	SIZE	
	(ø x h cm)	(ø x h inch)
5041109	24.0 x 6.0	9 x 2.36
5041110	26.0 x 6.0	10 x 2.36
5041111	28.0 x 7.5	11 x 2.95
5041112	30.0 x 7.0	12 x 2.75
5041113	33.0 x 7.0	13 x 2.75
5041114	35.5 x 9.0	14 x 3.54
5041116	40.6 x 8.5	16 x 3.42
5041118	45.7 x 10	18 x 3.93



Stainless Steel Steamer (Fixed Base)
不锈钢蒸笼 (连底)

CODE	SIZE	
	(ø x h cm)	(ø x h inch)
5040109	24.0 x 7.8	9 x 3.07
5040110	26.0 x 8.0	10 x 3.15
5040111	28.0 x 9.5	11 x 3.74
5040112	30.0 x 9.0	12 x 3.54
5040113	33.0 x 9.5	13 x 3.74
5040114	35.5 x 10.5	14 x 4.13
5040116	40.6 x 10.8	16 x 4.25
5040118	45.7 x 12.4	18 x 4.88



Stainless Steel Steamer
(Fixed Holes Base)
不锈钢蒸笼 (连底)

CODE	SIZE	
	(ø x h cm)	(ø x h inch)
5040301	40.6 x 12.7	16 x 5
5040302	45.7 x 12.7	18 x 5
5040303	52.0 x 15.0	20 x 6
5040304	52.0 x 15.0	20 x 6
5040305	52.0 x 25.4	20 x 10
5040306	55.8 x 25.4	22 x 10



Stainless Steel Steamer
(Fixed Stripes Base)
不锈钢钢蒸笼 (连底)

CODE	SIZE	
	(ø x h cm)	(ø x h inch)
5040201	52.0 x 10.0	20 x 4
5040202	52.0 x 12.7	20 x 5
5040203	52.0 x 15.0	20 x 6
5040204	52.0 x 25.4	20 x 10
5040205	55.8 x 12.7	22 x 5
5040206	55.8 x 15.0	22 x 6
5040207	55.8 x 20.3	22 x 8
5040208	55.8 x 25.4	22 x 10



Stainless Steel Steamer
(Removable Base)
不锈钢蒸笼 (活底)

CODE	SIZE	
	(ø x h cm)	(ø x h inch)
5040401	52.0 x 12.7	20 x 5
5040402	52.0 x 25.4	20 x 10
5040403	55.8 x 15.0	22 x 6
5040404	55.8 x 25.4	22 x 10



Stainless Steel Steamer Cover
不锈钢蒸笼盖

CODE	SIZE	
	(ø x h cm)	inch
5040501	50.8 x 10	20 x 4
5040502	50.8 x 15	20 x 6
5040503	55.8 x 10	22 x 4



Stainless Steel Square Steamer
不锈钢方形蒸笼

CODE	SIZE	
	(l cm)	inch
5040928	28 x 28	11.0
5040930	30 x 30	12.0
5040933	33 x 33	13.0
5040936	36 x 36	14.0
5040939	39 x 39	15.0
5040942	42 x 42	16.5
5040945	45 x 45	18.0
5040950	50 x 50	19.0
5040960	60 x 60	23.0



Stainless Steel Steam Water Pot
不锈钢水罉

CODE	SIZE	
	(ø outer x ø inner x h cm)	(inch)
5040713	33.0 x 30.4 x 30.4	13 x 12 x 12
5040715	38.0 x 30.4 x 30.4	15 x 12 x 12
5040716	40.6 x 30.4 x 30.4	16 x 12 x 12
5040718	45.7 x 35.5 x 35.5	18 x 14 x 14
5040722	55.8 x 35.5 x 35.5	22 x 14 x 14
Wide Inner Model		
5040814	35.5 x 30.4 x 30.4	14 x 12 x 12
5040816	40.6 x 30.4 x 30.4	16 x 12 x 12
5040818	45.7 x 30.4 x 30.4	18 x 12 x 12



Deluxe Bamboo Colander
日式竹筛

CODE	SIZE	
	(ø cm)	inch
5050209	22.8	9
5050211	27.9	11
5050214	35.5	14
5050217	43.2	17
5050220	50.8	20
5050224	60.9	24
5050227	68.5	27



Stainless Steel Round Steaming Ring
不锈钢蒸笼圈

CODE	SIZE	
	(ø cm)	inch
5040621	52.0	21
5040622	55.8	22



Square Bamboo Colander
方形竹筛

CODE	SIZE	
	(l cm)	inch
5050307	17.7	7
5050309	22.8	9
5050311	27.9	11
5050313	33.0	13
5050315	38.0	15
5050317	43.2	17

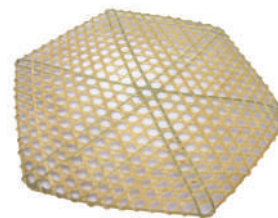

Bamboo Shark Fin Net
竹网

CODE	SIZE
	Holes
5051010	10
5051012	12



Bamboo Satay Stick (200'S)
竹签 (200支)

CODE	SIZE		REMARKS
	(l cm)	(inch)	
5050506	15.2	6"	200 pkt / ctn
5050507	17.7	7"	200 pkt / ctn
5050508	20.3	8"	200 pkt / ctn
5050510	25.4	10"	200 pkt / ctn
5050512	30.4	12"	200 pkt / ctn



Bamboo Chopstick (10-Pair)
竹筷 (10双)

CODE	SIZE
	(l cm)
5050401	25

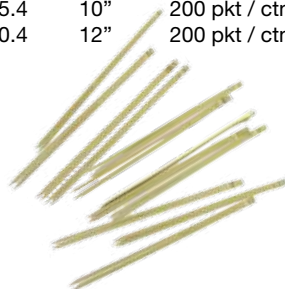

Flat Bamboo Pick (Split End)
“平”竹串

CODE	SIZE	
	(l cm)	pcs / pkt
5050714	10	100
5050715	9	100



End Knot Bamboo Pick
竹串

CODE	SIZE
	(l cm)
5050601	10



Wide End Bamboo Spear
竹矛

CODE	SIZE
	(l cm)
	7
5050816	9
5050817	15
5050819	24



Heart Shape Bamboo Pick
青竹心形串

CODE	SIZE
	(l cm)
5051209	9.0
5051212	12.0
5051215	15.0



Red / Black Flat Bead Bamboo Pick
黑/红扁珠竹针

CODE	SIZE
	(l cm)
5051010	10.0
5051012	12.5
5051015	15.0

Red Round Bead Bamboo Pick
红中珠竹针

CODE	SIZE
	(l cm)
5051110	10.0
5051112	12.0
5051115	15.0



Stainless Steel Tai Pin Slicing Knife
(Wooden Handle)
木柄鋼大片刀

CODE	SIZE (l cm)	Type
5060601	24 x 12.5	1
5060602	23 x 12	2
5060603	22.5 x 11.5	3



Tai Pin Slicing Knife (Wooden Handle)
鐵大片刀

CODE	SIZE (l cm)	Type
5060501	24.0 x 12.5	1
5060502	23.0 x 12.0	2
5060503	22.5 x 11.5	3



Iron Slicing Knife (Colour Handle)
膠柄鐵桑刀

CODE	SIZE (l cm)	Type
5060801-xx	24 x 10	1
5060802-xx	21 x 9.5	2

*Available Color

RD WH YE

When ordering Red Handle add **CODE** suffix to item number (example: 5060801-RD)



Iron Slicing Knife (Wooden Handle)
木柄鐵桑刀

CODE	SIZE (l cm)	Type
5060701	24 x 10	1
5060702	21 x 9.5	2



Stainless Steel Small Slicing Knife
(Colour Handle)
柄鋼小片刀

CODE	SIZE (l cm)	Type
5061901-xx	21.0 x 9.5	1
5061902-xx	20.5 x 9.0	2

*Available Color

RD WH GR BL YE BR

When ordering Red Handle add **CODE** suffix to item number (example: 5061901-RD)



Stainless Steel Small Slicing Knife
(Wooden Handle)
木柄鋼大片刀

CODE	SIZE (l cm)	Type
5062001	21 x 9.5	1
5062002	20.5 x 9	2

Stainless Steel Dough Pa Pei Knife
膠/木柄鋼拍皮刀

CODE	SIZE (l cm)	Type
5061101-02	20.5 x 9	1 Colour Handle
5061201	20.5 x 9	1 Wooden Handle





Stainless Steel Peking Duck Knife
(Wooden Handle)
木柄鋼片鴨刀

CODE	SIZE (l cm)
5060907	18.0 x 5
5060908	20.5 x 5



Stainless Steel Peking Duck Knife
(Colour Handle)
膠柄鋼片鴨刀

CODE	SIZE (l cm)
5061007-xx	18.0 x 5
5061008-xx	20.5 x 5

*Available Colour

■ RD □ WH ■ GR ■ BL

When ordering Red Handle add **CODE** suffix to item number
(example: 5061007-RD)



Butcher 'Pork' Knife (Wooden Handle)
木柄鐵豬肉刀

CODE	SIZE (l cm)	Type
5061301	28.0 x 15.0	1
5061302	27.5 x 14.5	2
5061303	26.5 x 14.0	3



Iron Thick Bone Cleaver Knife
(Wooden Handle)
木柄鐵骨刀

CODE	SIZE (l cm)	Type
5061601	23.5 x 10.5	1
5061602	22.5 x 10.0	2



Iron Thick Bone Cleaver Knife
(Colour Handle)
膠柄厚鐵骨刀

CODE	SIZE (l cm)	Type
5061701-xx	23.5 x 10.5	1
5061702-xx	22.5 x 10.0	2

*Available Colour

■ RD □ WH ■ BL

When ordering Red Handle add **CODE** suffix to item number (example: 5061701-RD)



Butcher 'MO' Knife (Colour Handle)
膠柄鐵毛刀

CODE	SIZE (l cm)	Type
5061501-xx		1

*Available Colour

■ RD □ WH

When ordering Red Handle add **CODE** suffix to item number
(example: 5061501-RD)



Stainless Steel Kow Kong Knife
(Wooden Handle)
木柄剛九江刀

CODE	SIZE (l x w cm)	Type
5062301	19 x 12	1
5062302	18 x 11	2
5062303	20 x 13	XL



Iron Kow Kong Knife (Colour Handle)
胶柄铁九江刀

CODE	SIZE (l x w cm)	Type
5060401-xx	19 x 12	1
5060402-xx	18 x 11	2
5060403-xx	20 x 13	3 XL

*Available Colour

BL WH

When ordering Blue Handle add **CODE** suffix to item number (example: 5060401-BL)



Iron Kow Kong Knife (Wooden Handle)
木柄铁九江刀

CODE	SIZE (l x w cm)	Type
5062601		1
5062602		2



Stainless Steel Bone Cleaver
(Wooden Handle)
木柄钢文武厨刀

CODE	SIZE (l x w cm)	Type
5061801		1
5061802		2



Full Stainless Steel Kow Kong Knife
全刚九江刀

CODE	SIZE (l x w cm)	Type
5062201	19 x 12	1
5062202	18 x 11	2



Iron Kow Kong Knife (Wooden Handle)
木柄铁九江刀

CODE	SIZE (l x w cm)	Type
5060301	19 x 12	1
5060302	18 x 11	2
5060303	20 x 13	3



Stainless Steel Vegetable Chop Knife
(Colour Handle)
胶柄钢菜刀

CODE	SIZE (l x w cm)	Type
5062401-xx	21.5 x 10	1
5062402-xx	21.0 x 9.5	2

*Available Colour

RD WH GR BL BR

When ordering Red Handle add **CODE** suffix to item number (example: 5062401-RD)



Stainless Steel Vegetable Chop Knife
(Wooden Handle)
木柄鋼菜刀

CODE	SIZE (l x w cm)	Type
5062501	21.5 x 10	1
5062502	21.0 x 9.5	2
5062503	20.5 x 9.0	3



Iron Siew Lap Knife
(Color Handle)
膠柄鐵燒腊刀

CODE	SIZE (l x w cm)	Type
5060201-BL	25.0 x 13.5	1
5060202-BL	24.5 x 13.0	2



Iron Siew Lap Knife
(Wooden Handle)
木柄鐵燒腊刀

CODE	SIZE (l x w cm)	Type
5060101	25.0 x 13.5	1
5060102	24.5 x 13.0	2
5060103	24.0 x 12.5	3



Mun Mo Chu Knife (Wooden Handle)
木柄鐵文武厨刀

CODE	SIZE (l x w cm)	Type
5062701	24.0 x 12.5	1
5062702	22.5 x 12.0	2
5062703	21.5 x 11.0	3



Iron Mun Mo Chu Knife (Colour Handle)
膠柄鐵文武厨刀

CODE	SIZE (l x w cm)	Type
5062801-xx	24.0 x 12.5	1
5062802-xx	22.5 x 12.0	2
5062803-xx	21.5 x 11.0	3



Stainless Steel Mun Mo Chu Knife
(Wooden Handle)
木柄鋼文武厨刀

CODE	SIZE (l x w cm)	Type
5062901	24.0 x 12.5	1
5062902	22.5 x 12.0	2
5062903	21.5 x 11.0	3

***Available Colour**

■ RD □ WH ■ BL

When ordering Red Handle add **CODE** suffix to item number (example: 5062801-RD)



Stainless Steel Mun Mo Chu Knife
(Colour Handle)
胶柄钢文武厨刀

CODE	SIZE (l x w cm)	Type
5063001-xx	24.0 x 12.5	1
5063002-xx	22.5 x 12.0	2
5063003-xx	21.5 x 11.0	3

***Available Color**

RD WH BL YE

When ordering Red Handle add **CODE** suffix to item number (example: 5063001-RD)



Stainless Steel Kow Kong Knife
(Colour Handle)
胶柄钢九江刀

CODE	SIZE (l x w cm)	Type
5062101-xx	19 x 12	1
5062102-xx	18 x 11	2
5062103-xx	17 x 10	3

***Available Color**

RD WH GR BL YE BR

When ordering Red Handle add **CODE** suffix to item number (example: 5062101-RD)

Fish Head Knife
铁鱼刀

CODE	SIZE (l x w cm)	
5063101	18 x 13	Iron
5063202	18 x 13	Stainless Steel





Rect Wooden Chopping Board
长方斩板

CODE	SIZE	
	(w x l cm)	inch
3080205	12.7 x 20.3	5 x 8
3080206	15.0 x 25.4	6 x 10
3080207	17.7 x 27.9	7 x 11
3080208	20.3 x 30.4	8 x 12
3080209	22.8 x 33.0	9 x 13
3080210	25.4 x 35.5	10 x 14
3080211	25.4 x 60.9	10 x 24
3080212	30.4 x 43.0	12 x 17



Stainless Steel Chopping Board Stand
不锈钢斩板架

CODE	SIZE	
	(l cm)	inch
3080316	40.6	16.0
3080318	45.7	18.0
3080319	49.5	19.5
3080320	50.8	20.0



***Available Colour**

■ RD □ WH ■ GR ■ BL ■ YE ■ BR

When ordering Red add **CODE** suffix to item number
(example: 3080404-RD)



Round Wooden Chopping Board
圆木斩板

CODE	SIZE	
	(ø cm)	inch
3080107	17.7	7
3080108	20.3	8
3080109	22.8	9
3080110	25.4	10
3080111	27.9	11
3080112	30.4	12
3080113	33.0	13
3080114	35.5	14
3080115	38.0	15
3080116	40.6	16
3080117	43.0	17
3080118	45.7	18
3080120	50.8	20
3080121	53.3	21
3080122	55.8	22
3080123	58.4	23
3080124	60.9	24



Wooden Chopping Board Stand
木斩板架

CODE	SIZE	
	Type	inch
5080116	fit for : 40.6	16
5080118	fit for : 45.7	18
5080119	fit for : 48.0	19
5080120	fit for : 50.8	20
5080122	fit for : 55.8	22
5080123	fit for : 58.4	23

Round Plastic Cutting Board
圆形胶斩板

CODE	SIZE	
	(Ø x h cm)	(Ø x h inch)
3080405	40 x 5.0	16 x 2.0
3080438	38 x 5.0	15 x 2.0
3080435	35 x 5.0	14 x 2.0
3080433	33 x 5.0	13 x 2.0
3080428	28 x 5.0	11 x 2.0
3080425	25 x 5.0	10 x 2.0
3080410-xx	40 x 10.0	16 x 4.0
3080506-xx	45 x 6.0	18 x 2.5
3080510-xx	45 x 10.0	18 x 4.0
3080515-xx	45 x 15.0	18 x 6.0
3080614-xx	48 x 13.5	19 x 5.3



High Density Polyethylene Cutting Board
ColorCode cutting boards are the ultimate defense in the prevention of cross-contamination. Exceptionally durable and essential for safe food preparation. The high-density polyethylene is dishwasher safe. Made in the U.S.A.

High Density Color Coded Poly Cutting Board 长方形胶斩板

CODE	SIZE		THICKNESS
	(l x w x h cm)	(l x w x h inch)	
3080730-xx	30.4 x 45.7 x 1.27	12 x 18 x 0.5	1/2
3080838-xx	38.0 x 50.8 x 1.27	15 x 20 x 0.5	1/2
3080945-xx	45.7 x 60.9 x 1.27	18 x 24 x 0.5	1/2
3081030-xx	30.4 x 45.7 x 1.90	12 x 18 x 0.75	3/4
3081138-xx	38.0 x 50.8 x 1.90	15 x 20 x 0.75	3/4
3081245-xx	45.7 x 60.9 x 1.27	18 x 24 x 0.75	3/4

***Available Color**

BL GR TN WH RD YE

When ordering Blue Board add **CODE** suffix to item number (example: 3080730-BL)



Medium Density Color Coded Plastic Cutting Board 长方形胶斩板

CODE	SIZE		THICKNESS
	(l x w x h cm)	(l x w x h inch)	
3081230-xx	30.4 x 45.7 x 1.27	12 x 18 x 0.5	1/2
3081338-xx	38.0 x 50.8 x 1.27	15 x 20 x 0.5	1/2
3081445-xx	45.7 x 60.9 x 1.27	18 x 24 x 0.5	1/2
3081530-xx	30.4 x 45.7 x 1.90	12 x 18 x 0.7	3/4
3081638-xx	38.0 x 50.8 x 1.90	15 x 20 x 0.7	3/4
3081745-xx	45.7 x 60.9 x 1.90	18 x 24 x 0.7	3/4

***Available Colour**

BL GR BR WH RD

When ordering Blue Board add **CODE** suffix to item number (example: 3080730-BL)



Rectangular Plastic Cutting Board 长方形胶斩板

CODE	SIZE		THICKNESS
	(l x w x h cm)	(l x w x h inch)	
3081801	30.50 x 45.80 x 2.5	12 x 18 x 1	1
3081802	30.50 x 45.80 x 5.0	12 x 18 x 2	2
3081803	30.50 x 60.90 x 2.5	12 x 24 x 1	1
3081804	38.00 x 50.80 x 2.5	15 x 20 x 1	1
3081805	38.00 x 50.80 x 5.0	15 x 20 x 2	2
3081806	40.60 x 121.9 x 2.5	16 x 48 x 1	1
3081807	40.60 x 121.9 x 5.0	16 x 48 x 2	2
3081808	45.80 x 60.90 x 2.5	18 x 24 x 1	1
3081809	45.80 x 60.90 x 5.0	18 x 24 x 2	2
3081810	45.80 x 76.00 x 2.5	18 x 30 x 1	1
3081811	45.80 x 76.00 x 5.0	18 x 30 x 2	2
3081812	45.80 x 91.40 x 2.5	18 x 36 x 1	1
3081813	45.80 x 91.40 x 5.0	18 x 36 x 2	2
3081814	45.80 x 121.9 x 2.5	18 x 48 x 1	1
3081815	45.80 x 121.9 x 5.0	18 x 48 x 2	2
3081816	60.90 x 121.9 x 2.5	24 x 48 x 1	1
3081817	60.90 x 121.9 x 5.0	24 x 48 x 2	2
3081818	101.6 x 243.8 x 2.5	40 x 96 x 1	1



Economy Rectangular Cutting Board
胶斩板

CODE	SIZE	
	(l x w x h cm)	(l x w x h inch)
3081924	24.0 x 15.0 x 0.9	9.4 x 5.9 x 0.3
3081929	30.0 x 21.8 x 1.0	11.6 x 8.2 x 0.3
3081935	35.4 x 25.2 x 1.2	13.9 x 9.7 x 0.3
3081943	44.0 x 29.0 x 1.2	17.0 x 11.2 x 0.5
3081949	50.5 x 34.0 x 1.4	19.4 x 12.9 x 0.5



2-Sided "LARGE" Red Indian Carbon Sharpening Stone
两面磨刀石

CODE	SIZE
	(l x w x h cm)
3040500	20.3 x 7.6 x 5



Double Sided Sharpening Stone
两面磨刀石

CODE	SIZE	
	(l x w x h cm)	
3040615	15.0 x 5 x 2.5	Small
3040620	20.3 x 5 x 2.5	Medium



"ORIGINAL" Red Indian Carbonum Sharpening Stone
原装三番头磨刀石

CODE	SIZE
	(l x w x h cm)
3040700	20.3 x 7.6 x 5



Green Sharpening Stone
青色磨刀石

CODE	SIZE	REMARKS
	(l x w x h cm)	roughness
3041000	20.3 x 5 x 5	200



Yellow Sharpening Stone
磨刀石

CODE	SIZE	REMARKS
	(l x w x h cm)	roughness
3041100	20.3 x 7.6 x 2.5	4000



Orange Sharpening Stone, Fuji #1000
磨刀石

CODE	SIZE	REMARKS
	(l x w x h cm)	roughness
3041200	20.3 x 7.6 x 5	1000



Sharpening Stone Holder
磨刀石

CODE	SIZE
	(l x w x h cm)
3040900	5.5" x 8.5" x 7.6 x 5



Fish Scaler (Plastic Handle)
胶柄短头鱼鳞刮

CODE	SIZE (l cm)	
3130219	19.0	Short
3130224	24.7	Long



Fish Scaler (Nylon Handle)
鱼鳞刨刀



CODE	SIZE (l cm)
3130823	23.5



Stainless Steel 1-Pc Fish Scaler
不锈钢鱼鳞刮

CODE	SIZE (l cm)
3130322	22.8



Copper Fish Scaler (Wooden Handle)
木柄鱼鳞刮

CODE	SIZE (l cm)
3130416	16
3130418	18



Beige Plastic Crescent Shape Container
弯月形胶斩板兜

CODE	SIZE
5080401	1
5080402	2



Stainless Steel Chopping Board Shield Guard
钢斩板围

CODE	SIZE (Inch)
5080214	14



Stainless Steel Crescent Shape Container
弯月形钢斩板兜

CODE	SIZE
5080301	1
5080302	2



Stainless Steel Rect Knife Rack
钢刀箱

CODE	SIZE (l x w x h cm)	
5080503	26 x 14.0 x 14.0	3 Comp
5080504	26 x 18.0 x 14.0	4 Comp
5080603	26 x 14.5 x 14.5	3 Comp with Cover



Stainless Steel 'Y' Shape Hook
不锈钢“Y”形钩

CODE	SIZE (l cm)
5090215	15



Stainless Steel 'Y' Shape Hook
不锈钢“Y”形钩 陳枝記

CODE	SIZE (l cm)
5090115	15



Stainless Steel X-Thick 2-Prong Pig Hanger
不锈钢加厚猪叉

CODE	SIZE (l cm)	inch
5090424	60.9	24



Stainless Steel 'J' Shape Hook
不锈钢“J”形钩

CODE	SIZE (l cm)	inch
5090306	16.5	6



Stainless Steel Pigeon 3-Prong Hanger
不锈钢乳鸽环

CODE	SIZE (l cm)
5090500	



Stainless Steel 'PE-PAI' Duck Hanger
不锈钢琵琶鸭叉

CODE	SIZE (l cm)	inch
5090418	45.7	18



Stainless Steel X-Thick Pork Hanger
加厚不锈钢烧肉钩

CODE	SIZE (l cm)	inch	TYPE Hook
5090703	16.5	6	3



Stainless Steel 2-Hook Hanger
不锈钢2钩式

CODE	SIZE (l cm)	inch	TYPE
5090604	10	4	Short
5090606	15	6	Medium
5090609	22.8	9	Duck



Stainless Steel Char Siew Hanger
不锈钢 钢衣架形叉烧钩

CODE	SIZE	
	(l cm)	inch
5090816	40.6	16
5090818	45.7	18
5090820	50.8	20



Stainless Steel 'S' Shape Hook
不锈钢 "S" 形钩

CODE	SIZE	
	(l cm)	inch
5090904	10.0	4
5090905	12.7	5
5090906	15.0	6
5090907	17.7	7
5090908	20.3	8
5090909	22.8	9
5090910	25.4	10
5090912	30.4	12



Stainless Steel 'S' Shape Chicken Hook
不锈钢 "S" 形挂鸡钩

CODE	SIZE	
	(l cm)	inch
5091006	15.0	6
5091007	17.7	7
5091008	20.3	8



Stainless Steel X-Thick Long Hook
加厚不锈钢长钩

CODE	SIZE	
	(l cm)	inch
5091136	99	36



Stainless Steel Hand Hook
木柄不锈钢手钩

CODE	SIZE	
	(l cm)	inch
5091216	40.6	16
5091220	50.8	20



Stainless Steel 3-Prong Suckling Pig Skewer
木柄不锈钢烧猪叉 (3叉)

CODE	SIZE	
	(l cm)	inch
5091422	55.8	22
5091424	60.9	24
5091426	66.0	26



Stainless Steel 2-Prong Suckling Pig Skewer
木柄不锈钢烧猪叉(2叉)

CODE	SIZE	
	(l cm)	inch
5091322	50.0	22
5091324	60.9	24
5091326	66.0	26



Aluminium Steam / BBQ Pig Rod
铝烧猪棍

CODE	SIZE	
	(l cm)	inch
5091515	15.0	6
5091543	43.2	17

CHINESE KITCHEN



Roast Pork Picker
木柄肉插

CODE	SIZE (l cm)	inch	TYPE
5092200	15	6	Square
5092100	18	7	Round



Stainless Steel BBQ Chicken Wing Skewer with Front Lock
不锈钢烤鸡翅膀叉 (有锁)

CODE	SIZE (l cm)	inch
5091600	50	20



Stainless Steel Golden Coin Chicken Needle / Skewer
不锈钢鸡针

CODE	SIZE (l cm)
5092040	40.6



Stainless Steel Duck Needle
不锈钢鸭尾针

CODE	SIZE (l cm)
5091915	15



Stainless Steel BBQ Skewer
环形头不锈钢叉烧针

CODE	SIZE (l cm)	inch
5091808	20.3	8
5091809	22.8	9
5091810	25.4	10
5091812	30.4	12
5091814	35.5	14
5091815	38.0	15
5091816	40.6	16
5091818	45.7	18
5091820	50.8	20
5091824	60.0	24



Stainless Steel BBQ Skewer
不锈钢叉烧针

CODE	SIZE (l cm)	inch
5091709	22.8	9
5091710	25.4	10
5091712	30.4	12
5091713	33.0	13
5091714	35.5	14
5091715	38.0	15
5091716	40.6	16
5091718	45.7	18
5091720	50.8	20



Apollo Roast Duck Oven
不锈钢碳烧鸭炉

CODE	SIZE (l cm)	inch	TYPE
5092328	71.0	28	8 Ducks
5092332	81.0	32	10 Ducks
5092336	91.4	36	12 Ducks



Charcoal Roast Sucking Pig Stove
烧猪炉

CODE	SIZE (l cm)	(inch)
5092436	91.4	36
5092441	104	41



Apollo Charcoal Stove with Base
炉胆 (有底)

CODE	SIZE (ø cm)	inch
5092625	25.4	10.0
5092627	26.6	10.5
5092630	30.4	12.0



Iron Metal Charcoal Tong
铁火炭夹

CODE	SIZE (l cm)
5092801	40
5092802	50
5092803	60



Apollo Charcoal Stove without Base
炉胆 (无底)

CODE	SIZE (ø cm)	inch
5092725	25.4	10.0
5092727	26.6	10.5



Stool For Chinese BBQ
铁桌

CODE	SIZE (l x w x h cm)
5092900	45.7 x 30.4 x 25.4



5093013



5093023

Electric Table Top Bain Marie
电汁箱



5093011

CODE	TYPE	VOLTAGE / WATT
5093011	1 / 3 x 3 (1/1)	230V / 2500W
5093012	1 / 6 x 3 (1/2)	230V / 1500W
5093013	1 / 3 x 1 (1/3)	230V / 1000W
5093023	1 / 3 x 2 (2/3)	230V / 2000W



Stainless Steel Rectangular Maltose Box
 不锈钢长方形麦芽糖箱

CODE	SIZE	
	(l cm)	inch
5093118	45.7	18
5093120	50.8	20
5093122	55.8	22



Stainless Steel Maltose Box with Wheel Rack (Set)
 不锈钢长方形麦芽糖箱(全套)

CODE	SIZE	
	(l cm)	Inch
5093400	45.7	18

Stainless Steel Maltose Box Rack Only
 不锈钢长方形麦芽糖架

CODE	SIZE	
	(l cm)	inch
5093218	45.7	18
5093220	50.8	20
5093222	55.8	22



Stainless Steel Roasted Meat Rack Trolley
 不锈钢吊叉烧架

CODE	SIZE
	(l x w x h cm)
5093500	150 x 150 x 158



2 Layer Stainless Steel Roasted Meat Rack
 不锈钢双层吊叉烧架

CODE	SIZE
	(l x w x h cm)
5093700	76 x 42 x 180



Bamboo Steamer (Bamboo Rim)
平底全竹蒸笼

CODE	SIZE (Ø cm)	Ø inch
5100105	12.0	5.0
5100106	15.0	6.0
5100165	16.5	6.5
5100108	20.3	8.0
5100110	25.4	10
5100112	30.4	12
5100114	35.5	14



Mini Bamboo Steamer (Bamboo Rim)
迷你竹蒸笼

CODE	SIZE (Ø cm)	Ø inch
5102509	9	3.5
Cover		
5102609	9	3.5



Bamboo Steamer (Stainless Steel Rim)
平底钢边竹蒸笼

CODE	SIZE (Ø cm)	Ø inch
5100305	12.7	5.0
5100306	15.0	6.0
5100365	16.5	6.5



Bamboo Steamer (Aluminium Reinforce Rim)
平底铝边竹蒸笼

CODE	SIZE (Ø cm)	Ø inch
5100205	12.7	5.0
5100206	15.0	6.0
5100265	16.5	6.5



**High Base Bamboo Steamer
(Bamboo Rim)**
高底全竹蒸笼

CODE	SIZE (Ø cm)	Ø inch
5100505	12.7	5.0
5100506	15.0	6.0
5100565	16.5	6.5



Bamboo Steamer Cover
竹蒸笼盖

CODE	SIZE (Ø cm)	Ø inch
5100405	12.7	5.0
5100406	15.0	6.0
5100465	16.5	6.5
5100408	20.3	8.0
5100410	25.4	10
5100412	30.4	12
5100414	35.5	14



High Base Bamboo Steamer
(Aluminium Rim)
高身铝边竹蒸笼

CODE	SIZE	
	(Ø cm)	Ø inch
5100605	12.7	5"
5100606	15.0	6"
5100665	16.5	6.5"



High Base Bamboo Steamer
(Stainless Steel Rim)
高身钢边竹蒸笼

CODE	SIZE	
	(Ø cm)	Ø inch
5100705	12.7	5"
5100706	15.0	6"
5100765	16.5	6.5"



High Base Bamboo Cover
高身竹蒸笼盖

CODE	SIZE	
	(Ø cm)	Ø inch
5100805	12.7	5"
5100806	15.0	6"
5100865	16.5	6.5"



Deluxe Bamboo Steamer
毛竹蒸笼

CODE	SIZE	
	(Ø cm)	Ø inch
5100905	12.7	5"
5100906	15.0	6"
5100907	16.5	6.5"
5100908	20.3	8"
5100910	25.4	10"
5100912	30.4	12"
5100914	35.5	14"



Deluxe Bamboo Cover
毛竹蒸笼盖

CODE	SIZE	
	(Ø cm)	Ø inch
5101005	12.7	5"
5101006	15.0	6"
5101007	16.5	6.5"
5101008	20.3	8"
5101010	25.4	10"
5101012	30.4	12"
5101014	35.5	14"



Bamboo Steamer
全竹蒸笼

CODE	SIZE	
	(Ø cm)	Ø inch
5101121	53.3	21"



Bamboo Steamer Cover
竹蒸笼盖

CODE	SIZE	
	(Ø cm)	Ø inch
5101221	53.3	21



Square Deluxe Hokkien Wooden Steamer (Square Edge)
方形方角柳杉木蒸笼

CODE	SIZE	
	(l x w x h cm)	
5101333	33 x 33	

Cover

5101433 33 x 33

*size can be customized upon request.
Please approach us for more instructions.



Round Deluxe Wooden Steamer
圆形柳杉木蒸笼, 铜线

CODE	SIZE	
	(ø cm)	Inch
5101616	40	16

Cover

5101816 40 16

*size can be customized upon request.
Please approach us for more instructions.



Rectangular Wooden Steamer
长形方角柳杉木蒸笼, 包钢边

CODE	SIZE	FITS
	(l x w cm)	
5101511	32.5 x 53	1/1 Size
5101523	35.0 x 33	2/3 Size
5101512	28.0 x 34	
5101500	16.0 x 22	1/2 Size

Cover

5101711 32.5 x 53

5101723 35.0 x 33

5101712 28.0 x 34

5101700 16.0 x 22

*size can be customized upon request.
Please approach us for more instructions.

Square Deluxe Mini Wooden Steamer (Round Edge)
方形圆角柳杉木蒸笼

CODE	SIZE	
	(Ø cm)	Ø inch
5103110	10	4

Cover

5103210 10 4



CHINESE KITCHEN



Deluxe Hokkien Bamboo Steamer
迷你毛竹蒸笼

CODE	SIZE	
	(Ø cm)	Ø inch
5102710	10	4
Cover		
5102810	10	4



Square Deluxe Hokkien Wooden Steamer (Round Edge)
方形圆角柳杉木蒸笼

CODE	SIZE	
	(l cm)	inch
5102113	13	5
5102115	15	6
5102118	18	7
5102121	21	8
5102126	26	10
5102130	30	12
Cover		
5102213	13	5
5102215	15	6
5102218	18	7
5102221	21	8
5102226	26	10
5102230	30	12



Triangle Deluxe Hokkien Wooden Steamer (Round Edge)
三角形圆角柳杉木蒸笼

CODE	SIZE	
	(l cm)	inch
5101915	15	6
5101918	18	7
5101921	21	8
Cover		
5102015	15	6
5102018	18	7
5102021	21	8



Oval Deluxe Hokkien Wooden Steamer (Round Edge)
椭圆形柳杉木蒸笼

CODE	SIZE	
	(l cm)	inch
5102315	15	6
5102318	18	7
5102321	21	8
5102323	23	9
Cover		
5102415	15	6
5102418	18	7
5102421	21	8
5102423	23	9



Stainless Steel 8-Tier Triangle Shape Rack
不锈钢三角架 (八层)

CODE	SIZE (w x h cm)
5110108	56 x 175
5110208	Teochew Style



Copper Pastry Wheel
铜花车轮

CODE	SIZE (l cm)
5110413	13.5



Multiple Dough Cutter (with Marking)
多轮单用轮刀

CODE	SPEC
5110608	5 Wheels
5110607	7 Wheels



Stainless Steel Single Tier Triangle Shape Rack
不锈钢三角架 (单层)

CODE	SIZE (Ø x h cm)
5110101	56 x 30



Bamboo Tim Sum Spatula
包陷料竹片

CODE	SIZE (l cm)
5110324	24



Stainless Steel Pastry Edge Clip
不锈钢花边夹

CODE	SIZE (l cm)
5110507	7



Stainless Steel Vegetable Carving Tools Set (6 Pcs)
6支钢雕刻工具

CODE
6210901



Stainless Steel Round Ingredient Plate with Stand
不锈钢馅料盘

CODE	SIZE	
	(ø cm)	inch
5110709	22.8	9
5110710	25.4	10
5110711	27.5	11
5110712	30.4	12
5110714	35.5	14



Bean Curd Scoop (Wooden Handle)
木柄不锈钢豆花铲

CODE	SIZE
	(l cm)
5110800	12



Metal Scissor Tong
剪刀形点心夹

CODE	SIZE
	(l cm)
5110925	25



Traditional Tim Sum Scale
不锈钢钢点心秤

CODE	SIZE
	(l cm)
5111001	



Tim Sum Paper (500'S)
蒸笼纸 (500张)

CODE	SIZE	
	(ø cm)	inch
5111104	10.0	4.0
5111145	11.4	4.5
5111155	13.9	5.0
5111165	16.5	6.0
5111108	20.3	8.0
5111110	25.4	10.0
5111111	27.9	11.0
5111115	39.0	15.5



Oval Tim Sum Paper (500'S)
椭圆形蒸笼纸 (500张)

CODE	SIZE	
	(ø cm)	inch
5111213	13.0	5
5111215	15.5	6
5111218	18.0	7



Rectangular Dim Sum Paper
长形蒸笼纸

CODE	SIZE	
	(l cm)	
5114101	49.5 x 28.5	500 Pcs / Pkt



Square Tim Sum Paper (500'S)
方形蒸笼纸 (500张)

CODE	SIZE	
	(l cm)	inch
5111313	13	5
5111315	15	6
5111318	18	7



Steam Pao Paper
点心包纸

CODE	SIZE (l cm)	
5113906	6 x 6	10-Bundle / Box
5113907	7 x 7	8-Bundle / Box



Thicker Boneless Chicken Bag
纸包鸡袋

CODE	REMARKS
5114201	200 pcs



Cloth-Style Stainless Steel Chang Fun Cooker Pot with Cover
不锈钢肠粉炉

CODE	SIZE (l x w x h cm)
5111500	58 x 55 x 16



Drawer-Style Stainless Steel Chang Fun Cooker Pot with Cover
钢肠粉炉

CODE	SIZE (l x w x h cm)	
5111405	55 x 55 x 37	5 Drawer
5111404	55 x 55 x 34	4 Drawer



Stainless Steel Steam Plate
密洞钢蒸笼片

CODE	SIZE (Ø cm)	inch
5111604	10.0	4.0
5111645	11.4	4.5
5111605	12.7	5.0
5111606	15.0	6.0
5111607	18.0	7.0
5111608	20.3	8.0
5111610	25.4	10
5111612	30.4	12
5111613	33.0	13
5111614	35.5	14
5111615	38.0	15
5111616	40.6	16
5111617	43.2	17
5111618	45.7	18
5111619	48.3	19
5111620	50.8	20
5111621	53.3	22



Stainless Steel Steam Plate
不锈钢笼片

CODE	SIZE (Ø cm)	TYPE Holes
5111701	60.9	1
5111703	60.9	3
5111707	60.9	7



Stainless Steel Tapered Oil Funnel
不锈钢锥形油斗

CODE	SIZE (l cm)
5111900	13 x 20



Stainless Steel Tapered Oil Funnel Stand
不锈钢锥形油斗架

CODE	SIZE (l cm)
5112000	11.5 x 13 x 16.5



Stainless Steel Flour Mixture Dispenser
不锈钢面粉漏斗

CODE	SIZE
5112100	14.5 x 29



Stainless Steel Flour Mixture Dispenser Stand
不锈钢面粉漏斗架

CODE	SIZE (l cm)
5112200	15 x 23



Stainless Steel Round Flour Sieve
不锈钢面粉筛

CODE	SIZE (ø cm)	inch
5112320	20	8
5112324	24	9
5112327	27	11
5112330	30	12
5112333	33	13
5112336	36	14
5112339	39	16
5112342	42	17





Stainless Steel Egg Strainer
双耳钢蛋水隔

CODE	SIZE	
	(l cm)	inch
5112520	20	8
5112523	23	9
5112525	25	10
5112530	30	12
5112535	35	14
5112538	38	15



Stainless Steel Fine Mesh Egg Strainer
双耳不锈钢蛋水隔

CODE	SIZE	
	(l cm)	inch
5112409	23	9
5112410	25	10
5112412	30	12
5112414	35	14
5112415	38	15



Stainless Steel Conical Colander
钢菜蓝

CODE	SIZE
	(l cm)
5112925	25.5
5112928	28.5
5112931	31.5



GOURMET
STEEL

Stainless Steel Gyoza Container
钢饺子盒

CODE	SIZE	TYPE
	(l x w x h cm)	
5112601	40.0 x 30 x 4	Large
5112602	33.5 x 26 x 4	Small
Cover		
5112701	41.0 x 31 x 1.4	
5112702	34.5 x 27 x 1.4	



Stainless Steel Rectangular Container
有盖长方形不锈钢盒

CODE	SIZE
	(l x w x h inch)
5113003	6.50 x 10 x 3.0
5113004	7.50 x 12 x 3.0
5113005	10.0 x 13 x 3.5



Stainless Steel Square Container
有盖方形不锈钢盒

CODE	SIZE
	(l x w x h inch)
5113101	12 x 12 x 2.5

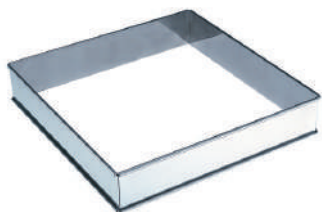

Stainless Steel Square Ring
方形不锈钢圈

CODE	SIZE (l x w x h inch)
5113201	12 x 12 x 2.5

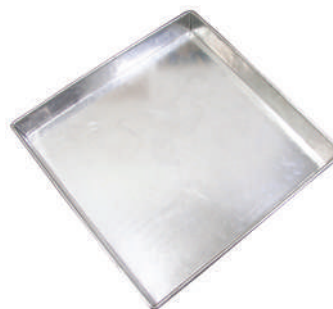

Square Baking Pan
方形烤盘

CODE	SIZE (l x w x h inch)	
5113301	19 x 19 x 1.5	Aluminium
5113302	19 x 19 x 2.0	Aluminium
5113303	20 x 20 x 1.5	Aluminium
5113401	19 x 19 x 2.0	Iron
5113402	20 x 20 x 2.0	Iron



Round Baking Pan
铝圆形烤盘

CODE	SIZE		Type
	(ø cm)	inch	
5113518	45.7	18	Aluminium
5113519	48.3	19	Aluminium
5113618	45.7	18	Iron



Stainless Steel Yam Cake Fryer
芋头炸篮

CODE	SIZE (ø cm)
5114012	12
5114014	14
5114016	16
5114018	18



Aluminium Round Egg Tart Mould

CODE	SIZE (w x h cm)	TYPE
5113701	7.5 x 2.5	No. 1
5113703	7.0 x 2.2	No. 3
5113704	6.8 x 2.5	No. 4
5113710	8.5 x 2.5	No. 10
5113716	6.9 x 2.0	No. 16
5113718	5.5 x 2.0	No. 18
5113720	5.0 x 2.0	No. 20



Aluminium Oval Egg Tart Mould

CODE	SIZE (w x h cm)	TYPE
5113801	8.5 x 6.0 x 1.6	No. 1
5113802	8.0 x 6.0 x 1.6	No. 2
5113803	6.0 x 4.5 x 1.7	No. 3
5113804	5.0 x 3.5 x 1.5	No. 4



Aluminium Baking Tray (Angled Edge)
长方形铝托盘

CODE	SIZE (l x w x h cm)	THICKNESS	
2020500	60 x 40 x 2	1.5 mm	Non-Stick
2020600	60 x 40 x 2	1.5 mm	Standard





Round Cutter
14头圆形光面钢切模

CODE	QTY (pcs)	TYPE
5120115	14	Plain
6202908	8	Fluted
6203009	9	Fluted
6203014	14	Fluted

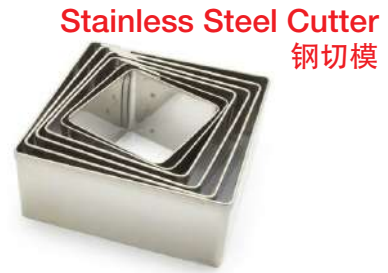

Stainless Steel Cutter
钢切模

6 Pcs 'Square' Cutter
6头四方形钢切模

CODE	SIZE (l cm)
5120110	



9 Pcs 'Oval' Cutter
9头椭圆形钢切模

CODE	SPEC
6203209	Plain
6203309	Fluted



6 Pcs Triangle Cutter
6头三角形钢切模

CODE	SIZE (l cm)
5120112	



6 Pcs Hexagon Cutter
6头六角形' 钢切模

CODE	SIZE (l cm)
5120108	



6 Pcs Hexagram Star Cutter
六角星形钢切模

CODE	SIZE (l cm)
5120101	



5 Pcs Star Cutter
5角星形钢切模

CODE	SIZE (l cm)
6203706	



Heart Shape Cutter
心形钢切模

CODE	QTY (pcs)	TYPE
6203806	6	Plain
6203908	8	Fluted

Stainless Steel Cutter 钢切模



6 Pcs Blossom Shape Cutter 6头梅花钢切模

CODE	SIZE (l cm)
5120106	



6 Pcs Semi Circle Shape Cutter 6头半圆形钢切模

CODE	SIZE (l cm)
5120109	



6 Pcs Tear Drop Shape Cutter 6头水滴型钢切模

CODE	SIZE (l cm)
5120111	



6 Pcs Assorted Shape Cookies Cutter 6头饼干钢切模

CODE	SIZE (l cm)
5120107	



Numeric 数字

CODE	TYPE (pcs)
5120113	10 / Set



Alphabet 英文字母

CODE	TYPE (pcs)
5120114	26 / Set



Pineapple (Thick Aluminium) 厚铝凤梨

CODE	SIZE (cm)
5120200	9.5



Heart (Thick Aluminium) 厚铝心形

CODE	SIZE (cm)
5120201	9.5



Fish (Thick Aluminium) 厚铝鱼形

CODE	SIZE (cm)
5120203	30

Stainless Steel Cutter 钢切模



Prawn
虾

CODE	SIZE (l x w cm)
5120301	7 x 3



Lobster
龙虾

CODE	SIZE (l x w cm)
5120324	4.5 x 2



Crab
蟹

CODE	SIZE (l x w cm)	
5120302	5.5 x 4.0	Large
5120319	4.0 x 3.0	Small



Dragon
龙

CODE	SIZE (l x w cm)
5120306	11 x 5



Peony Flower
牡丹花

CODE	SIZE (l x w cm)	
5120304	4.5 x 3	Large
5120305	3.5 x 2.5	Small



Squirrel
松鼠

CODE	SIZE (l x w cm)
5120303	3 x 3



Dragon
龙

CODE	SIZE (l x w cm)
5120314	7.5 x 3.5



Single Coin
钱币

CODE	SIZE (l x w cm)
5120329	2.5

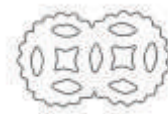

Double Coin
双钱

CODE	SIZE (l x w cm)
5120307	4 x 2.5



Sakura Flower
樱花

CODE	SIZE (l x w cm)	
5120310	3.5 x 3.5	Large
5120311	2.5 x 2.5	Small



Peach
桃

CODE	SIZE (l x w cm)
5120330	4.5 x 3.5



Peach
桃

CODE	SIZE (l x w cm)
5120308	8 x 5.5



Maple Leaf
枫叶

CODE	SIZE (l x w cm)
5120331	3.5 x 3



Maple Leaf
枫叶

CODE	SIZE (l x w cm)
5120309	4 x 3



Chrysanthemum
菊花

CODE	SIZE (l x w cm)
5120335	3.5 x 2.5

CHINESE KITCHEN

Stainless Steel Cutter 钢切模



Orchid
兰花

CODE	SIZE (l x w cm)
5120332	4 x 4



Tulip Flower
郁金香花

CODE	SIZE (l x w cm)
5120336	4 x 4



Round Flower
花

CODE	SIZE (l x w cm)
5120325	2.5 x 2



Butterfly
蝴蝶

CODE	SIZE (l x w cm)	
5120312	5.0 x 3.0	Large
5120313	3.5 x 2.5	Small



Butterfly
蝴蝶

CODE	SIZE (l x w cm)
5120316	4 x 3



Windmill
风车

CODE	SIZE (l x w cm)
5120326	2.5



Gold Fish
金鱼

CODE	SIZE (l x w cm)
5120318	4 x 2



Gold Fish
金鱼

CODE	SIZE (l x w cm)
5120317	4 x 2.5



Dolphin
海豚

CODE	SIZE (l x w cm)
5120328	5 x 2.5



Phoenix
凤凰

CODE	SIZE (l x w cm)
5120315	11 x 6.5



Phoenix
凤凰

CODE	SIZE (l x w cm)
5120333	5 x 3



Orchid
兰花

CODE	SIZE (l x w cm)
5120334	3.5 x 3.5



Standing Rabbit
兔

CODE	SIZE (l x w cm)
5120321	3.5 x 2.5



Running Rabbit
兔

CODE	SIZE (l x w cm)
5120322	3.5 x 3



Teddy Bear
熊

CODE	SIZE (l x w cm)
5120327	4.5 x 3

Stainless Steel Cutter 钢切模



Duck
鸭

CODE	SIZE (l x w cm)
5120339	4 x 3



Deer
鹿

CODE	SIZE (l x w cm)
5120320	5 x 4.5

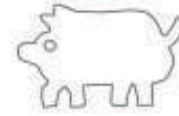

Pig
猪

CODE	SIZE (l x w cm)
5120323	4 x 2.5



Lovely Bird
鸳鸯

CODE	SIZE (l x w cm)
5120338	3 x 3



Angel Fish
天使鱼

CODE	SIZE (l x w cm)
5120340	3.5 x 3.5



Mudcarp Fish
鱼

CODE	SIZE (l x w cm)
5120337	7 x 3



Oval Paper Lace Doyley
椭圆形花纸 (250 Pcs / Pkt)

CODE	SIZE (l x w Inch)
5190201	6.5 x 9.0
5190202	7.0 x 10.0
5190203	7.5 x 10.5
5190204	8.0 x 12.0
5190205	8.5 x 12.5
5190206	10.5 x 14.0



Rectangular Paper Lace Doyley
方形花纸 (250 Pcs / Pkt)

CODE	SIZE (l x w Inch)
5190301	5.5 x 9.5
5190302	7.0 x 12.0
5190303	10.0 x 14.5
5190304	12.0 x 16.0
5190305	12.5 x 18.5
5190306	14.0 x 18.0



Paper Cake Cup
蛋挞纸 (1000 Pcs / Pkt)

CODE	SIZE (Ø x h cm)
5190401	5.5 x 2.2
5190402	6.0 x 2.5
5190403	7.0 x 3.1
5190404	7.5 x 3.3
5190405	9.5 x 4.3



Round Paper Lace Doyley
圆形花纸 (250 Pcs / Pkt)

CODE	SIZE (Ø Inch)	CODE	SIZE (Ø Inch)
5190101	4.0	5190111	9.0
5190102	4.5	5190112	9.5
5190103	5.0	5190113	10.0
5190104	5.5	5190114	10.5
5190105	6.0	5190115	12.0
5190106	6.5	5190116	12.5
5190107	7.0	5190117	13.5
5190108	7.5	5190118	14.5
5190109	8.0	5190119	15.5
5190110	8.5	5190120	16.5



Wooden Rolling Pin
木擀面棍

CODE	SIZE (l cm)	TYPE
5130130	30	Slim
5130230	30	Thick



Plastic Rolling Pin
粗胶擀面棍

CODE	SIZE (l cm)
5130428	28
5130440	40



Wooden Rolling Pin "MA ZAI"
“马仔”木擀面棍

CODE	SIZE (l cm)
5130775	75 x 5



Long Slim Wooden Rolling Pin
长细木擀面棍

CODE	SIZE (l cm)
5130640	40



Beechwood Rolling Pin
木擀面棍



CODE	SIZE (l cm)
6050501	50 x 5



Non-Stick Nylon Rolling Pin
尼龙擀面棍



CODE	SIZE (l cm)
5132001	50 x 4.5



Wooden Rolling Pin (Stainless Steel Rod)
钢管木通心锤

CODE	SIZE (l cm)
5130830	30.4



**White Plastic Rolling Pin
(Seal Stainless Steel Rod)**
钢管通心锤

CODE	SIZE (l cm)
5131030	30



Pastry Brush (Plastic Handle)
胶柄毛油扫

CODE	SIZE		CODE	SIZE	
	(l cm)	inch		(l cm)	inch
2320125	2.5	1.0	2320150	5.0	2.0
2320130	3.0	1.25	2320160	6.0	2.5
2320135	3.5	1.5	2320170	7.0	3.0



Pastry Brush (Bamboo Handle)
竹柄油刷

CODE	TYPE
5131104	4
5131106	6
5131108	8



Star Stainless Steel Piping Nozzle
不锈钢裱花嘴

CODE	SIZE	CODE	SIZE
	(l cm)		(l cm)
5131304	0.4	5131312	1.2
5131306	0.6	5131313	1.3
5131307	0.7	5131315	1.5
5131308	0.8	5131317	1.7
5131310	1.0	5131318	1.8
		5131300	set of 10-pcs



Plain Stainless Steel Piping Nozzle
不锈钢裱花嘴

CODE	SIZE	CODE	SIZE
	(ø cm)		(ø cm)
5131204	0.4	5131212	1.2
5131206	0.6	5131213	1.3
5131207	0.7	5131215	1.5
5131208	0.8	5131217	1.7
5131210	1.0	5131218	1.8
		5131200	set of 10-pcs



Nylon Piping Bag
挤花袋

PIAZZA

CODE	SIZE	CODE	SIZE
	(l cm)		(l cm)
6091825	25	6091850	50
6091828	28	6091855	55
6091834	34	6091865	65
6091840	40	6091870	70
6091846	46		



Cotton Pastry Bag
布花嘴袋

CODE	SIZE
	(l cm)
5131701	27 x 38
5131715	



Stainless Steel Piping Nozzle Set (24 pcs)
24头不锈钢花嘴

CODE
5131524



PP Piping Bag Holder
挤花袋座

PIAZZA

CODE
6091901



Stainless Steel Piano Whisk
(Nylon Handle)
轻巧试尼龙打蛋器



CODE	SIZE	
	(l cm)	(inch)
2150510	26	10
2150512	31	12
2150514	36	14
2150516	41	16
2150518	46	18



Stainless Steel French Whisk
(Nylon Handle)
法式试尼龙打蛋器



CODE	SIZE	
	(l cm)	(inch)
2150610	25	10
2150612	30	12
2150614	35	14
2150616	40	16
2150618	45	18
2150620	50	20
2150622	56	22
2150624	61	24



GOURMET
STEEL

Stainless Steel Water Pail / Bucket
钢水桶

CODE	SIZE		CAP Ltr
	(ø x h cm)		
5132110	30 x 20	24	10
5132113	30 x 25	26	13
5132120	35 x 30	28	20



GOURMET
STEEL

Stainless Steel Egg Mixture Pail
双活耳打蛋桶

CODE	SIZE
	(ø cm)
5131910	30 x 23
5131913	32 x 25
5131915	35 x 28



Thick Good Morning Towel
“祝君早安”毛巾

CODE	PACK
5140100	12 pcs / pkt



Rectangular White Bath Towel
白毛巾

CODE	SIZE	
	(l x w cm)	inch
5140401	68.5 x 137	27 x 54

Thick Cotton Hand Glove
厚棉劳工手套

CODE	SIZE
	(l cm)
5140601	





Rectangular Kitchen Towel 长厨房毛巾

CODE	SIZE		PACK
	(l cm)	inch	
5140200-xx	20	14 x 20	12 pcs / pkt

*Available Colour

■ RD ■ GR ■ BL ■ YE ■ BR

When ordering Red Handle add **CODE** suffix to item number (example: 5140200-RD)



Thick Checked Kitchen Towel 厨房毛巾

CODE	SIZE		PACK	REMARK
	(l cm)	(inch)		
7110101	45 x 71	14 x 28	12 pcs / pkt	Assorted Color



Full Size Thick PVC Apron 全身厚胶围裙

CODE	SIZE
(l cm)	
9111601-xx	1/1

*Available Colour

WH GR BL YE BK BG

When ordering White add **CODE** suffix to item number (example: 9111601-WH)



T / Stripe Cotton Apron 半身无袋围裙

CODE	SIZE
(l cm)	
5140912-xx	1/2

*Available Colour

WH BK

When ordering White add **CODE** suffix to item number (example: 5140912-WH)



Cotton Baby Napkin 全棉婴儿布

CODE	SIZE
(l cm)	
5140501	71



Full Size Cotton Apron (1 Pocket) 全身单袋围裙

CODE	SIZE
(l cm)	
5140811-xx	1/1

*Available Colour

WH BK

When ordering White add **CODE** suffix to item number (example: 5140811-WH)



Long Sleeve Chef Uniform (Knob Button)
长袖厨衣

CODE	SIZE
------	------

5141501	XS
5141502	S
5141503	M
5141504	L
5141505	XL
5141506	XXL
5141507	XXXL



Short Sleeve Chef Uniform (Knob Button)
短袖厨衣

CODE	SIZE
------	------

5141601	XS
5141602	S
5141603	M
5141604	L
5141605	XL
5141606	XXL
5141607	XXXL



Normal White Short Sleeve Uniform
(2-Row White Button)
短袖双行白钮白厨衣

CODE	SIZE
------	------

5141101	S
5141102	M
5141103	L
5141104	XS
5141105	XL
5141106	XXL
5141107	XXXL
5141108	XXXXL



Normal White Long Sleeve Uniform
(2-Row White Button)
长袖双行白钮白厨衣

CODE	SIZE
------	------

5141301	S
5141302	M
5141303	L
5141304	XL
5141305	XS
5141306	XXL
5141307	XXXL



Normal White Short Sleeve Uniform
(2-Row Black Button)
短袖双行黑钮白厨衣

CODE	SIZE
------	------

5141201	S
5141202	M
5141203	L
5141204	XL
5141205	XS
5141206	XXL
5141207	XXXL



Normal White Long Sleeve Uniform
(2-Row Black Button)
长袖双行黑钮白厨衣

CODE	SIZE
------	------

5141401	S
5141402	M
5141403	L
5141404	XL
5141405	XS
5141406	XXL
5141407	XXXL



**Versa Amber Color Pot / Fluted Casserole
With Glass & Plastic Covers**
玻璃碗

CODE	SIZE (l cm)	CAP (lit)
5151101		1.25
5151102		2.25



Fluted Pie Glass Plate
玻璃花边派盘

CODE	SIZE (l cm)	CAP (L)
5150106	20.2 x 3.9	0.6
5150112	21.7 x 4.1	1.2
5150115	24.6 x 4.1	1.5



Wooden Sashimi Boat
木寿司船

CODE	SIZE (l cm)	inch
5150316	40	16
5150318	46	18
5150320	50	20
5150322	55	22



Rectangular Glass Baking Dish
玻璃长方形烤盘

CODE	SIZE (l x w x h inch)	CAP (L)
5151218	16.5 x 26.3 x 4.5	1.7
5151225	19.5 x 31.0 x 4.5	2.4
5151251	22.4 x 35.4 x 4.5	3.0



Round Ice Mold
圆形冰模

CODE	SIZE (l cm)	
5150401	18.5 x 6	Round
5150402	22.5 x 22.5 x 7	Square
5150403	29.0 x 15.5 x 7	Boat
5150404	24.5 x 18.5 x 6	Leaf





Fugui Double Boil Bowl
富贵直身有盖炖盅

CODE	SIZE (ø cm)
5150801	8.3
5150802	10



Sharkfin Bowl
鱼翅盅

CODE	SIZE (ø cm)	inch
5151301	11.5	4.5"



3-Pcs Double Boil Bowl
鱼翅盅

CODE	SIZE (ø cm)	Inch
5150901	13	5"



Square Cast Iron Hotplate
方形铁板

CODE	SIZE (l x w cm)
5160117	17 x 17
5160119	19 x 19



Round Cast Iron Hotplate
有柄圆形铁板

CODE	SIZE (ø cm)
5162515	15
5162520	20



Round Cast Iron Hotplate
有柄圆形铁板

CODE	SIZE (ø cm)
5160217	17



Round Cast Iron Hotplate
有柄圆形铁板

CODE	SIZE (ø cm)
5162613	13
5162616	16



Oval Hotplate
椭圆形铁板带木板

CODE	SIZE (l x w cm)	TYPE (No.)
5160303	13.9 x 24.1	3
5160304	17.0 x 26.0	4
5160305	19.0 x 27.9	5



Cow Shape Cast Iron Hotplate
牛形铁板

CODE	SIZE (l x w cm)
5162701	24 x 16



Round Cast Iron Hotplate
有柄圆形浅铁板

CODE	SIZE (ø cm)
5160401	17.5
5160402	20.5
5160403	23.5



Oval Cast Iron Shallow Hotplate
椭圆形铁板

CODE	SIZE (l x w cm)
5162901	16 x 24



Round Cast Iron Shallow Hotplate
圆形浅铁板

CODE	SIZE (ø cm)	CODE	SIZE (ø cm)
5162818	18	5162826	26
5162822	22	5162828	28
5162824	24	5162832	32



**Oval Cast Iron Shallow Hotplate
(Diamond Edge)**
椭圆形铁板

CODE	SIZE (ø cm)
5163122	22
5163125	25
5163128	28



**Oval Cast Iron Shallow Hotplate
(Design Edge)**
椭圆形铁板

CODE	SIZE (ø cm)
5163001	12 x 19



**Rectangular Cast Iron Shallow
Hotplate**
有柄长方形铁板

CODE	SIZE (l x w cm)
5163301	11 x 16.5
5163302	12 x 18.5
5163303	13 x 21.5
5163304	15.5 x 25.0



**Round Cast Iron Shallow Hotplate
(Line Surface)**
圆线条文铁板

CODE	SIZE (ø cm)
5163224	24
5163226	26



Round Cast Iron Shallow Hotplate
圆形铁板

CODE	SIZE (ø cm)
5163415	15



Rectangular Cast Iron Shallow Hotplate (Slant Edge)
斜边没柄长方形铁板

CODE	SIZE (l x w cm)
5163515	22 x 16



Round Cast Iron Shallow Hotplate (Wide Rim)
圆形铁板

CODE	SIZE (ø cm)
5163615	18
5163618	28



Round Cast Iron Claypot
韩式铁沙锅连盖

CODE	SIZE (ø cm)
5163716	16
5163718	18
5163720	20
5163722	22



Round Cast Iron BBQ Plate (Korea Style)
韩式形铁板

CODE	SIZE (ø cm)
5163826	26



Round Cast Iron Shallow Pot
双耳浅铁锅

CODE	SIZE (ø cm)
5163918	18



Hotplate Set (Aluminium Bowl)
有木架底双烧铁板(铁板+铝锅)

CODE	SIZE (l x w cm)	SIZE (ø cm)
5164001	16.5 x 16.5	Bowl 13



Hotplate Set (Stove Rack)
有木架底双烧铁板(铁板+火锅架)

CODE	SIZE (l x w cm)
5164101	16.5 x 16.5



Wooden Base/Box For Stone Bowl
木板盒用于石头碗

CODE	SIZE (ø cm)
5164314	13.5
5164316	15.5
5164318	17.5



**Enamel Iron Ramen Bowl
(Korean Style)**
搪瓷韩式铁碗

CODE	SIZE (ø cm)
5164215	15
5164217	17
5164219	19



Wooden Base For Stone Bowl
木板盒用于石头碗

CODE	SIZE (ø cm)
5164510	10.5
5164512	12.0
5164514	13.5
5164516	16.0



Round Stone Bowl
搪瓷韩式铁碗

CODE	SIZE (ø x h cm)
5164415	14 x 7
5164416	16 x 8
5164418	18 x 8.5
5164419	19 x 9



Cast Aluminium Claypot
铸铝砂煲

CODE	SIZE (ø cm)
5161605	15.0
5161655	16.5
5161606	18.5
5161607	21.0
5161608	24.5
5161609	27.0

Cast Aluminium Cover
铸铝砂煲盖

CODE	SIZE (Ø cm)
5161705	13.5
5161755	15.0
5161706	16.5
5161707	19.0
5161708	22.5
5161709	25.5



Aluminium Metal Hanging Pot
铁田舍锅

CODE	SIZE (ø cm)
5161817	17
5161819	19



Black Metal Food Warmer
黑色炉脚

CODE	SIZE (ø cm)	
5162401	10.5	S
5162402	11.0	L
5162403	13.0	XL



Round Warmer
圆炉

CODE	SIZE (ø cm)
5164612	12



Square Warmer
方形炉

CODE	SIZE (ø cm)
5164715	15
5164720	20



Gas Cartridge Stove
瓶装煤气炉

CODE	SIZE (l x w x h cm)
5160500	34.3 x 28.4 x 11.3



**Stainless Steel Round Claypot
Warmer Stand**
圆形钢砂煲炉架

CODE	SIZE (ø cm)
5160645	11.4
5160650	12.7
5160660	15.2
5160670	17.7
5160680	20.3



(* Not Suitable for Export)

Gas Cartridge
瓶装煤气

CODE	CAP	SPEC
2310800	250 ml	48 Cans



Shallow Claypot
有盖浅砂煲 (日式)

CODE	SIZE (ø cm)	inch
5160945	11.4	4.0
5160905	12.7	4.5
5160955	13.9	5.0
5160906	15.2	6.0
5160907	17.7	7.0
5160908	20.3	8.0
5160909	22.8	9.0
5160910	25.4	10



Deep Claypot
有盖深砂煲

CODE	SIZE	
	(ø cm)	inch
5162306	15.2	6
5162307	17.7	7
5162308	20.3	8
5162309	22.8	9
5162310	25.4	10



“MUSHROOM” Deep Claypot
“蘑菇”深砂煲

CODE	SIZE	
	(ø x h cm)	
5160728	28 x 9	
5160731	31 x 11	
5160734	34 x 11	
5160738	38 x 12	



“THAI STYLE” Claypot
有盖泰式砂煲

CODE	SIZE		type
	(ø x h cm)		
5161205	21 x 7	5	
5161206	18 x 6	6	
5161207	15 x 5	7	



Black Deep Clay Pot
黑色有盖深砂煲

CODE	SIZE	
	(ø x h cm)	inch
5161105	16 x 5.5	6
5161106	19.5 x 6	8
5161107	22.5 x 7	9
5161108	26.0 x 8	10
5161109	29.5 x 9	12



Yellow Clay Base
泰式砂煲底

CODE	SIZE	
	(ø cm)	
5161300	17.78	

* for Type 6 “Thai Style” claypot use



Thai V-Style Claypot (Black)
泰式双耳砂煲 (黑)

CODE	SIZE	
	(ø x h cm)	inch
5161505	16 x 5.5	6"
5161506	19.5 x 5	8"
5161507	22.5 x 6	9"
5161508	26.0 x 8	10"
5161509	29.5 x 9	32"



Thai V-Style Claypot (White)
泰式双耳砂煲 (白)

CODE	SIZE	
	(ø x h cm)	inch
5161405	16.0 x 5.5	6
5161406	19.5 x 6.0	8
5161407	22.5 x 7.0	9
5161408	26.0 x 8.0	10
5161409	29.5 x 9.0	12



Taiwan Style Soup Claypot (Glass Cover)
台湾式玻璃盖汤砂煲

CODE	SIZE	
	(ø cm)	
5161901	17.2 x 13.4	
5161900	19.4 x 15.1	
5161910	21.2 x 16.8	
5161920	24.3 x 19.9	
5161930	27.3 x 21.5	



Electric Porridge Cooker
电粥桶

CODE	SIZE (l x h cm)	POWER
5170200	50.8 x 80	220V, 6KW



Electric Tart & Pastry Oven
港式局炉

CODE	SIZE (l x w x h cm)	POWER
5170400	73.6 x 60.3 x 48.3	220V, 4.5KW



Electric Changfun Cooker
港式移动型蒸肠粉车

CODE	SIZE (l x w x h cm)	POWER
5170502	93.0 x 62.8 x 80	220V, 3KW X 2
5170503	47.7 x 62.8 x 80	220V, 3KW X 3



Electric Bbq Garden Griller (Wide)
宽型电烧烤炉

CODE	SIZE (l x w cm)	POWER
5170704	37.0 x 55.8	220V, 3KW x 2
5170706	55.8 x 60.9	220V, 3KW x 3



Electric Noodle Cooker with Stand
港式移动型蒸肠粉车

CODE	SIZE (l x h cm)	POWER
5170603	35.5 x 44.4	220V, 3KW x 3



Electric Bbq Garden Griller (Long)
长型电烧烤炉

CODE	SIZE (l x w cm)	TYPE	POWER
5170902	20.3 x 63.5	4 wire	220V, 2 KW
5170903	20.3 x 73.6	4	220V, 3 KW

1/1 Size x 8" Long Electric Deep Fryer 1/1 港制双缸炸炉

CODE	SIZE (l x w x h cm)	CAP (L)	POWER
5171001	55.3 x 46 x 35.8	1 x 18	220V, 3KW X 2
5171002	55.3 x 46 x 35.8	2 x 9	220V, 3KW X 3

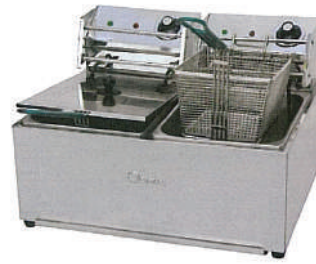

1/3 x 8" Single Electric Deep Fryer 1/3 X 8" 单头炸炉

CODE	SIZE (l x w x h cm)	CAP (L)	POWER
5171113	18 x 41.9 x 27.9	5	220V, 2.2KW



1/2 Size x 8" Single Electric Deep Fryer 1/2 X 8" 单头炸炉

CODE	SIZE (l x w x h cm)	CAP (L)	POWER
5171112	26.9 x 44.7 x 33	8	220V, 3KW



Electric Table Top Griddle 电平扒炉

CODE	SIZE (l x w x h cm)	POWER
5171211	27.9 x 38.0 x 24.0	220V, 2KW
5171216	30.4 x 38.0 x 24.0	220V, 2KW
5171218	45.7 x 42.5 x 22.8	220V, 3KW
5171220	52.7 x 42.5 x 22.8	220V, 3KW
5171222	55.8 x 42.5 x 22.8	220V, 4KW
5171224	60.9 x 45.7 x 22.8	220V, 5KW



2/3 x 8" Single Electric Deep Fryer 2/3 X 8" 单头炸炉

CODE	SIZE (l x w x h cm)	CAP (L)	POWER
5171123	36.8 x 44.7 x 36	13	220V, 2KW x 2



Electric Salamander 电面火炉

CODE	SIZE (l x w x h cm)	POWER
5171403	60 x 30 x 31	220V, 3KW
5171404	69 x 35 x 38	220V, 2KW x 2

Electric Table Top Griddle with 1 Side Groove Grill 电平扒炉

CODE	SIZE (l x w x h cm)	POWER
5171321	55.8 x 42 x 22.8	220V, 3KW



Wall Mounted Electric Water Heater
电煮水器

CODE	SIZE (l x w x h cm)	CAP gal	POWER
5171506	35.0 x 30 x 56.0	6	220V, 2KW
5171508	35.5 x 23 x 61.5	8	220V, 2.5KW
5171510	40.0 x 25 x 67.0	10	220V, 3KW



Electric Water Heater
电煮水器

CODE	SIZE (l x w x h cm)	CAP gal	POWER
5171615	43.0 x 28.0 x 81	15	220V, 2KW
5171620	46.0 x 30.5 x 92	20	220V, 2KW
5171630	55.8 x 38.0 x 112.3	30	220V, 3KW
5171640	60.9 x 40.6 x 116.8	40	220V, 3KW



Electric Coffee / Tea Urn (2 Tap)
二管型煮咖啡炉

CODE	SIZE (l x w x h cm)	CAP gal	POWER
5171806	38 x 30.5 x 48.3	6	220V, 3KW
5171808	48.3 x 28 x 66.0	8	220V, 5KW



Stainless Steel Water Heater Stand
电煮水器用底座

CODE	SIZE (l x w x h cm)	CAP gal
5171715	43.2 x 46.9 x 78.7	15
5171720	45.7 x 50.8 x 78.7	20
5171730	55.8 x 55.8 x 78.7	30
5171740	60.9 x 60.9 x 78.7	40



Electric Coffee / Tea Urn (3 Tap)
三管型煮咖啡炉

CODE	SIZE (l x w x h cm)	CAP gal	POWER
5171906	38.0 x 30.5 x 48.3	6	220V, 3KW
5171908	48.3 x 33.8 x 63.0	8	220V, 5KW
5171910	50.8 x 35.0 x 66.0	10	220V, 6KW



Electric Rice Cooker (Stainless Steel Body)
电饭锅

CODE	SIZE (l x w x h cm)	CAP (L)	POWER
5172106	42.6 x 42.6 x 39.8	8	220V, 1650W



Electric Rice Cooker
电饭锅

CODE	CAP (L)
5172042	4.2
5172056	5.6
5172078	7.8
5172098	10



Rice Cooker
煤气饭锅 (罐装煤气)

Rinnai

CODE	CAP (L)	type
5172355	10	LPG
5172455	10	PUB



Electric Rice Cooker
电饭锅

CODE	SIZE (l x w x h cm)	CAP (L)	POWER
5172210	57 x 57 x 38	10	220V, 3200W



Electric Soup Warmer
电保温汤桶

CODE	CAP (L)
5172600	12



Electric Soup Warmer
电保温汤桶

CODE	SIZE (ø x h cm)	CAP QT	POWER
5172500	38 x 37	11.8QT	220V / 50Hz



Stainless Steel Electric Rice / Soup Warmer
钢电保温饭/汤桶

CODE	SIZE (ø x h cm)	inch	CAP (L)	POWER
5172940	40	16.0	40	1.5KW
5172945	47	18.5	45	1.5KW
5172950	53	21.0	50	1.5KW



Electric Rice Warmer (Stainless Steel Body)
电保温饭桶

CODE	CAP (L)
5172808	9.6
5172708	8.0

**Refer to Equipment Section for more option*



Electric Meat Mincer
电动搅肉机

CODE	POWER
5173011	1 - HP
5173012	1 / 2 - HP
5173034	3 / 4 - HP



Electric Dough Mixer
电搅面粉机

CODE	CAP (L)
5173110	10
5173115	15
5173120	20



* Safety Net
Not Included

Electric Dough Mixer
电动搅拌器 (不带安全网)

CODE	CAP (L)
5173525	25



* Safety Net
Not Included

Electric Dough Mixer
电动搅拌器

CODE	CAP (L)
8080130	30
8080134	40



Table Top Dough Mixer without Guard
电动搅拌器

CODE	CAP QUART	POWER
5173205	5	230V / 50HZ



Table Top Dough Mixer
电动搅拌器

CODE	CAP QUART	POWER
5173408	8	230V / 50HZ

**Refer to Equipment Section for Full Specification of above products*

- Stainless steel base
- Piston/rod system carriage motion
- Fan-cooled carriage motion motor with commercial-grade oil bath reduction
- Blade and carriage motion powered by separate controls
- An easily accessible switch arm can convert the unit from automatic to manual operation
- The exclusive designed carriage "Nettuno" is available with a special end weight and an adjustable vertical product fence to provide stability and advance products evenly.
- Motor: watt 370+180 - Hp 0,50+0,24



Semi Automated Meat Slicer
自动电切肉片机



CODE	SIZE (l x w x h cm)	REMARKS Blade Dimension
5173800	68.5 x 66 x 67	350 mm

- Rounded design, no sharp edges and visible screws.
- Chrome plated and ground slide rod.
- Lapped cast iron slide rod bushing.
- Vulcanized rubber stops on carriage.
- Removable support cover for thickness gauge plate.
- Stainless steel slice deflector with bayonet fitting.
- Stainless steel screws and fittings.
- 49,5 mm distance between blade and motor.
- Bottom cover.
- Changeover electronic circuit 110-220-380 V single and three phase.
- Built in sharpening tool with bottom protection.
- Standard blade removal tool.
- 35° blade inclination
- Plastic knob.
- Plastic pushbuttons with IP67 protection rating.
- Enclosed and sealed worm gear reduction unit. Oil bath lubrication.
- Motor: watt 400 - Hp 0,54



Electric Meat Slicer
电切肉片机



CODE	SIZE (l x w x h cm)	REMARKS Blade Dimension
5173900	66 x 57.5 x 45.5	350 mm



Manual Meat Slicer
切肉片机



CODE	SIZE (l cm)
5173622	22
5173625	25
5173630	30

**Refer to Equipment Section for Full Specification of above products*



Stainless Steel Dim Sum Trolley
(Gas Stove)
钢竹笼点心车 (燃气式)

CODE	SIZE
	(l x w x h cm)
5180100	78 x 44 x 88



Stainless Steel INSULATED Dim Sum Trolley (Glass Door)
钢点心车 (燃气式)

CODE	SIZE
	(l x w x h cm)
5180200	80 x 48 x 115



Stainless Steel Dim Sum Trolley
钢点心车 (标准型)

CODE	SIZE
	(l x w x h cm)
5181600	80 x 48 x 100



Stainless Steel Pan Fried Trolley
钢煎炸车 (燃气式)

CODE	SIZE
	(l x w x h cm)
5181700	78 x 43 x 121



Stainless Steel Porridge Trolley
钢粥 / 甜品 (燃气式)

CODE	SIZE	TYPE
	(l x w x h cm)	
5181800	78 x 44 x 88	4-Compartment
5181806	78 x 44 x 88	6-Compartment



Stainless Steel Cheong Fun Trolley
钢肠粉车 (燃气式)

CODE	SIZE
	(l x w x h cm)
5181900	78 x 44 x 88



Plastic Food Container
胶食品容器

CODE	SIZE (l x w x h cm)
9012501	19.0 x 19.0 x 7.7
9012502	21.5 x 21.5 x 8.8
9012503	24.0 x 24.0 x 10
9012504	28.0 x 28.0 x 11



Rectangular Plastic Container
长方形胶盒

CODE	SIZE (l x w x h cm)	CAP
5180431	12.5 x 8.8 x 4.0	280 ml
5180432	15.2 x 10.8 x 5.0	530 ml
5180433	17.9 x 12.8 x 5.8	910 ml
5180434	20.6 x 14.8 x 6.8	1.4 L
5180435	22.7 x 15.6 x 9.1	2.2 L
5180436	25.6 x 17.9 x 9.8	3.3 L
5180437	30.3 x 20.7 x 10.7	5.0 L
5180438	34.3 x 23.5 x 11.6	7.0 L
5180439	39.6 x 26.7 x 12.6	10.0 L



Rectangular Plastic Container
长方形胶盒

CODE	SIZE (l x w x h cm)	CAP
9013401	11.7 x 7.9 x 4.6	260 ml
9012801	15.3 x 11.0 x 5.8	550 ml
9012802	17.8 x 13.0 x 7	950 ml
9012803	20.2 x 14.5 x 9	1.83 L
9012804	31.0 x 22.5 x 11	4.90 L
9012805	27.8 x 20.0 x 10	3.65 L
9012806	34.5 x 24.5 x 12	7.45 L



Square Plastic Container (Transparent)
方形胶盒

CODE	SIZE (l x w x h cm)
9013601	11 x 11 x 9



Plastic Air-Sealed Container
密封胶食品容器

CODE	SIZE (l x w x h cm)	SPEC
9012601	15.2 x 11.0 x 9.3	0.94
9012602	17.5 x 12.7 x 11.6	1.75
9012603	19.6 x 14.2 x 14.0	2.75
9012701	27.8 x 16.5 x 13.8	



Rectangular Plastic Container
长方形胶盒

CODE	SIZE (l x w x h cm)	CAP (L)
5180540	15.2 x 10.5 x 9.3	1.0
5180541	17.8 x 12.5 x 10.7	1.7
5180542	20.6 x 14.8 x 13.0	2.8
5180543	26.0 x 17.9 x 15.3	5.2
5180544	30.1 x 20.7 x 16.5	7.9
5180545	34.3 x 23.9 x 17.7	11.0
5180546	39.6 x 26.7 x 19.0	15.8

CHINESE KITCHEN

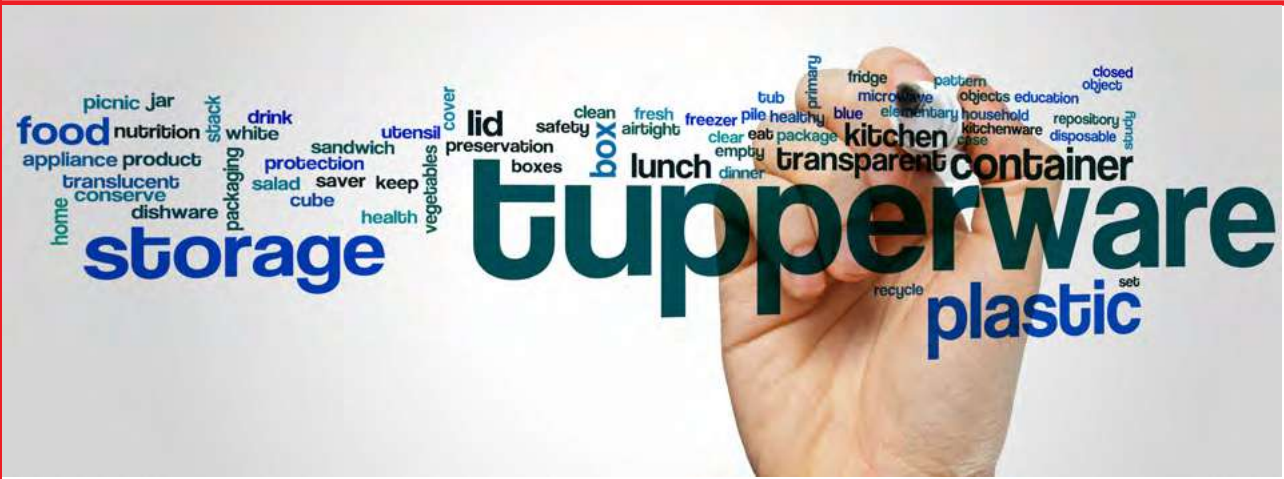

Rectangular Plastic Container
长方形胶盒

CODE	SIZE (l x w x h cm)	CAP (lit)
5180701	21.3 x 14.5 x 6.6	1.3
5180702	25.0 x 19.0 x 9.0	2.6
5180704	30.0 x 23.0 x 10.0	4.5
5180708	35.0 x 28.0 x 12.0	8.0
5180713	40.0 x 32.0 x 14.0	12.5



Plastic Transparent Round Container
圆形透明胶桶

CODE	SIZE (ø x h cm)
5180901	12.0 x 5.5
5180902	17.5 x 16.5
5180903	22.5 x 22.5
5180904	19.5 x 19.5
5180905	14.0 x 14.0
5180906	14.0 x 8.0
5180907	17.5 x 9.5
5180908	12.0 x 10.0
5180909	19.5 x 11.5

Storage Container with Cover
胶盒



CODE	SIZE (l x w x h cm)
9014101-xx	44 x 30.2 x 20

*Available Color

■ GR ■ BL

CODE	SIZE (l x w x h cm)
9014201-xx	49.2 x 35 x 27.2

*Available Color

■ GR ■ BL

CODE	SIZE (l x w x h cm)
9014001-xx	56 x 39.5 x 30

*Available Color

■ RD ■ BL

When ordering Red add **CODE** suffix to item number (example: 9014001-RD)



Stackable Container 工业箱



CODE	SIZE (l x w x h cm)
------	------------------------

5181210-xx 42 x 32 x 9

CODE	SIZE (l x w x h cm)
------	------------------------

5181211-xx 64 x 42 x 9

5181212-xx 64 x 42 x 16

Cover

9014701 65.5 x 42.5 x 2.0



Side Hole



CODE	SIZE (l x w x h cm)
------	------------------------

9014801-14 63 x 37 x 13.5

Shallow



CODE	SIZE (l x w x h cm)
------	------------------------

9014901-xx 53 x 40 x 6.7
9014902-xx 53 x 40 x 8.6
9014903-xx 53 x 40 x 10

Cover

9015001

*Available Colour

■ YE ■ GY

When ordering Grey add **CODE** suffix to item number (example: 9014901-GY)

CODE	SIZE (l x w x h cm)
------	------------------------

9015101-xx 34.5 x 27 x 12.7

*Available Color

■ BL ■ GY

When ordering Grey add **CODE** suffix to item number (example: 9015101-GY)



CODE	SIZE (l x w x h cm)
------	------------------------

9015201-xx 55 x 42.5 x 24

Cover

9015301

*Available Color

■ BL ■ GY

When ordering Grey add **CODE** suffix to item number (example: 9015301-GY)

CODE	SIZE (l x w x h cm)
------	------------------------

9015401-xx 43 x 26.5 x 13

*Available Color

■ BL ■ GY

When ordering Grey add **CODE** suffix to item number (example: 9015401-GY)

CODE	SIZE (l x w x h cm)
------	------------------------

9015501-xx 46 x 36 x 15

Cover

9015601 46 x 36 x 3

*Available Color

■ BL ■ GY

When ordering Grey add **CODE** suffix to item number (example: 9015401-GY)

CHINESE KITCHEN

Stackable Container 工业箱



Perforated Side



CODE	SIZE (l x w x h cm)
9015701-RD	59.5 x 39.0 x 19.0

CODE	SIZE (l x w x h cm)
9015901-xx	60 x 45 x 22.0
9015902-xx	60 x 45 x 32.5

CODE	SIZE (l x w x h cm)
9016101-xx	66 x 45 x 23
9016201-xx	66 x 45 x 38

Cover
9016001 61 x 46 x 3

Cover
9016301 67 x 46 x 2

*Available Colour

■ BL ■ GY ■ YE

*Available Colour

■ BL ■ GY ■ YE ■ RD

When ordering Grey add **CODE** suffix to item number (example: 9016101-GY)



Stackable Container with Metal Handle 有柄工业箱

CODE	SIZE (l x w x h cm)
9016401-xx	70 x 49 x 43

*Available Colour

■ BL ■ RD ■ GR

When ordering Red add **CODE** suffix to item number (example: 9016401-RD)



Space Saver Box 工业箱

CODE	SIZE (l x w x h cm)
9016701-GY	50 x 31 x 28.5
9016601-GY	50 x 31 x 20.6





Rectangular Utility Tray (Large Hole)
长方胶筛

CODE	SIZE (l x w x h cm)
5181701-xx	40.2 x 31.3 x 11.2
5181702-xx	52.0 x 39.8 x 17.0

***Available Colour**

■ BL ■ RD ■ GR ■ GY ■ YE

When ordering Red add **CODE** suffix to item number
(example: 5181701-RD)



Rectangular Utility Tray (Small Hole)
长方胶筛

CODE	SIZE (l x w x h cm)
5181601-xx	27.4 x 20.7 x 7.4
5181602-xx	36.0 x 26.2 x 9.5
5181603-xx	41.5 x 30.0 x 10.2
5181604-xx	46.9 x 33.0 x 10.7

***Available Colour**

■ BL ■ RD ■ GR ■ GY ■ YE

When ordering Red add **CODE** suffix to item number
(example: 5181601-RD)



Round Utility Tray
圆胶筛

CODE	SIZE (ø cm)
5182001-xx	24.5
5182002-xx	28.2
5182003-xx	31
5182004-xx	34
5182005-xx	39

***Available Colour**

■ BL ■ RD ■ GR ■ GY ■ YE

When ordering Red add **CODE** suffix to item number
(example: 5181601-RD)



Small Utility Tray
小胶筛

CODE	SIZE (l x w x h cm)	
5181801-xx	13.8 x 9.3 x 5.0	Rectangular
5181901-xx	15.2 x 15.2 x 8.0	Square

***Available Colour**

■ BL ■ RD ■ GR ■ GY ■ YE

When ordering Red add **CODE** suffix to item number
(example: 5181801-RD)



Rectangular Plastic Colander
长方胶筛

CODE	SIZE (l x w x h cm)	
5181304	30.9 x 22.6 x 8.3	
5181305	35.5 x 26.4 x 9.7	
5181306	40.9 x 30.0 x 10.8	
5181307	46.9 x 33.9 x 10.6	
5181308	47.4 x 36.4 x 12.5	
5181310	50.3 x 40.8 x 15.8	
5181366	50 x 40 x 18	Large Hole
5181399	59 x 47 x 21	Large Hole



Round Plastic Colander
圆胶筛

CODE	SIZE (Ø cm)
5181515	15.0
5181516	17.5
5181517	22.0
5181518	27.5
5181519	26.0
5181520	30.5
5181521	35.0
5181522	39.0

CHINESE KITCHEN



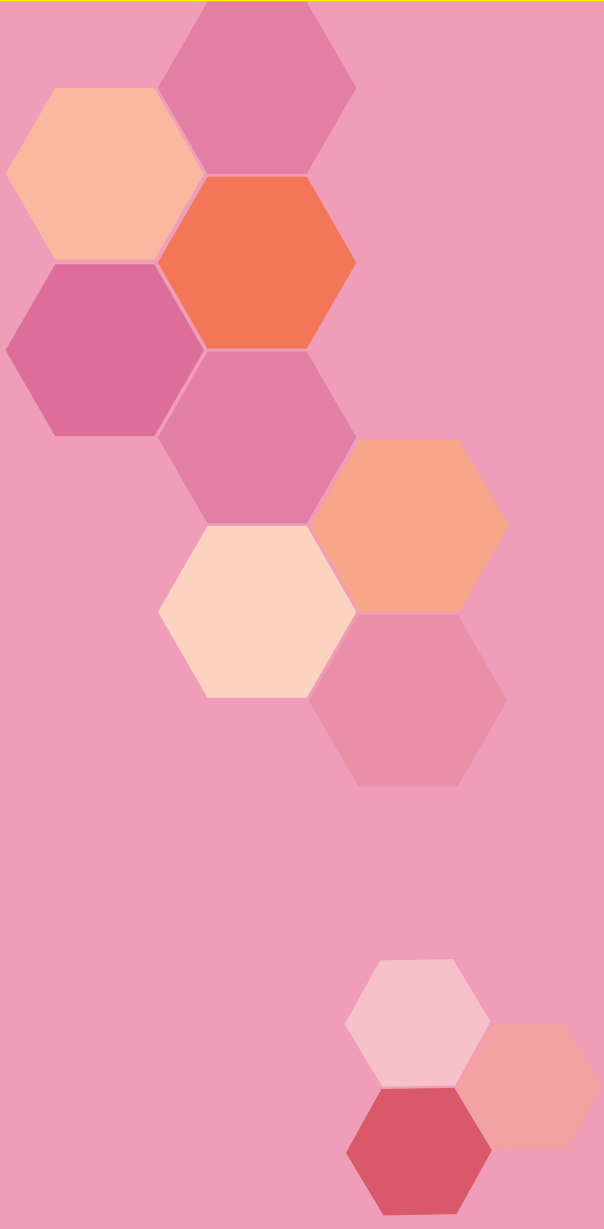

Japanese Kitchen



JAPANESE KITCHEN



Cast Iron Hanging Pot with Wooden Cover
木盖生铁提锅

CODE	SIZE (ø cm)	CODE	SIZE (ø cm)
A1070715	15	A1070724	24
A1070716	16	A1070727	27
A1070718	18	A1070730	30
A1070721	21		



Square Cast Iron Hanging Pot
木盖方形生铁提锅

CODE	SIZE (ø cm)
A1070813	13
A1070815	15



Cast Iron Hanging Pot
木盖生铁提锅

CODE	SIZE (ø cm)
A1070916	16
A1070918	18



Cast Iron Sukiyaki Pot
铸铁寿喜烧锅

CODE	SIZE (ø cm)
A1071018	18
A1071026	26
A1071030	30



Cast Iron Stove with Fuel Holder
生铁炉脚/燃料杯

CODE	SIZE (ø x h cm)
A1080313	13 x 9
A1080317	17 x 9



Black Metal Food Warmer
黑色炉脚

CODE	SIZE (ø cm)
5162401	10.5
5162402	11.0
5162403	13.0



Square Warmer
方形炉脚/燃料杯

CODE	SIZE (l x w cm)
5164715	15 x 15
5164720	20 x 20



Economy Square Cooking Furnace
方形日式风炉

CODE	SIZE (l x w cm)
A1080207	12 x 12
A1080208	15 x 15
A1080220	18 x 18



Square Cooking Furnace
方形日式风炉

CODE	SIZE (l x w cm)
A1080101	12 x 12
A1080102	15 x 15
A1080103	18 x 18
A1080104	21 x 21



Square Wire Net
方形线网

CODE	SIZE (l x w cm)
A1080609	11.5 x 11.5
A1080610	12.5 x 12.5
A1080611	15.0 x 15.0
A1080612	22.0 x 22.0



Stainless Steel Wire Steamboat Net
钢线火锅网

CODE	SIZE (ø cm)	
A1080701	18.0	L
A1080702	15.5	S



"Shobido" Tempura Paper
天妇罗纸

CODE	SIZE (l x w cm)	SPEC
A1180301	20 x 22	100 Pcs
A1180302	20 x 22	500 Pcs



Individual Solid Cube Heating Fuel
蜡

CODE	CAP	SPEC
4020610	10gr	(10gr x 20pcs / pkt, 36pkts /ctn)
4020620	20gr	(20gr x 20pcs / pkt, 20pkts /ctn)



Gas Cartridge Stove
瓶装煤气炉

CODE	SIZE (l x w x h cm)
5160500	34.3 x 28.4 x 11.3



Blow Touch (Use with Cartridge Gas)
煤气炉用罐装煤气

CODE	SIZE (l x w x h cm)
2310700	34.3 x 28.4 x 11.3



GAS CARTRIDGE
瓶装煤气

CODE	CAP	SPEC
2310800	48 Can	250ml

JAPANESE KITCHEN



Copper Tempura Pan
铜炸天妇罗锅

CODE	SIZE (Ø cm)	CODE	SIZE (Ø cm)
A1110830	30	A1110839	39
A1110833	33	A1110842	42
A1110836	36	A1110845	45



Black Steel Tempura Pan
黑炸天妇罗锅

CODE	SIZE (Ø cm)	CODE	SIZE (Ø cm)
A1110730	30	A1110739	39
A1110733	33	A1110742	42
A1110736	36	A1110745	45



Aluminium Cooking Pot with 2 Handle
双耳无盖铝锅

CODE	SIZE (Ø cm)	CODE	SIZE (Ø cm)
A1110630	30	A1110645	45
A1110633	33	A1110648	48
A1110636	36	A1110651	51
A1110639	39	A1110654	54
A1110642	42	A1110660	60



Aluminium Yukihiro Pan / Saucepan
铝单柄锅

CODE	SIZE (l x w x h cm)	CODE	SIZE (l x w x h cm)
5010015	15.0	5010022	22.5
5010016	16.0	5010024	24.0
5010018	18.0	5010027	27.0
5010019	19.5	5010028	28.0
5010021	21.0	5010030	30.0



Wooden Cover
木锅盖

CODE	SIZE (Ø Inch)	CODE	SIZE (Ø Inch)
A1110910	10"	A1110915	15"
A1110911	11"	A1110916	16"
A1110912	12"	A1110917	17"
A1110913	13"	A1110918	18"
A1110914	14"		



Heavy Duty Aluminium Nabe Bowl / Pan
铝无柄雪平锅

CODE	SIZE (Ø Inch)	CODE	SIZE (Ø Inch)
A1111015	15	A1111024	24
A1111018	18	A1111026	26
A1111020	20	A1111027	27
A1111021	21	A1111030	30



Rectangular Copper Frying Pan
长形铜平底煎锅

CODE	SIZE (l x w x h cm)
5010313	13.5 x 18
5010315	15 x 19.5
5010316	16.5 x 21



Square Copper Frying Pan
方形铜平底煎锅

CODE	SIZE (l x w cm)
5010218	18 x 18
5010221	21 x 21
5010224	24 x 24



Stainless Steel Square Steamer
不锈钢方形蒸笼

CODE	SIZE	
	(l x w cm)	Inch
5040928	28 x 28	11.0
5040930	30 x 30	12.0
5040933	33 x 33	13.0
5040936	36 x 36	14.0
5040939	39 x 39	15.0
5040942	42 x 42	16.5
5040945	45 x 45	18.0
5040950	50 x 50	19.0
5040960	60 x 60	23.0



Stainless Steel Square Tofu Tray
方形钢豆腐盆

CODE	SIZE	
	(l x w x h cm)	
A1110115	15 x 15 x 4.5	
A1110118	18 x 18 x 4.5	
A1110121	21 x 21 x 4.5	
A1110124	24 x 24 x 5.0	
A1110127	27 x 27 x 5.0	
A1110130	30 x 30 x 5.0	



Aluminium Donburi Pan
L形铝亲子锅

CODE	SIZE
	(Ø cm)
A1110201	16.5

Cover

A1110202



Hk Iron Wok with One Wooden Handle
香港单柄铁锅

CODE	SIZE	
	(Ø cm)	Inch
5012613	33.0	13
5012614	35.5	14
5012615	38.0	15
5012616	40.6	16



Tako Ball Picker
TAKO球插

CODE	SIZE
	(l x w x h cm)
A1110401	



Round Oil Brush for Tako Ball
线油刷头

CODE	SIZE
	(l x w x h cm)
A1110501	35

Refill Brush

A1110502

Heavy Duty Nabe Plier / Tong
夹子

CODE	SIZE
	(l cm)
3120422	22



JAPANESE KITCHEN



Silicon Burnt Proof Pad for Rice Cooker
煮饭胶片

CODE
A1100201



Rice Cloth
饭巾

CODE	SIZE (l x w cm)
A1100101	110 x 108



**Spare Inner Plastic Tray only for SP-20D,
Blue Sushi Container**
长方寿司包温箱内盒

CODE	SIZE (l x w x h cm)	CAP	SPEC
A1100403	37.0 x 29.5 x 4.5		



**SP-20D Rectangular Insulated Sushi
Container**
长方寿司包温箱

CODE	SIZE (l x w x h cm)	CAP	SPEC
A1100401	48 x 37 x 25.5		



Sushi Wooden Basin with Cover
有盖寿司盆

CODE	SIZE (Ø cm)	CAP	SPEC
A1100327	27		
A1100330	30		
A1100336	36		

Cover
A1100402



Sushi Wooden Basin
有盖寿司盆

CODE	SIZE (Ø x h cm)
A1120201	18 x 12
A1120202	21 x 15
A1120203	25 x 21



Wooden Sushi Basin
木寿司盆

CODE	SIZE (Ø cm)	CODE	SIZE (Ø cm)
A1120133	33	A1120151	51
A1120136	36	A1120154	54
A1120139	39	A1120160	60
A1120142	42	A1120166	66
A1120145	45	A1120172	72
A1120148	48	A1120175	75



Wooden Sushi Rice Ladle
木寿司勺

CODE	SIZE (l cm)
A1120348	48



Economy Wooden Sushi Rice Ladle
木寿司勺

CODE	SIZE (l cm)
A1120450	50



Bamboo Turner (Flat Head)
竹铲(平头)

CODE	SIZE (l x w cm)
2140384	30 x 7



Bamboo Turner (Curve Head)
竹铲(弯头)

CODE	SIZE (l x w cm)
2140388	30 x 7



Bamboo Rice Scoop
竹饭匙

CODE	SIZE (l x w cm)
2140382	23 x 7.5



Plastic Rice Scoop
胶饭匙

CODE
2140422



Plastic Rice Scoop
胶饭匙

CODE	SIZE (l cm)	Inch
A1120512	30	12
A1120518	45	18
A1120524	60	24



Pastry / Oil Brush
油刷

CODE	SIZE (w cm)	Inch
A1120701	4.0	1.50
A1120801	5.5	2.25

Stainless Steel Sauce Container
钢酱料桶

CODE	SIZE (l x w cm)
A1120601	9 x 9



JAPANESE KITCHEN



Wooden Sushi Mould (Assorted Design)
寿司模

CODE	SIZE (l x w x h Inch)	SPEC
A1131301	-	5 Hole



Wooden Sushi Mould (Assorted Design)
寿司模

CODE	SIZE (l x w x h Inch)	SPEC
A1131302	-	3 Holes



“Ground” Wooden Sushi Mould with Pusher
葫芦形木寿司模

CODE	SIZE (l x w x h cm)
A1131304	-



Bamboo Design PVC Sushi Mould
寿司模

CODE	SIZE (l x w x h cm)
A1131402	-



Gourd Design PVC Sushi Mould
寿司模

CODE	SIZE (l x w x h cm)
A1131404	-



Wooden Sushi Maker
木寿司箱

CODE	SIZE (l x w x h Inch)
A1121102	14.0 x 5.5 x 5.5
A1121103	18.0 x 5.5 x 5.0
A1121104	15.3 x 7.5 x 5.0



“Fan” Wooden Sushi Mould with Pusher
扇形木寿司模

CODE	SIZE (l x w x h cm)
A1131303	-



“Mei” Wooden Sushi Mould with Pusher
梅形木寿司模

CODE	SIZE (l x w x h cm)
A1131305	-



Song Design PVC Sushi Mould
寿司模

CODE	SIZE (l x w x h cm)
A1131401	-



Plum Design PVC Sushi Mould
寿司模

CODE	SIZE (l x w x h cm)
A1131403	-

White PVC Sushi Maker/ Mould 寿司模

CODE	SIZE (l x w x h Inch)
A1121201	14.0 x 5.4 x 5.0
A1121202	18.0 x 5.5 x 5.0
A1121203	18.0 x 5.5 x 5.0
A1121204	15.7 x 7.9 x 5.0



20-Pcs PVC Nigiri Sushi Maker 寿司模

CODE	SIZE (l x w x h cm)
A1131501	-

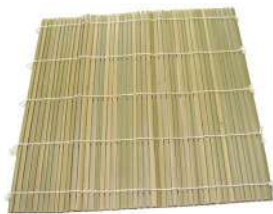

Flat Bamboo Sushi Mat “平”竹寿司片

CODE	SIZE (l x w cm)
A1131727	27 x 27
A1131724	24 x 24



Bamboo Sushi Mat (Square, Flat) 寿司竹片(方形, 平形)

CODE	SIZE (l x w cm)	SPEC
A1131901	12 x 12	Square
A1131902	24	Flat



Stainless Steel Sashimi Chopstick 鱼生筷子

CODE	SIZE (l cm)
A1132015	15.0
A1132016	16.5
A1132018	18.0

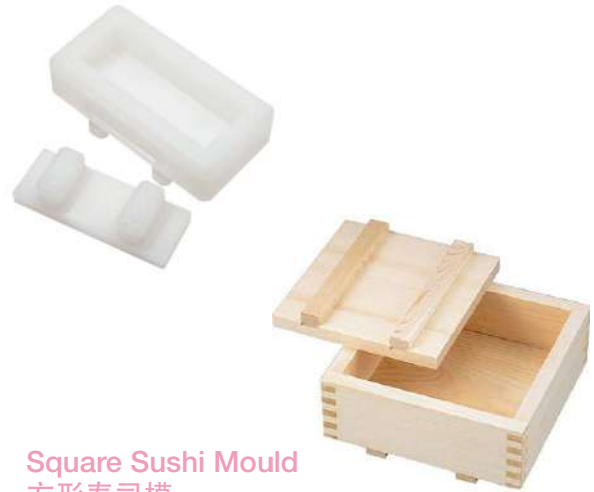

Square Sushi Mould 方形寿司模

CODE	SIZE (l x w cm)
A1131615	15 x 15
A1131618	18 x 18



Small Size Bamboo Sushi Mat with Spoon 竹寿司片

CODE	SIZE (l x w x h cm)
A1131801	-



Bamboo Sushi Mat (Round) 寿司竹片(圆形)

CODE	SIZE (Ø cm)	SPEC
A1131903	24	Round



1/2 Size Stainless Steel Nori Box 钢海苔干燥箱

CODE	SIZE (l x w x h cm)
A1132101	-

JAPANESE KITCHEN

Masamoto Japanese Knife

Carbon Steel Yanagi Knife 刺身庖丁

A1140124 24 cm
A1140127 27 cm
A1140130 30 cm



Carbon Steel Deba Knife 出刃庖丁

A1140316 16.5 cm
A1140318 18.0 cm



Yanagi Knife 刺身庖丁

A1140230 30 cm



Deba Knife 出刃庖丁

A1140418 18.0 cm
A1140419 19.5 cm



Stainless Steel Yanagi Knife 刺身庖丁

A1140512 12 cm
A1140513 13 cm



Sashimi Knife 寿司刀

A1140724 24 cm
A1140727 27 cm
A1140730 30 cm



Carbon Steel Sashimi Knife 刺身庖丁

A1140801 21 cm



Stainless Steel Yanagi/ Sashimi Knife 刺身庖丁



A1140921	21 cm
A1140924	24 cm
A1140927	27 cm
A1140930	30 cm

Deba Knife 出刃庖丁



A1141116	16.5 cm
A1141118	18.0 cm

Carbon Steel Deba Knife 出刃庖丁



A1141215	15 cm
----------	-------

Stainless Steel Deba Knife 出刃庖丁



A1141316	16.5 cm
A1141318	18 cm

Vegetable Cutting Knife 薄刃庖丁



A1141415	15.0 cm
A1141416	16.5 cm
A1141418	18.0 cm

Carbon Steel Vegetable Cutting Knife 薄刃庖丁



A1141516	16.5 cm
----------	---------

JAPANESE KITCHEN



Green Sharpening Stone
青色磨刀石

CODE	SIZE (l x w x h Inch)
3041000	8" x 2" x 2"
Roughness: 200	



Yellow Sharpening Stone
磨刀石

CODE	SIZE (l x w x h cm)
3041100	20.3 x 7.6 x 2.5
Roughness: 4000	



Orange Sharpening Stone
磨刀石

CODE	SIZE (l x w x h cm)
3041200	20.3 x 7.6 x 5
Roughness: 1000	



Benriner Side Turning Vegetable Slicer
旋转式鱼生刨

CODE	SIZE (l x w x h cm)
2380200	

Spare Blade
刨式鱼生刨刀

CODE	SPEC
2381401	Straight Blade
2381402	Fine Teeth Blade

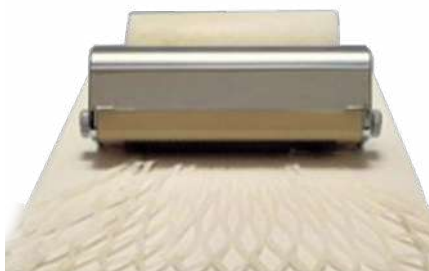

Roller Cutter For Raddish "Fish Net"
“渔网”萝卜切割器

CODE	SIZE (l x w x h cm)
2380500	-

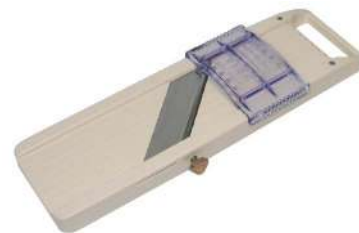

Benriner Vegetable Slicer
鱼生刨

CODE	SIZE (l x w x h cm)
2380100	Small
2380101	Combo

Spare Blade
刨式鱼生刨刀

CODE	SPEC
2381301	Straight Blade
2381302	Fine Teeth Blade
2381303	Med Rough Teeth Blade
2381304	Rough Teeth Blade

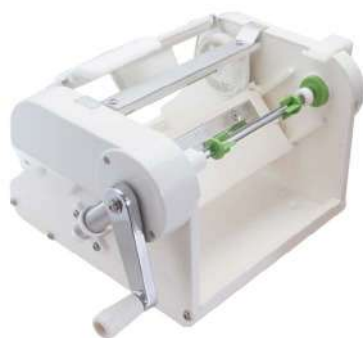

Vegetable Slicer
蔬菜切割器

CODE	SIZE
2380400	Normal
2380421	2 in 1
2380431	3 in 1



2380431



40Deg Angled Kitchen Pincer
不锈钢夹

PIAZZA

CODE	SIZE (l cm)
2222430	30.0
2222423	23.5
2222415	15.0



Straight Kitchen Pincer
不锈钢夹

PIAZZA

CODE	SIZE (l cm)
2222330	30.0
2222323	23.5
2222315	15.0



“Cranked” Tweezer
不锈钢夹

triangle®

CODE	SIZE (l cm)
2222915	15.0



“Cranked” Tweezer
不锈钢夹

triangle®

CODE	SIZE (l cm)
2222935	35.0

“Straight” BBQ Tweezer
不锈钢夹

triangle®

CODE	SIZE (l cm)
2222830	30.0



Nikken Stainless Steel Tweezer
钢鱼骨钳

CODE	SIZE (l cm)
3120110	10.5
3120112	12.0



Kaiman Fish Bone Pincer
不锈钢夹

PIAZZA

CODE	SIZE (l cm)
2222518	18



Copper Fish Scaler with Wooden Handle
木柄鱼鳞刮

CODE	SIZE (l cm)
3130416	16.0
3130418	18.5



Stainless Steel Fish Picker
鱼插

CODE	SIZE (l cm)
A1150115	15



Stainless Steel Oyster Opener with Wooden Handle (Regular)
木柄钢开蚝刀(短头)

CODE	SIZE (l x w x h cm)
3060600	-



Stainless Steel Oyster Opener with Wooden Handle (Long Tip)
木柄钢开蚝刀(长头)

CODE	SIZE (l x w x h cm)
3060500	-



Stainless Steel Japanese Raddish Grater
钢磨萝卜丝板

CODE	SIZE
2371802	2
2371803	3
2371804	4
2371805	5

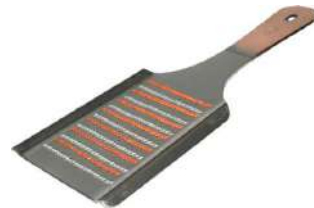

Copper Japanese Raddish Grater
铜磨萝卜丝板

CODE	SIZE
2371714	2
2371713	3
2371712	4
2371711	5
2371709	6
2371706	7



Stainless Steel Round Vegetable Colander Strainer
钢圆形菜筛

CODE	SIZE (Ø cm)
2070419	19
2070421	21
2070424	24
2070427	27
2070430	30
2070433	33
2070436	36

Stainless Steel Tempura Strainer
钢天妇罗隔油网

CODE	SIZE (l x w cm)
A1150601	37.7 x 25.4



Wooden Tempura Chopstick
木天妇罗筷子

CODE	SIZE (l cm)
A1170336	36



“Hsiang” Wooden Chopstick
木筷子

CODE	SIZE (l cm)
A1170231	31
A1170242	42
A1170238	38



Bamboo Chopstick
竹筷子

CODE	SIZE (l cm)
A1170133	33
A1170136	36
A1170139	39



Stainless Steel Deep Noodle Strainer
不锈钢深面厘

CODE	SIZE (Ø cm)
2080214	14



Stainless Steel Steamboat Ladle
火锅勺

CODE	SIZE (Ø cm)
A1150209	9
A1150207	7



Stainless Steel Perforated Steamboat Ladle
有洞褐色柄钢火锅勺

CODE	SIZE (Ø cm)
A1150307	7



Wooden Ramen Spoon / Ladle
木拉面勺(竹手柄)

CODE	SIZE (Ø x l cm)
A1150401	6.5 x 19.0
A1150402	7.5 x 21.5
A1150403	6.5 x 20.0

Black Lacquer Japanese Udon Soup Spoon
黑色日式拉面匙

CODE	SIZE (l x w x h cm)
A1150501	-



Stainless Steel Condiment Container
钢调味料盒

CODE	SIZE (l x w x h cm)	SPEC
2040103	32.0 x 15.5 x 6.3	3 Comp
2040104	41.5 x 15.5 x 6.3	4 Comp
2040105	29.3 x 21.0 x 6.3	5 Comp
2040114	51.4 x 15.5 x 6.3	4 Comp
2040116	29.3 x 31.5 x 6.3	6 Comp

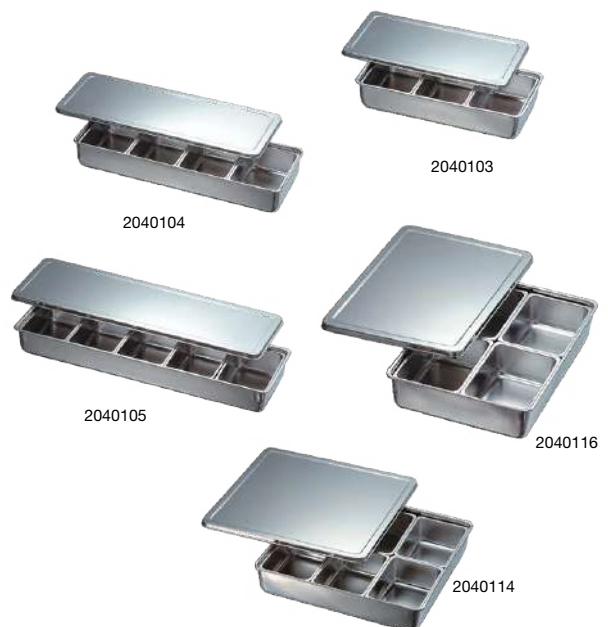



Crab Scissor with Long + Short Edge
钢螃蟹剪刀/长+短边

CODE	SIZE (l cm)
3061221	21



Kitchen Scissor, Heavy Duty
厨房用剪刀

CODE	SIZE (l cm)
3061319	19.5



Kitchen Scissor, Heavy Duty
厨房用剪刀

CODE	SIZE (l cm)
3061523	23



Kitchen Scissor, Heavy Duty
厨房用剪刀

CODE	SIZE (l cm)
3061420	20

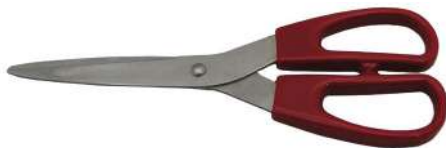

Economy Kitchen Scissor
胶柄厨房用钢剪刀

CODE	SIZE (l cm)
3061721	21.5



Kitchen Scissor with Plastic Handle
胶柄厨房用剪刀

CODE	SIZE (l cm)
3061617	17.0
3061618	18.0
3061619	19.0



Stainless Steel Straight Blade Peeler
直不锈钢刮刨

CODE	SIZE (l cm)
2330405	5



Plastic 'U' Shape Peeler
直不锈钢刮刨

CODE	SIZE (l cm)
2330305	5



Heavy Duty Peeler
不锈钢刮刨

CODE	SIZE (l cm)
2331701	5



Heavy Duty Peeler with Seratted Teeth
不锈钢刮刨

CODE	SIZE (l cm)
2331601	5



Bamboo Pick with Tie end Knot
竹串

CODE	SIZE (l cm)	SPEC
5150601	10 / 8.5	100 Pcs



BAMBOO SPEAR
竹矛

CODE	SIZE (l cm)	SPEC
5050813	9	100 Pcs
5050816	7	100 Pcs
5050817	15	100 Pcs
5050819	24	100 Pcs



Bamboo Flat "Song Ye" Pick
“松叶” 竹针

CODE	SIZE (l cm)	SPEC
5050714	10	100 Pcs
5050715	9	100 Pcs



Flat Bamboo Skewer
‘平’ 竹串

CODE	SIZE (l cm)	SPEC
A1180115	15	100 Pcs
A1180118	18	100 Pcs
A1180121	21	100 Pcs
A1180124	24	100 Pcs



Black Flat Bead Bamboo Pick
黑/红扁珠竹针

CODE	SIZE (l cm)	SPEC
5051310	10.0	100 Pcs
5051312	12.5	100 Pcs
5051315	15.0	100 Pcs

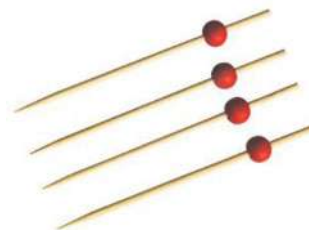

Red Round Bead Bamboo Pick
红中珠竹针

CODE	SIZE (l cm)	SPEC
5051110	10	100 Pcs
5051112	12	100 Pcs
5051115	15	100 Pcs

Disposable Wooden Boat Shape Tray
一次性木皮船

CODE	SIZE (l inch)	SPEC
A1180204	4 / 4.5	100 Pcs
A1180205	5 / 5.5	100 Pcs
A1180206	6 / 6.5	100 Pcs
A1180207	7 / 7.5	100 Pcs
A1180208	8 / 8.5	50 Pcs
A1180209	9 / 9.5	50 Pcs



JAPANESE KITCHEN

Plastic Ice Mould

胶冰模



Square Shape

CODE	SIZE (l x w x h cm)
5150402	-



Boat Shape

CODE	SIZE (l x w x h cm)
5150403	-



Rippled Shape

CODE	SIZE (l x w x h cm)
5150401	-



Leaf Shape

CODE	SIZE (l x w x h cm)
5150404	-



Wooden Bridge 木桥

CODE	SIZE (l x w Inch)
A1050101	17 x 33
A1050102	21 x 50



Wooden Sashimi Boat 木船

CODE	SIZE (l cm)	(Inch)
A1050240	40	16
A1050250	50	20
A1050260	60	24
A1050250	70	28
A1050275	75	30
A1050280	80	32

Sashimi Boat

寿司船



Clear Plastic

CODE	SIZE (l x h cm)
A1050301	35.0 x 7.5
A1050303	53.5 x 9.5



Lacquer Gold

CODE	SIZE (l x h cm)
A1050302	35 x 7.5
A1050304	53.5 x 9.5



Lacquer Gold

CODE	SIZE (l x w x h cm)
A1050401	33 x 17 x 7



Rectangular Rice Box with Cover
有盖长方形饭盒

CODE	SIZE (l x w x h cm)
A1010101	15 x 12 x 5.5



Rectangular Rice Box with Cover
有盖长方形饭盒

CODE	SIZE (l x w x h cm)
A1010102	16.8 14.3 x 7.8



Rectangular Rice Box with Cover
有盖长方形饭盒

CODE	SIZE (l x w x h cm)
A1010103	-



Rectangular Rice Box with Cover
有盖长方形饭盒

CODE	SIZE (l x w x h cm)
A1010104	-



Bento Tray with Red Inner
便当盒/红色

CODE	SIZE (l x w x h cm)
A1010201	-



3-Comp Bento Tray with Black Insert
3格便当盒/黑色

CODE	SIZE (l x w x h cm)
A1010202	-



Long 3-Comp Rectangular Bento Box
3格 长形食物盒/内盒+盖

CODE	SIZE (l x w x h cm)
A1010301	-





Insert only for A1010401
便当盒内盒用于 A1010401

CODE	SIZE (l x w cm)
A1010402	20 x 28.5



Rectangular Bento Box with Insert & Cover
长方形有盖 & 内盒便当盒

CODE	SIZE (l x w cm)
A1010401	21.5 x 30.7 x 6.5



Insert only for A1010501 Box
便当盒内盒用于 A1010501

CODE	SIZE (l x w x h cm)
A1010502	-



Rectangular Bento Box with Cover (No Insert)
长方形有盖便当盒(无内盒)

CODE	SIZE (l x w x h cm)
A1010501	27.3 x 36.2 x 7



Insert only for A1010701
便当盒内盒用于 A1010701

CODE	SIZE (l x w cm)
A1010702	-



Rectangular Bento Box with Insert & Cover
长方形有盖 & 内盒便当盒

CODE	SIZE (l x w x h cm)
A1010701	21.1 x 27.2 x 6.0



Rectangular Bento Box with Insert & Cover
长方形有盖 & 内盒便当盒

CODE	SIZE (l x w x h cm)
A1010601	30.8 x 24.7 x 6.0



Square Bento Box only (No Insert)
方形便当盒外盒(无内盒)

CODE	SIZE (l x w x h cm)
A1010801	26 x 26 x 6



Insert only for A1010801 (Black Inner)
内盒用于 A1010801(黑色)

CODE	SIZE (l x w cm)
A1010802	-



Insert only for A1010801 (Red)
内盒用于 A1010801(红色)

CODE	SPEC
A1010803	Thin Inner
A1010804	Thick Inner



Bento Box with Insert & Cover
长方形有盖 & 内盒便当盒

CODE	SIZE (l x w x h cm)
A1010901	-



Rectangular Bento Box
长方形有盖便当盒

CODE	SIZE (l x w x h cm)
A1010902	-



Rectangular Bento Box with Insert & Cover
长方形有盖 & 内盒便当盒

CODE	SIZE (l x w x h cm)
A1010903	-



Rectangular Bento Box with Cover (No Insert)
长方形有盖便当盒(无内盒)

CODE	SIZE (l x w x h cm)
A1011001	-



6-Comp. Bar Insert for A1011001
6格便当盒内盒用于A1011001

CODE	SIZE (l x w cm)
A1011002	-

JAPANESE KITCHEN



Square Bowl with Red Inner Black Trim
方碗/红色黑边

CODE	SIZE (l x wcm)
A1011101	11.3 x 11.3



Pear Shape Bowl with Red Inner
梨形碗/红色

CODE	SIZE (l x w x h cm)
A1011104	-



Soba Tray with Cup & Bamboo Mat
冷面盘/杯/竹片

CODE	SIZE (l x w x h cm)
A1030101	-



Soba Sauce Cup only for A1030101 (Black)
汤杯用于A1030101(黑色)

CODE	SIZE (l x w x h cm)
A1030103	-



Round Zaru Soba Tray With Bamboo Mat
圆形冷面盘/竹片

CODE	SIZE (Ø cm)
A1030302	23.5



Spare Bamboo Mat for A1030302
竹片用于A1030302盘

CODE	SIZE (Ø cm)
A1030303	19.5



Square Wooden Soba Tray
木冷面盘/架连竹片

CODE	SIZE (l x w cm)
A1030601	21.5 x 21.5 (ID: 17.5 x 17.5)

Ashwood Wooden Service Tray 木托盘

CODE	SIZE (l x w x h cm)
A1020101	55.0 x 35.5 x 6.5
A1020102	32.5 x 32.5 x 5.0
A1020103	19.5 x 32.6 x 4.8



A1020103



A1020102



A1020101

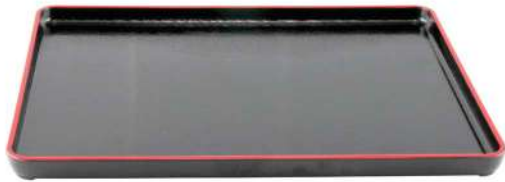

Lacquer Tray 托盘

CODE	SIZE (l x w cm)
A1020201	26.0 x 33.5
A1020202	28.2 x 36.0
A1020203	30.7 x 39.2
A1020204	32.5 x 43.0
A1020205	35.8 x 46.0
A1020206	37.5 x 48.5



Lacquer Tray with Red Slant Rim 托盘

CODE	SIZE (l x w cm)
A1020304	26.4 x 36
A1020305	28.6 x 39
A1020306	30.8 x 42



Lacquer Half Moon Plate 油漆半月盘

CODE	SIZE (Ø Inch)
A1020503	7.5"



Round Black Lacquer Plate 圆形黑漆盘

CODE	SIZE (Ø Inch)
A1020501	7"



Lacquer Tray 油漆托盘

CODE	SIZE (l x w x h Inch)
A1020502	-



Rectangular Lacquer Serving Tray
长形日本餐托盘

CODE	SIZE (l x w cm)
A1020601	20 x 30
A1020602	23 x 33
A1020603	25 x 35
A1020604	28 x 39



Rectangular Lacquer Serving Tray
全黑长形日本餐托盘

CODE	SIZE (l x w cm)
A1020708	24.5 x 38
A1020718	29.5 x 43



Rectangular Lacquer Serving Tray
全黑长形日本餐托盘

CODE	SIZE (l x w cm)
A1020800	25.5 x 35.5
A1020801	27.5 x 38.5
A1020802	29.5 x 42.0
A1020803	29.5 x 41.5



Rectangular Lacquer Serving Tray
全黑长形日本餐托盘

CODE	SIZE (l x w cm)
A1020901	30 x 42



Rectangular Lacquer Tray
长方形托盘/红线边

CODE	SIZE (l x w cm)
A1020902	30 x 42





Cover only for Soba Sauce Cup
盖用于冷面汤杯

CODE	SIZE (l x w x h cm)
A1030402	-



Soba Sauce Cup
冷面汤杯

CODE	SIZE (Ø cm)
A1030401	8.8



Miso Soup Bowl with Cover
有盖味噌汤碗

CODE	SIZE (Ø cm)
A1040102	9.25



Sauce Cup with Cover
有盖酱汁杯

CODE	SIZE (l x w cm)
A1030501	8.2 x 6.5



Flared Miso Soup Bowl with Cover
有盖味噌汤碗

CODE	SIZE (l x w cm)
A1040202	10 x 9.5



Miso Soup Bowl with Cover
有盖味噌汤碗

CODE	SIZE (Ø cm)
A1040101	9.5
A1040103	11



Lacquer Soup Bowl
油漆汤碗

CODE	SIZE (Ø Inch)
A1040204	4.5



Lacquer Miso Soup Bowl with Cover
油漆有盖味噌汤碗(黑色)

CODE	SIZE (Ø cm)
A1040201	9.25

JAPANESE KITCHEN



Soup Bowl
汤碗

CODE	SIZE (Ø x h cm)
A1040206	13 x 6.6



Lacquer Soup Bowl
油漆汤碗

CODE	SIZE (Ø cm)
A1040205	11.2



Lacquer Bowl
油漆碗(红黑)

CODE	SIZE (Ø x h cm)
A1040210	18 x 8



Lacquer Soup Bowl
油漆汤面碗

CODE	SIZE (Ø cm)
A1040207	12.5



Flared Lacquer Bowl
油漆反口碗(红黑)

CODE	SIZE (Ø x h cm)
A1040211	18.4 x 7.9



Lacquer Soup Noodle Bowl
油漆汤面碗

CODE	SIZE (Ø cm)
A1040208	15



Black Rice Bowl with Cover
有盖饭碗(黑色)

CODE	SIZE (l x w x h cm)
A1040213	13.4 x 12.1 x 6



Black Lacquer Rice Bowl with Cover
黑漆有盖饭碗

CODE	SIZE (l x w x h cm)
A1040212	12.3 x 10.9 x 5.1



Round Sushi Tray with Design
圓形寿司盆/圖案

CODE	SIZE (Ø cm)	CODE	SIZE (Ø cm)
A1050601	22.0	A1050606	37.0
A1050602	25.0	A1050607	40.0
A1050603	28.0	A1050608	43.5
A1050604	31.0	A1050609	46.5
A1050605	34.0		



Round Rice Container with Cover
圓形有盖饭盒

CODE	SIZE (Ø cm)
A1050701	16



Square Rice Container with Cover
方形有盖饭盒

CODE	SIZE (l x w x h cm)
A1050702	-



SQ Cotton Face Towel (Extra Thick)
棉毛巾

CODE	SIZE (l x w cm)
7110301	30 x 30



Wooden Towel Tray
木毛巾盘

CODE	SIZE (l x w cm)
A1090901	5.5 x 18.5



Wooden Towel Tray
木毛巾盘

CODE	SIZE (l x w cm)
A1090902	5.5 x 18.0



Black Lacquer Boat Shape Towel Tray
黑漆船形毛巾盘

CODE	SIZE (l x w cm)
A1090903	5.5 x 18.0

JAPANESE KITCHEN



Rectangular Wooden Sushi Tray
长方形寿司盆

CODE	SIZE (l x w x h cm)
A1050801	21 x 12 x 3.8
A1050802	24 x 15 x 3.8
A1050803	27 x 18 x 3.8



Wooden Rectangular Sushi Tray
木长形有脚寿司台

CODE	SIZE (l x w x h cm)
A1051021	21 x 12 x 6
A1051024	24 x 15 x 6
A1051027	27 x 18 x 6



Sushi Handroll Stand
握寿司架

CODE	SIZE (l x w x h cm)	SPEC
A1051105	-	5 Holes
A1051103	-	3 Holes



Wooden Rectangular "Side Aligned" Sushi Tray
木长形有脚寿司台

CODE	SIZE (l x w x h cm)
A1050926	26 x 15 x 6
A1050930	30 x 15 x 6
A1050943	43 x 21 x 6



Green Plastic Decoration Leaf
青色胶装饰叶子

CODE	SIZE (l x w x h cm)
A1051401	-



Bamboo Leaf Shape Plate
竹树叶

CODE	SIZE (l cm)
A1051330	30
A1051340	40



Equipment



FOOD PROCESSORS : CUTTERS & VEGETABLE SLICERS

食物处理器



R 211 XL



R 211 XL Ultra



R 301 Ultra

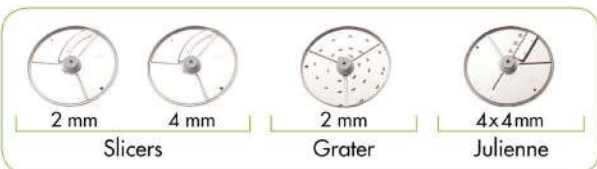

R 211 XL - R 211 XL Ultra

• MOTOR BASE

Induction Motor
Pulse function

• CUTTER FUNCTION

2.9 litre cutter bowl with handle
Smooth blade supplied as standard

• VEGETABLE PREPARATION FUNCTION

XL hopper can hold up to 6 tomatoes in one go
Cylindrical hopper specially designed for long vegetables
Discs not included

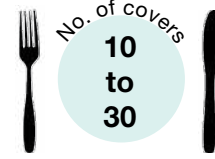

R 211 XL

Code	8010101
Power	550 Watts
Voltage	Single phase 230V/50/1 UK Plug
One speed	1500 rpm
Cutter bowl	composite material
Ejection	continuous
Dimension (l x w x h)	220 x 360 x 445 mm
Gross Weight	9.8 kg

R 211 XL Ultra

Code	8010700
Power	550 Watts
Voltage	Single phase 230V/50/1 UK Plug
One speed	1500 rpm
Cutter bowl	stainless steel
Ejection	continuous
Dimension (l x w x h)	220 x 360 x 445 mm
Gross Weight	12.6 kg

R 301 Ultra

• MOTOR BASE

Induction Motor
Pulse function

• CUTTER FUNCTION

3.7 litre cutter bowl with handle
Smooth blade supplied as standard

• VEGETABLE PREPARATION FUNCTION

Load capacity 1.56 litres
Cylindrical hopper specially designed for long vegetables
Discs not included

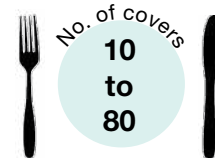

R 301 Ultra

Code	8010103
Power	650 Watts
Voltage	Single phase 230V/50/1 UK Plug
One speed	1500 rpm
Cutter bowl	stainless steel
Dimension (l x w x h)	325 x 300 x 550 mm
Gross Weight	17 kg

Suggested Asian Pack of 4 Discs

Code	1907
-------------	-------------

FOOD PROCESSORS : CUTTERS & VEGETABLE SLICERS
食物处理器

R 401 - R 402

- **MOTOR BASE**
Induction Motor
Metal motor support
Pulse function

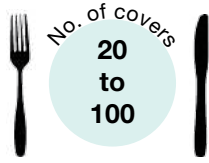

- **CUTTER FUNCTION**
4.5 litre stainless steel bowl with handle
Smooth blade supplied as standard

- **VEGETABLE PREPARATION FUNCTION**
Load capacity 1.56 litres
Cylindrical hopper specially designed for long vegetables
Discs not included



R 401

R 401

Code	8010106
Power	700 Watts
Voltage	Single phase 230V/50/1 UK Plug
One speed	1500 rpm
Dimension (l x w x h)	320 x 304 x 570 mm
Gross Weight	18.5 kg

R 402

Code	8010104
Power	750 Watts
Voltage	Single phase 230V/50/1 UK Plug
Two speed	500 / 1500 rpm
Dimension (l x w x h)	320 x 304 x 590 mm
Gross Weight	20.5 kg



R 402

Suggested Asian Pack of 4 Discs

Code	1907
-------------	-------------

Dicing Equipment for R 402 / CL 40

Code	27113	8 x 8 x 8 mm
Code	27114	10 x 10 x 10 mm
Code	27298	12 x 12 x 12 mm

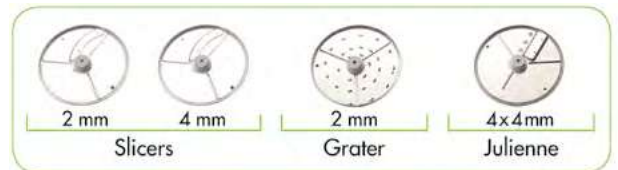

FOOD PROCESSORS : CUTTERS & VEGETABLE SLICERS

食物处理器

R 652 VV

Extra Ergonomic

EXTRA WIDE



Extra-large hopper:
a whole cabbage or
up to 15 tomatoes

**EXTRAORDINARY
USER FRIENDLY**



Power-assisted lever:
less effort for user

EXTRA PRECISE



**Cylindrical hopper
(Ø 58 mm):** a
uniform cut for long
items.

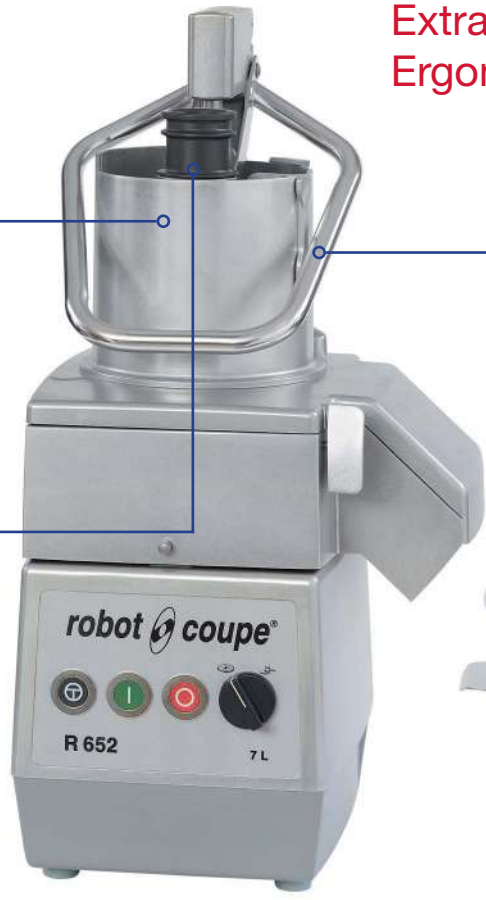

**LATERAL EJECTION
SYSTEM**



- Space-saving
- More convenient

BLADE ASSEMBLY



Supplied with an all
stainless steel, smooth
blade assembly:
2 detachable and
adjustable blades.

LID



Dry or liquid
ingredients can be
added while the
machine is running

R 652 VV

- **MOTOR BASE**
Induction Motor
All metal base
Pulse function

- **CUTTER FUNCTION**
7 litre stainless steel bowl with handle
Smooth blade assembly supplied as standard

- **VEGETABLE PREPARATION FUNCTION**
Load capacity 4.2 litres
Cylindrical hopper specially designed for long vegetables
Discs not included

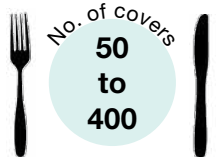

R 652 VV

Code	8010108
Power	1500 Watts
Voltage	Single phase 230V/50-60/1 UK Plug
Variable speed	300 to 3500 rpm in cutter 300 to 1000 rpm in vegetable preparation
R-Mix Function	reverse speed 60 to 500 rpm to mix gently the ingredients
Dimension (l x w x h)	426 x 481 x 880 mm
Gross Weight	33.4 kg

FOOD PROCESSORS : CUTTERS & VEGETABLE SLICERS
食物处理器

R 502 - R 502 VV

• **MOTOR BASE**

Induction Motor
All metal base
Pulse function



• **CUTTER FUNCTION**

5.5 litre stainless steel bowl with handle
Smooth blade supplied as standard

• **VEGETABLE PREPARATION FUNCTION**

Load capacity 2.2 litres
Cylindrical hopper specially designed for long vegetables
Discs not included

R 502

Code	8010105
Power	1000 Watts
Voltage	Three phase 400V/50/3 UK Plug
Two speed	750 / 1500 rpm
Dimension (l x w x h)	380 x 350 x 665 mm
Gross Weight	30 kg



R 502

R 502 VV

Code	8010107
Power	1300 Watts
Voltage	Single phase 230V/50-60/1 UK Plug
Variable speed	300 to 3500 rpm in cutter 300 to 1000 rpm in vegetable preparation
R-Mix Function	reverse speed 60 to 500 rpm to mix gently the ingredients
Dimension (l x w x h)	380 x 350 x 665 mm
Gross Weight	32 kg



R 502 VV

Suggested Pack of 8 Discs

Code	1933
-------------	-------------

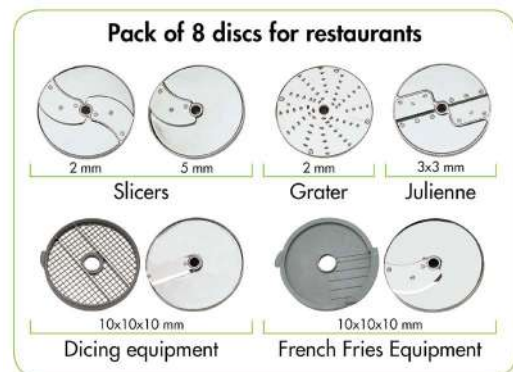

VEGETABLE PREPARATION MACHINES

蔬菜处理器



CL 20



CL 40

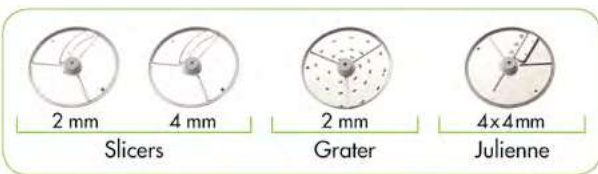

CL 20 - CL 40

• **MOTOR BASE**

Induction Motor

• **VEGETABLE PREPARATION FUNCTION**

Large hopper - Load capacity 1.56 litres

Cylindrical hopper specially designed for long vegetables

Discs not included

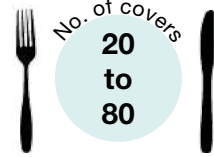

CL 20

Code	8010206
Power	400 Watts
Voltage	Single phase 230V/50/1 UK Plug
One speed	1500 rpm
Dimension (l x w x h)	325 x 304 x 570 mm
Gross Weight	12 kg

CL 40

Code	8010207
Power	500 Watts
Voltage	Single phase 230V/50/1 UK Plug
One speed	500 rpm
Vegetable bowl	stainless steel
Dimension (l x w x h)	320 x 304 x 590 mm
Gross Weight	15.2 kg

Suggested Asian Pack of 4 Discs

Code	1907
-------------	-------------



VEGETABLE PREPARATION MACHINES
蔬菜处理器

CL 50 Gourmet

Code	8010202
Power	550 Watts
Voltage	Single phase 230V/50/1 UK Plug
One speed	375 rpm
Motor	induction
Motor base	stainless steel
Bow & lid	metal
Large hopper	upload capacity 2.1 litres
Cylindrical hopper	Ø 69 mm
Included	2 discs for brunoise or waffle cut
Dimension (l x w x h)	376 x 309 x 581 mm
Gross Weight	22 kg

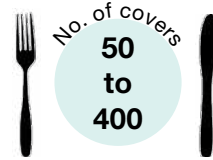

CL 50 Gourmet

Discs

Waffle		Brunoise		1 mm special (Parsley Kit)	
CODE	SIZE	CODE	SIZE	CODE	SIZE
28198	2 mm	28174	2 x 2 x 2 mm	28194	1 mm
28199	3 mm	28175	3 x 3 x 3 mm		
28177	4 mm	28176	4 x 4 x 4 mm		
28178	6 mm				

CL 50

- **MOTOR BASE**
Induction Motor
Motor base polycarbonate

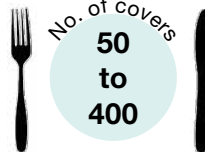

- **VEGETABLE PREPARATION FUNCTION**
Metal vegetable bowl and lid
Large hopper - Load capacity 2.2 litres
Cylindrical hopper specially designed for long vegetables
Discs not included
Mashed potato accessory available as option



CL 50

CL 50

Code	8010201
Power	550 Watts
Voltage	Single phase 230V/50/1 UK Plug
One speed	375 rpm
Dimension (l x w x h)	350 x 320 x 590 mm
Gross Weight	19.8 kg

Suggested Pack of 8 Discs

Code 1933

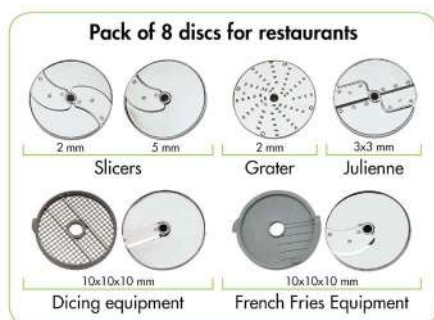

Suggested Asian Pack of 7 Discs

Code 2023

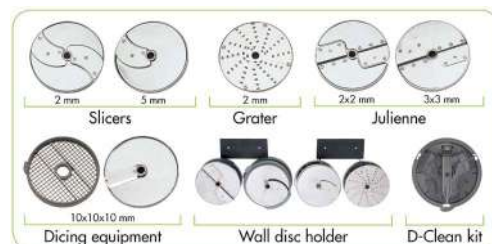

VEGETABLE PREPARATION MACHINES

蔬菜处理器



CL 50 Ultra

CL 50 Ultra

- **MOTOR BASE**
Induction Motor
Polycarbonate motor base



- **VEGETABLE PREPARATION FUNCTION**
Metal vegetable bowl and lid
Large hopper - Load capacity 2.2 litres
Cylindrical hopper specially designed for long vegetables
Discs not included
Mashed potato accessory available as option

CL 50 Ultra

Code	8010208
Power	550 Watts
Voltage	Single phase 230V/50/1 UK Plug
One speed	375 rpm
Dimension (l x w x h)	350 x 320 x 590 mm
Gross Weight	20.2 kg



CL 52

CL 52

- **MOTOR BASE**
Induction Motor
Stainless steel motor base

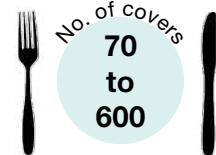

- **VEGETABLE PREPARATION FUNCTION**
Metal vegetable bowl and lid
Large hopper - Load capacity 4.2 litres
Cylindrical hopper specially designed for long vegetables
Discs not included
Mashed potato accessory available as option

CL 52

Code	8010203
Power	750 Watts
Voltage	Single phase 230V/50/1 UK Plug
One speed	375 rpm
Dimension (l x w x h)	360 x 340 x 690 mm
Gross Weight	28 kg

Suggested Pack of 8 Discs

Code	1933
-------------	-------------

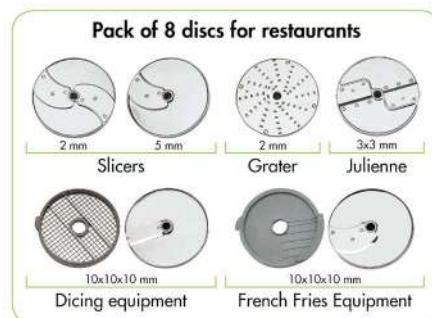

CL 55 WORKSTATION COMPLETE VEG. PREP. SOLUTION

VEGETABLE PREPARATION MACHINES 蔬菜处理器



Up to
1200 kg
of vegetable
per hour

**ADJUSTABLE TROLLEY
3 HEIGHTS**

For the transport and easy loading of vegetables and fruits

Can be used to transport attachment

**AUTOMATIC
FEED HEAD**

For all vegetables in bulk (tomatoes, onions, potatoes..)

**PUSHER
FEED HEAD**

Specially intended for bulky vegetables (e.g. cabbage or celeriac)

**POTATO RICER
EQUIPMENT 3 mm**

Ideal for mashing large amounts of fresh potato.

**ADJUSTABLE TROLLEY
GN 1x1**

3 heights adjustable trolley for transport, loading and reception. delivered with 2 containers GN 1x1

CL 55 Workstation

- MOTOR BASE**
Induction Motor
Stainless steel motor base
- VEGETABLE PREPARATION FUNCTION**
Metal chute and lid
Delivered with:
Automatic feed head
Pusher feed head - capacity 4.9 litres - Tube included
MultiCut pack of 16 discs
Potato ricer equipment 3 mm
All stainless steel mobile stand equipped with wheels and brake
Adjustable Trolley GN 1x1 - 3 heights
3 containers GN 1x1

No. of covers
100 to 1000

CL 55 Workstation

Code	8010209
Power	750 Watts
Voltage	Single phase 230V/50/1
One speed	375 rpm
Dimension (l x w x h)	with stand 865 x 396 x 1272 mm
Gross Weight	53.1 kg

VEGETABLE PREPARATION MACHINES

蔬菜处理器



CL 55 2 Feed-Heads



CL 55 Pusher Feed-Head

CL 55 2 Feed-Heads -
CL 55 Pusher Feed- Head

- **MOTOR BASE**
Induction Motor
All-metal motor base



- **VEGETABLE PREPARATION FUNCTION**
Metal chute and lid
All stainless steel mobile stand equipped with wheels and brake included
Discs not included
Mashed potato accessory available as option

CL 55 2 Feed-Heads large output

Code	8010204
Power	750 Watts
Voltage	Single phase 230V/50/1
One speed	375 rpm
Automatic feed head	stainless steel
Pusher feed head	metal - load capacity 4.2 litres - Tube included
Dimension (l x w x h)	with stand 865 x 396 x 1272 mm
Gross Weight	51.3 kg

CL 55 Pusher Feed-Head

Code	8010210
Power	750 Watts
Voltage	Single phase 230V/50/1
One speed	375 rpm
Automatic feed head	stainless steel
Pusher feed head	metal - load capacity 4.2 litres - Tube included
Dimension (l x w x h)	with stand 865 x 396 x 1272 mm
Gross Weight	43.6 kg

Suggested Pack of 8 Discs

Code	1933
-------------	-------------

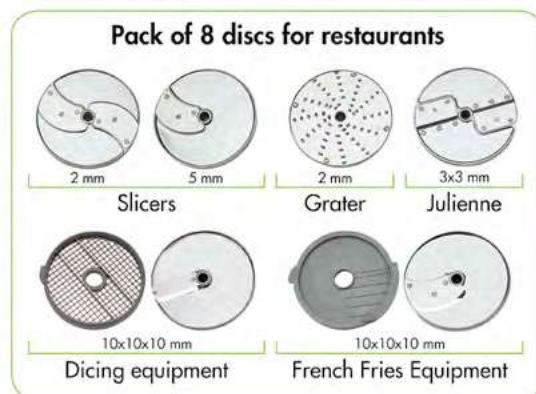

VEGETABLE PREPARATION MACHINES
蔬菜处理器

CL 60 WORKSTATION
COMPLETE VEG. PREP. SOLUTION



Up to
1800 kg
of vegetable
per hour

WORKSTATION STORAGE TROLLEY

- Place all accessories on the trolley!
- Tray for 16 discs and 8 attachments
- Container GN 1x1 for kitchenware
- 3 chutes
 - Pusher Feed Head
 - 4 Tubes Feed Head
 - Automatic Feed Head

ADJUSTABLE FOOT
Machine stable on the floors

AUTOMATIC FEED HEAD

For all vegetables in bulk (tomatoes, onions, potatoes..)

PUSHER FEED HEAD

Specially intended for bulky vegetables (e.g. cabbage or celeriac)

4 TUBES FEED HEAD

Specially intended for long vegetables, like cucumbers, or zucchini

POTATO RICER EQUIPMENT 3mm

Ideal for mashing large amounts of fresh potato

ERGO MOBILE TROLLEY

Can accommodate three full-size gastronorm pans

• MOTOR BASE
Induction Motor
Stainless steel motor base

• VEGETABLE PREPARATION FUNCTION
Equipped with:

- one adjustable foot: machine stable on all floor
- 2 wheels
- Stainless steel tray for tools

Delivered with:

- Pusher feed head 238 cm² - capacity 4.2 litres
- + Automatic feed haed
- + Tube included 58 mm
- + 4 tunes feed head
- + Ergo mobile trolley
- + Three full-size gastronorm pans
- + Mashed potato equipment 3 mm
- + MultiCut pack of 16 discs
- + Storage Trolley

No. of covers
300 to 3000

CL 60 Workstation

Code	8010205
Power	1500 Watts
Voltage	Three phase 400V/50/3
Speed	375 & 750 rpm
Dimension (l x w x h)	462 x 770 x 1353 mm
Gross Weight	74 kg

CL 60 2 Feed-Head * Trolley not included

Code	8010211
Dimension (l x w x h)	600 x 720 x 1225 mm
Gross Weight	91.5 kg

CL 60 Pusher Feed-Head * Trolley not included

Code	8010212
Dimension (l x w x h)	425 x 613 x 1159 mm
Gross Weight	70 kg

TABLE TOP CUTTER MIXERS

台式电搅碎机



R 2

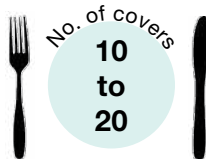

R 2 - R 3 -1500

- **MOTOR BASE**
Induction Motor
Polycarbonate motor base
- **CUTTER FUNCTION**
Metal vegetable bowl and lid
Large hopper - Load capacity 2.2 litres
Cylindrical hopper specially designed for long vegetables
Discs not included
Mashed potato accessory available as option

R 2

Code	8010301
Power	550 Watts
Voltage	Single phase 230V/50/1 UK Plug
One speed	1500 rpm
Stainless Steel Bowl	2.9 litre
Function	pulse
Dimension (l x w x h)	200 x 280 x 350 mm
Gross Weight	10.5 kg



R 3

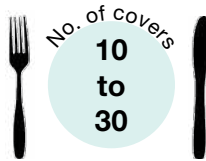

R 3 - 1500

Code	8010302
Power	650 Watts
Voltage	Single phase 230V/50/1 UK Plug
One speed	1500 rpm
Stainless Steel Bowl	3.7 litre
Function	pulse
Dimension (l x w x h)	210 x 320 x 400 mm
Gross Weight	11.2 kg



R 6

R 6

- **MOTOR BASE**
Induction Motor
All metal motor base
Pulse function
- **CUTTER FUNCTION**
7 litre stainless steel bowl with handle
Stainless steel smooth blade assembly supplied as standard

R 6

Code	8010306
Power	1300 Watts
Voltage	Three phase 400V/50/3
Two speed	1500 / 3000 rpm
Dimension (l x w x h)	280 x 350 x 520 mm
Gross Weight	24.8 kg

TABLE TOP CUTTER MIXERS
台式电搅碎机

Transparent lid allows observation of the contents being processed and greater control. Dishwasher safe



Optional coarse serrated blade for grinding and kneading.

Liquids or ingredients can be easily added during processing



Brushed stainless steel bowl with handles



Optional fine serrated blade cutting parsley and spices.

High bowl shaft allows for greater liquid volume processing



New profile patented blades for an optimal cut quality and absolute consistency



R 10

R 10

- **MOTOR BASE**
Induction Motor
Pulse function



No. of covers
50 to 200



- **CUTTER FUNCTION**
Stainless steel 11.5 litre with 2 handles
3 Stainless steel smooth blade assembly supplied as standard
4-litre Mini bowl available as an optional extra

R 10

Code	8010304
Power	2600 Watts
Voltage	Three phase 400V/50/3
Two speed	1500 / 3000 rpm
Dimension (l x w x h)	345 x 560 x 660 mm
Gross Weight	49.7 kg

R 8

- **MOTOR BASE**
Induction Motor
Pulse function



No. of covers
20 to 150



- **CUTTER FUNCTION**
Stainless steel 8 litre with 2 handles
2 Stainless steel smooth blade assembly supplied as standard
3.5-litre Mini bowl available as an optional extra

R 8

Code	8010307
Power	2200 Watts
Voltage	Three phase 400V/50/3
Two speed	1500 / 3000 rpm
Dimension (l x w x h)	315 x 545 x 585 mm
Gross Weight	44.9 kg



R 8

VERTICAL CUTTER MIXERS

电搅碎机



Transparent lid for perfect control of the process. Ergonomic locking device of the lid bowl. **Lid and seal designed** to be removed simply and quickly for perfect cleaning



Lid wiper to wipe the inside of the lid, ensuring perfect visibility during processing



Control panel
Build in stainless steel control buttons, 0-15 minute **timer** and Pulse control for greater cutting precision



Tilting Mecanism
Ergonomic lever enabling the user to tilt the bowl at various angles.



Blade
New patented blade profile for an optimum cutting quality.

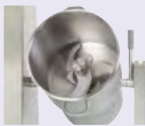

Bowl
Tilting and removable bowl, a Robot Coupe exclusivity.
Capacity: 23, 28, 45 or 60 litre according the model



Flame
100% stainless steel, Perfect stability on the floor, Compact and easy cleaning.



3 retractable wheels included
To make moving the appliance in the kitchen easier
Easy cleaning of the surface underneath the appliance

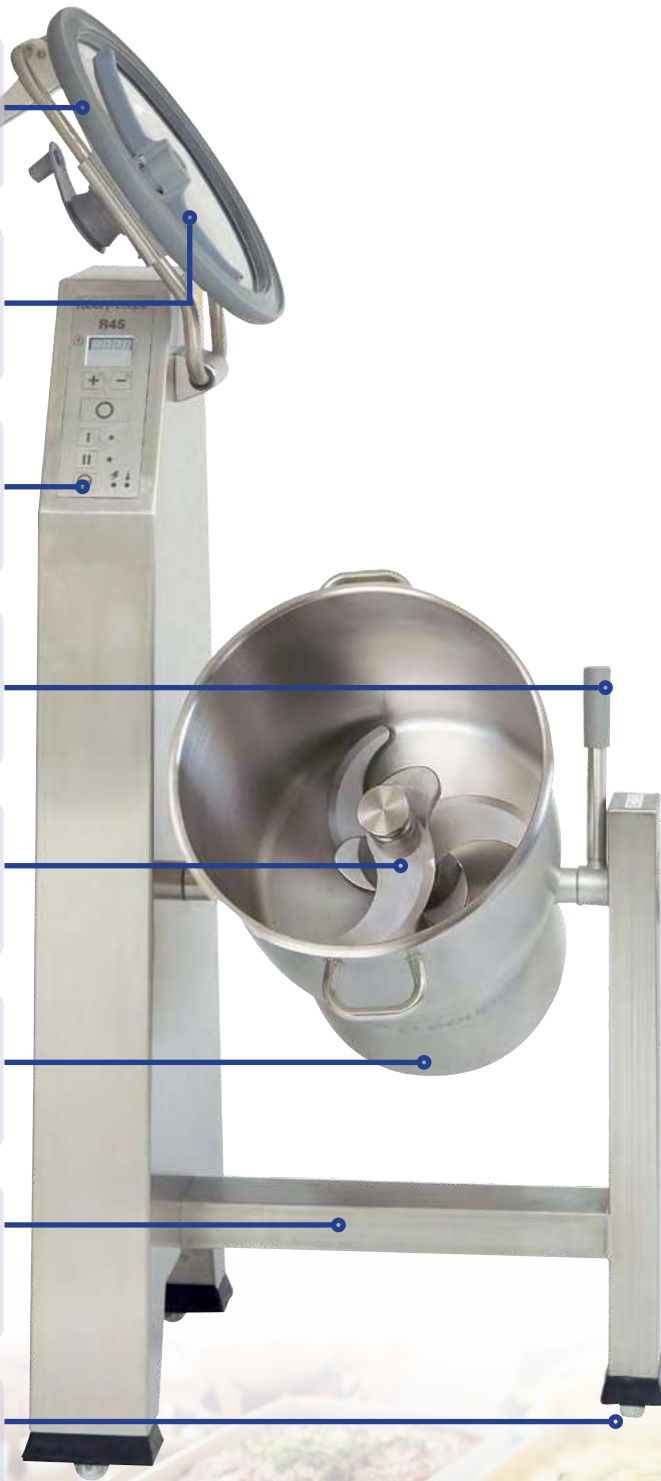

VERTICAL CUTTER MIXERS

机

R 30 - R 45

• **MOTOR BASE**

All stainless steel machine
Pulse function

• **CUTTER FUNCTION**

Stainless steel bowl with 2 handles
IP65 control panel equipped with a digital minute timer
Delivered with :
Transparent polycarbonate lid
+ 3 smooth blade assembly
+ Lid wiper
+ Set of 3 retractable wheels

R 30

Code	8010305
Power	5400 Watts
Voltage	Three phase 400V/50/3
Two speed	1500 / 3000 rpm
Dimension (l x w x h)	720 x 600 x 1250 mm
Gross Weight	148.4 kg

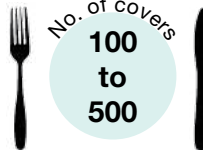

R 30

R 45

Code	8010308
Power	10000 Watts
Voltage	Three phase 400V/50/3
Two speed	1500 / 3000 rpm
Dimension (l x w x h)	720 x 600 x 1400 mm
Gross Weight	194.8 kg

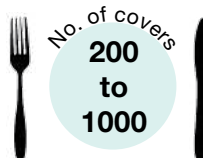

R 45



Robot Cook®

COOKING CUTTER BLENDER

The 1st Professional Cooking Cutter Blender !

Robot Cook®

Code	8010309
Power	1800 Watts
Voltage	Single phase 230V/50/1
Induction	motor
5 Speed functions:	
• Variable speed	from 100 to 3500 rpm
• High speed	Turbo/Pulse of 4500 rpm
• R-Mix blend speed	from -100 to -500 rpm
• Pulse	Variable speed
• Intermittent speed	slow speed blade rotation every 2 seconds
Heating capacity	up to 140°C
Precise temperature control	+ or - 1°C
Stainless steel bowl cutter	3.7 litres with handle
Liquid capacity	2.5 litres
Blade	micro-serrated stainless steel
Scraper arm	lid and bowl
Programming function	9 recipes
Dimension (l x w x h)	226 x 338 x 522 mm
Gross Weight	15 kg



The Kitchen Assistant for Chefs

Emulsifying, grinding, mixing, chopping, blending and keanding are among the many functions carried out to perfection by the Robot Cook®. In addition, there is moduable heating capacity up to 140°C, accurate to the nearest degree. The large capacity bowl means you can produce sufficient quantities for professional needs.

The Robot Cook® stimulates the imagination of chefs. It is the ideal assistant when innovating and preparing a multitude of attractive, hot and cold, savoury or sweet recipes.



A meticulous assistant

- Easy to use with its variable speed function of 100 to 3,500 rpm.
- Refined dishes prepared in no time with its Turbo /Pulse rotary speed reaching 4,500 rpm per minute.
- Optimum control of food preparations possible with the high precision Pulse function.
- A mix of delicate products prepared without cutting due to the inverse rotation of the blade: the R-Mix® function
- Keeps the food preparation hot thanks to the intermittent function.



An autonomous assistant

Using the programming function, entrust your secret preparations to Robot Cook® and effortlessly reproduce your favourite recipes.

A dependable assistant

The powerful Robot Cook® relies on a very robust industrial induction motor.



A silent assistant

In the hive of kitchen activity, the chefs will appreciate its silence.



3,7 L
> 140°C
to the nearest degree
4500 rpm

BLIXER®
电搅碎机



Blixer 2



Blixer 3



Blixer 4



Blixer 4 V.V

Blixer 2 - Blixer 3

- **MOTOR BASE**
Induction motor
Stainless steel motor shaft
Pulse function
- **BLIXER FUNCTION**
Fine-serrated blade assembly supplied as standard
Stainless steel bowl with handle
Tight sealing lid and a bowl and lid scraper

Blixer 2

Code	8010401
Power	700 Watts
Voltage	Single phase 230V/50/1 UK Plug
One speed	3000 rpm
Bowl	2.9 L
Dimension (l x w x h)	210 x 281 x 389 mm
Gross Weight	11.5 kg

Blixer 3

Code	8010402
Power	750 Watts
Voltage	Single phase 230V/50/1 UK Plug
One speed	3000 rpm
Bowl	3.7 L
Dimension (l x w x h)	242 x 304 x 444 mm
Gross Weight	13.2 kg

Blixer 4 - Blixer 4 VV

- **MOTOR BASE**
Induction motor
All metal motor shaft
Pulse function
- **BLIXER FUNCTION**
Fine-serrated blade assembly supplied as standard
Stainless steel 4.5 litre bowl with handle
Tight sealing lid and a bowl and lid scraper

Blixer 4

Code	8010403
Power	900 Watts
Voltage	Single phase 230V/50/1 UK Plug
Bowl	4.5 L
Two speeds	1500 & 3000 rpm
Dimension (l x w x h)	242 x 304 x 444 mm
Gross Weight	14.8 kg

Blixer 4 V.V

Code	8010408
Power	1100 Watts
Voltage	Single phase 230V/50-60/1
Bowl	4.5 L
Variable speed	300 to 3500 rpm
Dimension (l x w x h)	242 x 332 x 479 mm
Gross Weight	17.3 kg

Blixer 5 Plus - Blixer 5 V.V

- MOTOR BASE**
 Induction motor
 Stainless steel motor shaft
 All metal motor base
 Pulse function
- BLIXER FUNCTION**
 Fine-serrated blade assembly supplied as standard
 Stainless steel 5.5 litre bowl with handle
 Tigh sealing lid and a bowl and lid scraper

Blixer 5 Plus

Code	8010405
Power	1300 Watts
Voltage	Three phase 400V/50/3
Two speeds	1500 and 3000 rpm
Bowl	5.5 litre
Dimension (l x w x h)	280 x 350 x 500 mm
Gross Weight	24 kg

Blixer 5 V.V

Code	8010409
Power	1400 Watts
Voltage	Single phase 230V/50-60/1 UK Plug
Variable speed	300 to 3500 rpm
Bowl	5.5 litre
Dimension (l x w x h)	280 x 350 x 500 mm
Gross Weight	25 kg



Blixer 5 Plus



Blixer 5 V.V

Blixer 6 - Blixer 6 V.V

- MOTOR BASE**
 Induction motor
 Stainless steel motor shaft
 All metal motor base
 Pulse function
- BLIXER FUNCTION**
 Fine-serrated blade assembly supplied as standard
 Stainless steel 7 litre bowl with handle
 Tigh sealing lid and a bowl and lid scraper

Blixer 6

Code	8010406
Power	1300 Watts
Voltage	Three phase 400V/50/3
Two speeds	1500 and 3000 rpm
Bowl	7 litre
Dimension (l x w x h)	280 x 350 x 535 mm
Gross Weight	25.6 kg

Blixer 6 V.V

Code	8010407
Power	1500 Watts
Voltage	Single phase 230V/50-60/1 UK Plug
Variable speed	300 to 3500 rpm
Bowl	7 litre
Dimension (l x w x h)	280 x 350 x 535 mm
Gross Weight	26.3 kg



Blixer 6



Blixer 6 V.V

BLIXER®
电搅碎机



Blixer 10

Blixer 10 - Blixer 10 V.V

• **MOTOR BASE**

Induction motor
Pulse function

• **BLIXER FUNCTION**

Stainless steel 11.5 litre bowl with handle
Transparent and sealed lid
Fine-serrated 3 stainless steel blade assembly supplied as standard
tight sealing lid and a bowl and lid scraper

Blixer 10

Code	8010410
Power	2600 Watts
Voltage	Three phase 400V/50/3
Two speeds	1500 and 3000 rpm
Dimension (l x w x h)	315 x 545 x 680 mm
Gross Weight	50.6 kg



Blixer 10 V.V

Blixer 10 V.V

Code	8010411
Power	2600 Watts
Voltage	Single phase 200-240V/50-60/1
Variable speed	300 to 3500 rpm
Dimension (l x w x h)	315 x 545 x 680 mm
Gross Weight	51.4 kg



Blixer 30 - Blixer 60

- **MOTOR BASE**
All stainless steel casing
- **BLIXER FUNCTION**
IP65 control panel equipped with a digital minute timer
Transparent polycarbonate lid
Fine-serrated 2 stainless steel blade assembly supplied as standard
Scraper arm and lid wiper
3 retractable wheels

Blixer 30

Code	8010412
Power	5400 Watts
Voltage	Three phase 400V/50/3
Two speeds	1500 and 3000 rpm
Stainless steel bowl	28 litre with handle
Dimension (l x w x h)	720 x 600 x 1250 mm
Gross Weight	148.4 kg

Blixer 60

Code	8010413
Power	11000 Watts
Voltage	Three phase 400V/50/3
Two speeds	1500 and 3000 rpm
Stainless steel bowl	60 litre with handle
Dimension (l x w x h)	810 x 600 x 1400 mm
Gross Weight	209.6 kg



Blixer 30













Blixer 60



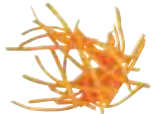





DISCS COLLECTION

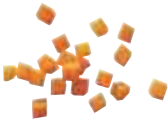

	 Ø 175 mm	 Ø 175 mm	 Ø 190 mm	 Ø 190 mm		
	R 201 XL R 201 XL Ultra R 211 XL R 211 XL Ultra R 301 R 301 Ultra / R 401 CL 20	R 402 R 402 V.V. CL 40	DISCS		R 502/R 502 V.V. R 652/R 652 V.V. CL 50/CL 50 Ultra CL 52/CL 55/CL 60	CL 50 Gourmet Parsley kit
SLICERS						
			Almonds 0.6 mm	28166	28166	
			0.8 mm	28069	28069	
27051		27051	1 mm	28062	28062	
27555		27555	2 mm	28063	28063	
27086		27086	3 mm	28064	28064	
27566		27566	4 mm	28004	28004	
27087		27087	5 mm	28065	28065	
27786		27786	6 mm	28196	28196	
			8 mm	28066	28066	
			10 mm	28067	28067	
			14 mm	28068	28068	
			4 mm for cooked potatoes	27244	27244	
			6 mm for cooked potatoes	27245	27245	
 RIPPLE CUT SLICERS	27621	27621	2 mm	27068	27068	
			3 mm	27069	27069	
			5 mm	27070	27070	
GRATERS	27588	27588	27148	1.5 mm	28056	28056
	27577	27577	27149	2 mm	28057	28057
	27511	27511	27150	3 mm	28058	28058
				4 mm	28073	28073
				5 mm	28059	28059
27046		27046		6 mm		
				7 mm	28016	28016
27632		27632		9 mm	28060	28060
27764		27764		Parmesan	28061	28061
27191		27191		Röstis potatoes	27164	27164
				Raw potatoes	27219	27219
	27078	27078		0.7 mm for horseradish paste		
	27079	27079		1 mm for horseradish paste	28055	28055
	27130	27130		1.3 mm for horseradish paste		
JULIENNE				1 x 8 mm	28172	28172
				1 x 30 onions/Cabbage	28153	28153
27080		27080		2 x 4 mm	27072	27072
27081		27081		2 x 6 mm	27066	27066
				2 x 8 mm	27067	27067
				2 x 10 mm	28173	28173
	27599	27599		2 x 2 mm	28051	28051
				2.5 x 2.5 mm	28195	28195
				3 x 3 mm	28101	28101
	27047	27047		4 x 4 mm	28052	28052
	27610	27610		6 x 6 mm	28053	28053
	27048	27048		8 x 8 mm	28054	28054

DISCS COLLECTION





	 Ø 175 mm R 402 R 402 V.V. CL 40	DISCS	 Ø 190 mm R 502/R 502 V.V. R 652/R 652 V.V. CL 50/CL 50 Ultra CL 52/CL 55/CL 60	 Ø 190 mm CL 50 Gourmet Parsley kit
DICING EQUIPMENT  1 DICING GRID + 1 SLICER	■ 27113	5 x 5 x 5 mm	■ 28110	■ 28110
	■ 27114	8 x 8 x 8 mm	■ 28111	■ 28111
	■ 27298	10 x 10 x 10 mm	■ 28112	■ 28112
		12 x 12 x 12 mm	■ 28197	■ 28197
		14 x 14 x 5 mm (mozzarella)	■ 28181	■ 28181
		14 x 14 x 10 mm	■ 28179	■ 28179
		14 x 14 x 14 mm	■ 28113	
		20 x 20 x 20 mm	■ 28114	
FRENCH FRIES EQUIPMENT 	▲ 27116	8 x 8 mm	▲ 28134	▲ 28134
	▲ 27117	8 x 16 mm	▲ 28159	▲ 28159
		10 x 10 mm	▲ 28135	▲ 28135
		10 x 16 mm	▲ 28158	▲ 28158
BRUNOISES 		2 x 2 x 2 mm		28174
		3 x 3 x 3 mm		28175
		4 x 4 x 4 mm		28176
WAFFLE 		2 mm		28198
		3 mm		28199
		4 mm		28177
		6 mm		28178

RAPPEL



- Dicing equipment delivered with : 1 dicing grid + 1 slicing disc.
- ▲ French Fries equipment delivered with: 1 French Fries grid + 1 slicing disc.

ACCESSORIES		Ref.
WALL-MOUNTED DISC HOLDER For CL50 To store 6 discs		101230
D-CLEAN KIT : CLEANING TOOL DICING GRIDS		39881
DISC PROTECTOR For R502 to R652 VV discs CL50 to CL60 VV discs		39726

POWER MIXERS

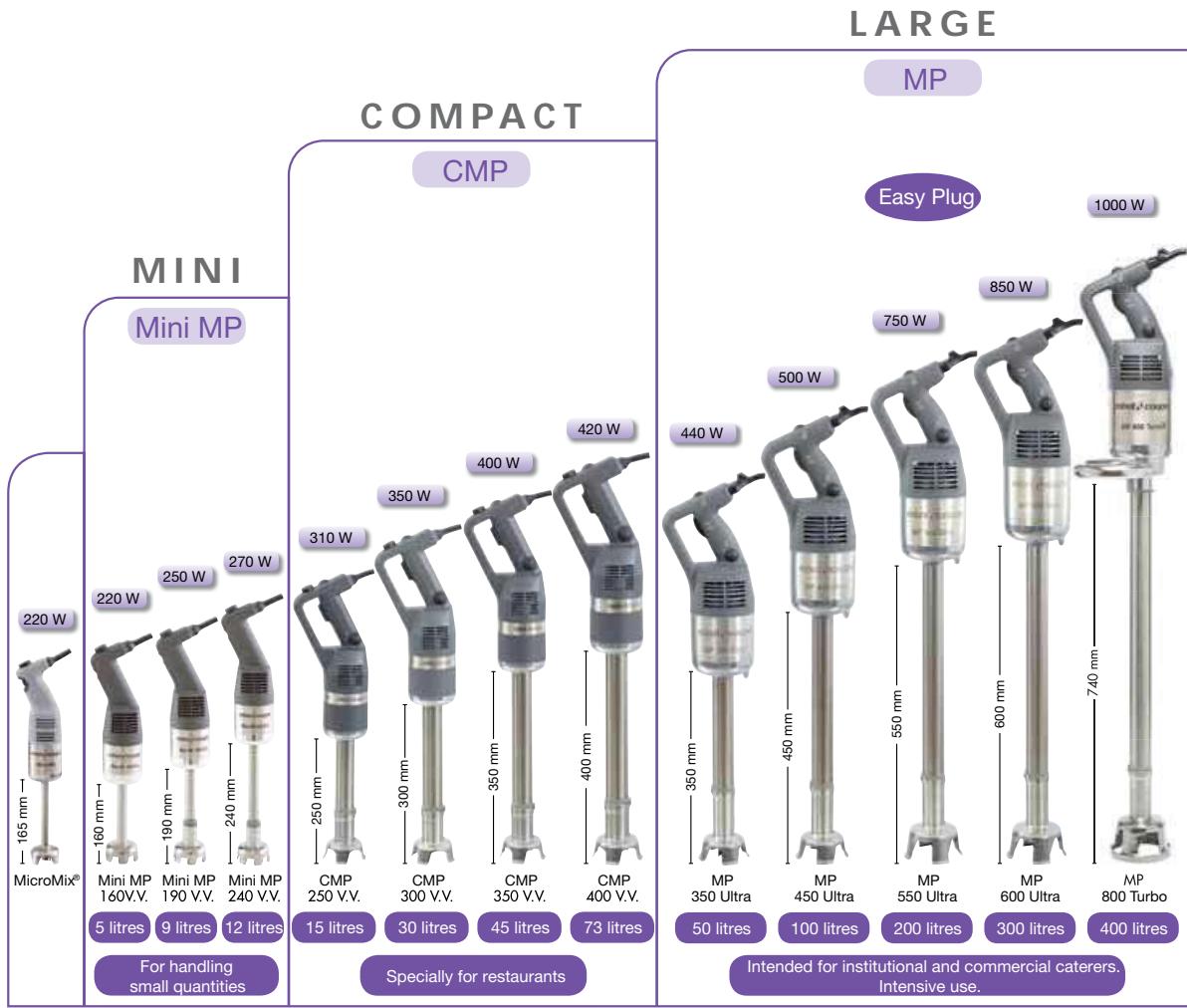

- ▶ Special for emulsions
- ▶ For handling small quantities
- ▶ Specially for restaurants Up to 45 litres
- ▶ Intended for institutional and commercial caterers. Intensive use.

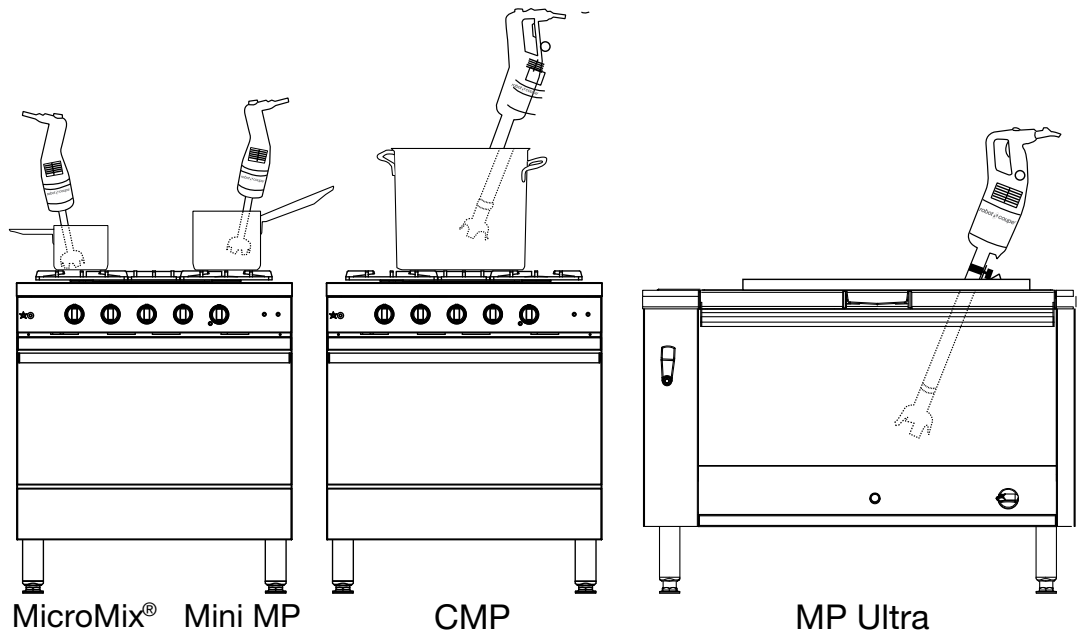

POWER MIXERS



COMBI

Mini MP - CMP - MP Ultra - MP FW Ultra

Model	Power (W)	Capacity (litres)	Height (mm)	Accessories (mm)
Mini MP 190 Combi	250 W	9 litres	190 mm	-
Mini MP 240 Combi	270 W	12 litres	240 mm	185 mm
CMP 250 Combi	310 W	15 litres	250 mm	220 mm
CMP 300 Combi	350 W	30 litres	300 mm	-
MP 350 Combi Ultra	440 W	50 litres	350 mm	280 mm
MP 450 Combi Ultra	500 W	100 litres	450 mm	-
MP 450 FW Ultra	500 W	100 litres	-	-

For handling small quantities

CLEANING

Blade and bell easily removable

With in the HACCP procedure, we advise users to stock the bell and the knife in cold room after cleaning.



USER COMFORT

Pan supports easy to use for easy process

1 stainless steel adjustable pan supports

- Diameter of the pan : 330 mm to 650 mm
- Diameter of the pan : 500 mm to 1000 mm
- Diameter of the pan : 850 mm to 1300 mm

2 stainless steel universal pan support to fix on the edge of the pan

POWER MIXERS



MicroMix®

The Chefs' Top Choice. A perfect emulsion within seconds.

PERFORMANCE

New bell design for even speedier performance. A powerful and ultra-quiet appliance.

STURDINESS

100% stainless-steel tube, bell, motor unit and tools.

ERGONOMIC

Accurate and conveniently placed speed adjustment knob. Extendable coiled power cord for easier handling.

HYGIENE

The tube and tools can be detached for easy cleaning. Practical storage solution for both mixer and tools.



AEROMIX

Patented



Patented tool specially designed to produce instant light and airy emulsions that hold their shape.



KNIFE

For making small portions of all your favourite soups and sauces.

MicroMix®

Code	8022001
Power	220 Watts
Voltage	Single phase 230V/50/1
Variable speed	1500 to 14000 rpm
Blade, Aeromix and tube	100% stainless steel, total length 165 mm
Aeromix and stainless steel blade	detachable
Delivered with	1 stainless steel wall support
Dimension (l x w x h)	Total length 430 mm, Ø 61 mm
Gross Weight	1.4 kg



POWER MIXERS
电动搅拌机

Mini MP 160 V.V - Mini MP 190 V.V - Mini MP 240 V.V

All stainless steel knife, bell disc and tube
Delivered with 1 stainless steel wall support

Mini MP 160 V.V

Code	8020516
Power	220 Watts
Voltage	Single phase 240V/50/1 UK Plug
Variable speed	2000 to 12500 rpm
Tube length	160 mm
Dimension (l x w x h)	Total length 430 mm, Ø 78 mm
Gross Weight	2.4 kg

Mini MP 190 V.V

Code	8020519
Power	250 Watts
Voltage	Single phase 240V/50/1 UK Plug
Variable speed	2000 to 12500 rpm
Tube length	190 mm
Foot with removable bell	a Robot Coupe exclusive patented system
Dimension (l x w x h)	Total length 470 mm, Ø 78 mm
Gross Weight	2.5 kg

Mini MP 240 V.V

Code	8020524
Power	270 Watts
Voltage	Single phase 240V/50/1 UK Plug
Variable speed	2000 to 12500 rpm
Tube length	240 mm
Foot with removable bell	a Robot Coupe exclusive patented system
Dimension (l x w x h)	Total length 520 mm, Ø 78 mm
Gross Weight	2.5 kg



Mini MP 160 V.V

Mini MP 190 V.V

Mini MP 240 V.V

CMP 300 V.V - CMP 350 V.V

Self regulating speed system
Patented removable foot and blade
A Robot Coupe exclusive patented system
Delivered with 1 stainless steel wall support

CMP 300 V.V

Code	8020103
Power	350 Watts
Voltage	Single phase 240V/50/1 UK Plug
Variable speed	2300 to 9600 rpm
Tube length	300 mm
Dimension (l x w x h)	Total length 660 mm, Ø 94 mm
Gross Weight	3.9 kg

CMP 350 V.V

Code	8020105
Power	400 Watts
Voltage	Single phase 240V/50/1 UK Plug
Variable speed	2300 to 9600 rpm
Tube length	350 mm
Dimension (l x w x h)	Total length 718 mm, Ø 94 mm
Gross Weight	4.1 kg



CMP 300 V.V

CMP 350 V.V

POWER MIXERS
电动搅拌机



MP 350 Ultra



MP 450 Ultra



MP 550 Ultra



MP 600 Ultra



MP 800 Turbo

MP 350 Ultra - MP 450 Ultra

Removable foot and blade, a Robot Coupe exclusive patented system
Delivered with 1 stainless steel wall support

MP 350 Ultra

Code	8020305
Power	440 Watts
Voltage	Single phase 230V/50/1 UK Plug
One speed	9500 rpm
Tube length	350 mm
Dimension (l x w x h)	Total length 725 mm, Ø 125 mm
Gross Weight	6.2 kg

MP 450 Ultra

Code	8020310
Power	500 Watts
Voltage	Single phase 230V/50/1 UK Plug
One speed	9500 rpm
Tube length	450 mm
Dimension (l x w x h)	Total length 825 mm, Ø 125 mm
Gross Weight	6.3 kg

MP 550 Ultra - MP 600 Ultra - MP 800 Turbo

Removable foot and blade, a Robot Coupe exclusive patented system
Delivered with 1 stainless steel wall support
We recommend using these models with a pan support

MP 550 Ultra

Code	8020320
Power	750 Watts
Voltage	Single phase 230V/50/1 UK Plug
One speed	9000 rpm
Tube length	550 mm
Dimension (l x w x h)	Total length 925 mm, Ø 125 mm
Gross Weight	6.6 kg

MP 600 Ultra

Code	8020330
Power	850 Watts
Voltage	Single phase 230V/50/1 UK Plug
One speed	9500 rpm
Tube length	600 mm
Dimension (l x w x h)	Total length 970 mm, Ø 125 mm
Gross Weight	7.4 kg

MP 800 Turbo

Code	8020350
Power	1000 Watts
Voltage	Single phase 230V/50/1 UK Plug
One speed	9500 rpm
Tube length	740 mm
Ergonomic double	handle design making it more comfortable to use
New	Electric Booster System technology
Dimension (l x w x h)	Total length 1130 mm, Ø 125 mm
Gross Weight	9.2 kg

POWER MIXERS
电动搅拌器

Mini MP 190 Combi - Mini MP 240 Combi
CMP 300 Combi

Self regulating speed system
Delivered with 1 stainless steel wall support

Mini MP 190 Combi

Code	8020619
Power	250 Watts
Voltage	Single phase 230V/50/1 UK Plug
Variable speed	from 2000 to 12500 rpm in mixer function from 350 to 1500 rpm in whisk function
Tube length	190 mm
Dimension (l x w x h)	Length with tube: 470 mm Length with whisk 535 mm Ø78 mm
Gross Weight	2.7 kg

Mini MP 240 Combi

Code	8020624
Power	270 Watts
Voltage	Single phase 230V/50/1 UK Plug
Variable speed	from 2000 to 12500 rpm in mixer function from 350 to 1500 rpm in whisk function
Tube length	240 mm
Dimension (l x w x h)	Length with tube: 535 mm Length with whisk 535 mm Ø78 mm
Gross Weight	2.8 kg

CMP 300 Combi

Code	8020203
Power	300 Watts
Voltage	Single phase 230V/50/1 UK Plug
Variable speed	from 2300 to 9600 rpm in mixer function from 500 to 1800 rpm in whisk function
Tube length	300 mm
Gear box	metal
Foot	equipped with a 3 level watertight system
Dimension (l x w x h)	Length with tube 700 mm Length with whisk 730 mm Ø125 mm
Gross Weight	5.7 kg



Mini MP 190 Combi



Mini MP 240 Combi



CMP 300 Combi



POWER MIXERS

电动搅拌器

MP 350 Combi Ultra - MP 450 Combi Ultra

Self regulating speed system
 All stainless steel removable knife, bell, whisk and tube, a Robot Coupe exclusive patented system
 New metal gearbox even more resistant when processing pancakes or fresh mashed potatoes
 Delivered with 1 stainless steel wall support

MP 350 Combi Ultra



MP 350 Combi Ultra

Code	8020405
Power	440 Watts
Voltage	Single phase 230V/50/1 UK Plug
Variable speed	from 1500 to 9000 rpm in mixer function from 250 to 1500 rpm in whisk function
Tube length	350 mm
Dimension (l x w x h)	Length with tube: 725 mm Length with whisk 805 mm Ø125 mm
Gross Weight	7.9 kg

MP 450 Combi Ultra

Code	8020410
Power	500 Watts
Voltage	Single phase 230V/50/1 UK Plug
Variable speed	from 1500 to 9000 rpm in mixer function from 250 to 1500 rpm in whisk function
Tube length	450 mm
Dimension (l x w x h)	Length with tube: 890 mm Length with whisk 805 mm Ø125 mm
Gross Weight	8.2 kg



MP 450 Combi Ultra



Adjustable Support Accessory

可调动配件



CODE	SIZE (Ø cm)
8020700	33 - 65

- All stainless steel, entirely dismantled, easy to clean and ergonomic
- Improves user comfort and allows power mixers to continue running on its own

Gastro200 Stick Blender

电动搅拌机



Code	8020800
Power	200 Watts
Voltage	230 / 240 V
Speed	12,000 - 17,000 rpm
Switch	2 speed pulse security switch
Dimension (l x w x h)	Length 39.5 cm Immersion 29 cm

Features:

- Bamix® can do almost everything a large food process or can do - and it does it in any receptacle, even in a pot on the stove bamix® mixes, purées, emulsifies, aerates, chops, grinds etc.. It works extremely small but also large quantities.



Immersion Stick Blender

电动搅拌机



Code	7150901
Power	175 watts
Voltage	240 V/50 Hz
Control	2 speed switch
Dimension (l x w x h)	Length 22.5 cm Overall length 45.5 cm

Features:

- Long-life motor components and stainless steel attachments designed for food service applications.
- To purée soups and sauces right in the pan, cream butters, and mix batters with ease.
- Unit comes with handle, detachable 9" chopping shaft with poly sulfone cap.



Hand Blender

电动搅拌机



Code	8021600
Power	250 watts
Voltage	230 V, 50 Hz
2 Speed	15,000 / 20,000 rpm
Dimension	38 cm - 20cm shaft
Process quantity	20 litre
Continuous use	8 min

The hand blender from Kisag is efficient and robust. Highly versatile: thanks to its extremely strong stirring performance and multifunctional all-purpose blade it can be used for mixing, pureeing or whipping cream, mayonnaise, for grinding and chopping of nuts etc.

The device fits easily into your hand and offers great hygiene advantages:

- Stem, foot and blade made of stainless steel.
- Fixed mounted stem and foot as unit, without gaps: absolutely hygienic.
- Construction and special seals prevent absorption: no residues left in blending shaft. The food is never contaminated.



Food Processor 电动食物搅拌机



C 4

- Strong AISI 430 steel construction.
- Detached motor and bowl for a better thermal insulation.
- S/S bowl with handles and heavy bottom.
- High efficiency ventilated motor for continuous operation.
- Strong cutlery steel knives.
- Safe operations ensured by a system of micro switches on the lid.
- See-through lexan lid.
- Lid with opening to add ingredients during operation.
- Variotronic: speed control with stabilizer.
- C4 and C6 available with steplessly variable-speed drive.
- C15 available with 2 speeds.
- C15 HP7 with steplessly variable-speed drive and inverter as a standard.
- Standard: spatula and sharpening stones.
- Optional: serrated knives, emulsifying knives, knives for pesto sauce and knives to mix dough.

C 4

Code	8021904
Power	350 watts - 0.5 HP
Voltage	230 V, 50/60 Hz
Bowl capacity	3.3 L
Bowl filling level	1.5 L
Speed	2800 rpm
Dimension	35.5 x 30.5 x 25.5 cm
Net Weight	10 kg

C 4 V.V

Code	8021904-1
Power	350 watts - 0.5 HP
Voltage	230 V, 50/60 Hz
Bowl capacity	3.3 L
Bowl filling level	1.5 L
Speed	1500÷2800 rpm
Dimension	35.5 x 30.5 x 25.5 cm
Net Weight	10 kg



C 6

C 6

Code	8021905
Power	350 watts - 0.5 HP
Voltage	230 V, 50/60 Hz
Bowl capacity	5.3 L
Bowl filling level	3.1 L
Speed	2800 rpm
Dimension	35.5 x 30.5 x 32.0 cm
Net Weight	11 kg

XL1500 Food Processor 电动食物搅拌机



Code	8021000
Power	1500 watts

- 1500W motor:
This mighty machine features a powerful commercial grade induction motor tough enough to cope with the most demanding kitchen task
- Auto Pulse:
This clever and versatile feature retains the integrity of the foods being processed without pulverising ingredients
- Unique sealed drive:
The large bowl has an air volume of 3.25L and a wet working volume of up to 2.25L (when making soup and using Auto Pulse)

Multi Food Processor 搅拌机

BRAUN

Code	8021100
Power	600 watts
Voltage	230 V, 50/60 Hz
Bowl capacity	2 L
Auto pulse	Yes
Pre-set speed function	Yes
Pulse button	Yes

Intelligent programs
DualControl system with variable speed
Versatility of high-quality attachments
Versatility of high quality attachments
High-performance dough tool
BPA-free bowls and attachments



Table Top Electric Potato Peeling Machine 土豆去皮器

SIRMAN

PPJ6

Code	8021800
Power	370 watts - 0.5 HP
Voltage	230 V, 50 Hz
Capacity	6 kg
Dimension	55 x 40 x 44 cm
Net Weight	31 kg

- Made from AISI 304 Stainless steel.
- Self-tensioning poli-v belt drive.
- High efficiency ventilated motors for continuous operation.
- Stainless steel peeling disc.
- Easy to replace abrasive surface.
- Patented removable dish washing safe container and bottom peeling disc (no tools required)
- Automatic unloading system.
- Stainless steel outlet opening with quick and sealed locking.
- Easy service and easy access to the components.
- CE version with: E84
- Microswitch on the lid
- Microswitch on outlet opening
- One speed



Electric Potato Peeling Machine 土豆去皮器

SIRMAN

PPJ10SC

Code	8021310
Power	735 watts - 1HP
Voltage	230V, 50 Hz
Capacity	10-20 kg
Output	170 kg/h
Dimension	47.0 x 77.5 x 105.0 cm
Net Weight	41.5 kg

PPJ20SC

Code	8021320
Power	1100 watts - 1.5 HP
Voltage	230V, 50 Hz
Capacity	20-35 kg
Output	340 kg/h
Dimension	56.0 x 88.0 x 119.0 cm
Net Weight	52 kg

- Made from aisi 304 stainless steel.
- Self-tensioning poli-v belt drive.
- High efficiency ventilated motors for continuous operation.
- Stainless steel peeling disc.
- Easy to replace abrasive surface.
- Patented removable dish washing safe container and bottom peeling disc (no tools required).
- Automatic unloading system.
- Stainless steel outlet opening with quick and sealed locking.
- Adjustable stainless steel feet can be fixed to the floor.
- Easy service and easy access to the components





Electric Potato & Onion Peeling Machine 洋葱去皮器



Code	8021410
Power	368-662 watts
Voltage	400V/50Hz
2 Speeds	160 / 320 rpm
Capacity	10 kg
Output	170 kg/h
Dimension	47.0 x 77.5 x 136.0 cm
Net Weight	52 kg

- *Made from aisi 304 stainless steel.
- *Self-tensioning poli-v belt drive.
- *High efficiency ventilated motors for continuous operation.
- *Stainless steel peeling disc. * Easy to replace abrasive surface.
- *Patented removable dish washing safe container and bottom peeling disc (no tools required)
- *Automatic unloading system.
- *Stainless steel outlet opening with quick and sealed locking.
- *Adjustable s/s feet can be fixed to the floor.
- *Easy service and easy access to the components.
- *CE version with: microswitch on the lid, microswitch on outlet opening
- *2 Speeds, potato peeler / shell washer (pp/lc) requires 2 containers.

350, Electric Food Slicer with 3/16" Slice Blade 电动食品切片机



Code	8021500
Voltage	230V

- * Easy to clean stainless steel and aluminium construction.
- * Additional blade and pusher assemblies can be purchased separately for greater flexibility. Please note: pusher assemblies must match blade assemblies.
- * Unit dimensions: 292 mm (W) x 318 mm (H) x 432 mm (D) .
- * Comes complete with stainless steel wash guard for increased safety and sanitation.
- * Guard locks over blade cartridge for safe cleaning in dishwasher.

Spare Blade and Insert 刀片配件载体

CODE		
8021501	3/8"	Width Blade
8021502	3/16", 3/8"	Plastic Insert



Manual Salad Spinner, Orange Plastic 沙拉搅拌器



CODE	SIZE (l x w cm)	CAP (L)
2410110	33 x 43	10
2410120	43 x 52	20



Electric Salad Spinner, Orange Plastic 电动沙拉搅拌器



Code	2410320
Power	200 watts
Voltage	230V
Speeds	500 rpm
Capacity	20 L
Dimension	43 x 63 cm
Net Weight	8.3 kg

Milkshake/Drink Mixer



- A complete line of drink mixers with a soft design.
- Designed to commercial use, they meet all European and North-American safety requirements.
- White or chrome head, aluminium stem and die casting base for a perfect stability, no edges or seams for easier cleaning.
- Countertop (1 or 2 cups) or wall unit versions available.
- Transparent 550 cc Tritan cup or stainless steel cup on request.
- 900 cc stainless steel cup on 120 W version.
- Powerful ventilated motor for a longer life.
- Spindle with three aluminium and s/steel agitators for preparing milkshakes and drinks, or with a special round agitator for frozen coffees or for creamier results.
- Safety microswitch on the cup support (optional for non UE countries).
- Speed control on request.

Sirio 2

Code	7152102
Power	100 + 100 watts
Voltage	230V 50-60 Hz
Speeds	14,000 rpm
Capacity	2 x 0.55 L
Dimension	30.0 x 19.5 x 48.5 cm
Net Weight	5 kg



Sirio 2

Sirio 1

Code	7152101
Power	100 watts
Voltage	230V 50-60 Hz
Speeds	14,000 rpm
Capacity	0.55 L
Dimension	15.0 x 19.5 x 48.5 cm
Net Weight	2.5 kg



Sirio 1

Sirio 1 V.V

Sirio 1 V.V with Variable Speed

Code	8031100
Power	100 watts
Voltage	230V 50-60 Hz
Speeds	4000÷14,000 rpm
Capacity	0.55 L
Dimension	15.0 x 19.5 x 48.5 cm
Net Weight	2.5 kg

Milkshake / Drink Mixer

奶昔机



Code	7150201
Power	300 watts
Voltage	220V-240V, 50-60Hz
Motor	1/3 Hp
Dimension	17.1 x 16.5 x 52.0 cm

Code	7150301
Power	900 watts
Voltage	220V-240V, 50-60Hz
Motor	1/3 Hp
Dimension	31.75 x 22.86 x 52.0 cm



7150201

7150301

Versatile Drink and Food Prep - Great for everything from mixing ice cream shakes to "flashing" bar drinks to blending eggs, pancake, and waffle batter.

Performance - More powerful 1/3 Hp motor mixes up to twice as fast, so customers don't have to wait. Precision Motor - The motor is balanced to minimize vibration. Built to last with sealed, permanently lubricated ball bearings.

Two-Way Motor Activation - Operators can start and stop mixing action by inserting the cup into the cup guide



7150501

7150401

Rio Bar Blender

搅拌机



Code	7150401
Power	450 watts
Voltage	220V-240V, 50-60Hz
Motor	3/4 peak Hp input power
Container	Polycarbonate
Capacity	44 oz / 1.25 L
Dimension	20.3 x 16.51 x 40.64 cm

Code	7150501
Power	450 watts
Voltage	220V-240V, 50-60Hz
Motor	3/4 peak Hp input power
Container	Stainless Steel
Capacity	32 oz / 0.95 L
Dimension	20.3 x 16.51 x 40.64 cm

2 Speed control with pulse option. 4 Stainless steel cutting and mixing blades blend perfectly with ice. Durable 32 oz stainless steel container is made with measurement marks. Break resistant 44 oz polycarbonate container is able to snack up for storage



Tango Bar Blender

搅拌机



Code	7150601
Power	600 watts
Voltage	220V-240V, 50-60Hz
Motor	1 Hp
Container	Polycarbonate
Capacity	48 oz / 1.4 L
Dimension	22.86 x 16.51 x 43.18 cm

Timer plus 2 speeds and pulse for precision blending
Powerful 1 Hp Motor
All-Metal Drive Coupling is Built to Last
Durable Stainless Steel Blades
Stackable 48 oz. / 1.4 L Container



TEMPEST High Speed Bar Blender

搅拌机



Code	7150701
Power	880 watts
Voltage	220V-240V, 50-60Hz
Motor	3 Hp
Container	Polycarbonate
Capacity	64 oz / 1.8 L
Dimension	20.3 x 17.8 x 45.7 cm

Wave Action® System for Smooth Results with No Ice Chunks
2 Speeds, Jump Cycle, Pulse Button, and Timer for Precision Blending
Powerful 3 Hp Motor Satisfies the Demands of the Busiest Bars
All-Metal Drive Coupling and Stainless Steel Blades
Stackable 64 oz. / 1.8 L Container



Eclipse™ Enclosed Bar Blender

搅拌机



Code	8031201
Power	1000 watts
Voltage	220V-240V, 50-60Hz
Motor	3 Hp Input power
Container	Polycarbonate
Capacity	48 oz / 1.4 L
Dimension	28.6 x 21.6 x 47.0 cm

New QuietBlend™ technology and advanced Quiet Shield™ enclosure reduces noise to conversation level
Powerful 3 peak input power Hp motor
Lifetime warranty on motor drive coupling and stainless steel blade
Select from over 100 pre-programmed cycles; custom programs also available

Summit High Performance One Touch Bar Blender (Silent Shield) 搅拌机



Code	7150801
Power	880 watts
Voltage	220V-240V, 50-60Hz
Motor	3 Hp
Container	Polycarbonate
Capacity	64 oz / 1.8 L
Dimension	30.4 x 22.8 x 48.2 cm

Auto Blend "One Touch Sensor Blending" is a patent-pending technology for perfect drink consistency
 Hundreds of pre-programmed cycles for maximum flexibility
 Quiet Shield™ sound enclosure reduces blender noise
 Wave-Action® system is designed to continuously force mixture down into the blender for a super smooth drink profile
 USB port for future program updates



Commercial Kitchen Blender 搅拌机



Code	7151101
Power	600 watts
Voltage	220V-240V, 50-60Hz
Container	Stainless Steel
Capacity	64 oz / 1.8 L
Dimension	17.5 x 22.9 x 52.1 cm

2 Speed versatility with pulse option provides precision blending, mixing, chopping. 4 Stainless steel cutting and mixing blades ensure quick, thorough blending. Durable stainless steel container features dual metal clamps and handles for extra security during and after blending.



High Speed Kitchen Blender 搅拌机



Code	8031101
Power	750 watts
Voltage	220V-240V, 50-60Hz
Motor	3 Hp
Container	Polycarbonate
Capacity	64 oz / 1.9 L
Dimension	17.8 x 20.3 x 45.7 cm

Code	8031102
Power	750 watts
Voltage	220V-240V, 50-60Hz
Motor	3 Hp
Container	Stainless Steel
Capacity	64 oz / 1.9 L
Dimension	17.8 x 22.8 x 48.2 cm

Powerful 3 Hp motor (maximum output power) lets chefs puree soups, emulsify dressings, grind flours, and chop salsas and compotes
 Patented Wave-Action® Blending System, stainless steel blades
 Unique, one-touch chopping function with speed control thoroughly chops solid ingredients
 Adjustable Speed, Pulse, One-Touch Chopping with Speed Control
 Gauge for monitoring motor temperature
 Large 4 oz. dosing cup
 64-ounce break resistant polycarbonate container
 Patented container and blade design keeps ingredients circulating through the blades to ensure that contents are well-emulsified
 Patented jar pad sensor
 Temperature gauge alerts operator if motor overheats while blending back-to-back batches



8031101

8031102



Commercial Kitchen Blender 搅拌机



Code	8031200
Power	1,350 watts
Voltage	220V-240V, 50-60Hz
Motor	Variable Speed 700 - 15,000 rpm
Container	Stainless Steel
Capacity	4 L
Dimension	27.0 x 44.5 x 36.5 cm
Weight	6.5 kg

- Blends, mixes, stirs, whips, chops, mashes mixtures that are rich in liquids.
- Prepares paste, batter, dressings, herb oils, sauces, thickenings, soups, desserts, milk shakes, cocktails, fruit drinks, juices, etc.
- For restaurants, bars, diet kitchens, hospitals, schools, fast food outlets, the catering trade, supermarkets, etc.
- Generous jug volume of 4 litres and powerful heavy duty 1 350 watt motor.



Commercial Kitchen Blender 搅拌机



Code	7151001
Power	600 watts
Voltage	220V-240V, 50-60Hz
Motor	3/4 Hp
Container	Stainless Steel
Capacity	128 oz / 3.8 L
Dimension	25.4 x 22.9 x 55.8 cm

- 2 Speed versatility with pulse option provides precision blending, mixing, chopping. 4 Stainless steel cutting and mixing blades ensure quick, thorough blending. Durable stainless steel container features dual metal clamps and handles for extra security during and after blending.



Heavy Duty High Volume Kitchen Blender 搅拌机



3-Speed

Code	8030202
Voltage	230V, 50Hz
Motor	3.75 Hp
Variable Speed	1700 - 18,000 rpm
Container	Stainless Steel
Capacity	1 Gallon
Dimension	56.5 x 38.0 x 38.0 cm

Variable Speed

Code	8030203
Voltage	230V, 50Hz
Motor	3.75 Hp
Speeds	Low (15,800 rpm), Med (18,000 rpm), Hi/Pulse (20,800 rpm)
Container	Stainless Steel
Capacity	1 Gallon
Dimension	56.5 x 38.0 x 38.0 cm

Features:

- Easy to clean electronic membrane panel with 3 speeds and pulse.
- One gallon stainless steel container with two handles.
- Rubberized lid.
- Slow start feature.
- New dishwasher-safe one-piece jar pad for easy cleaning.

Advance Vita-Mix Bar Blender

搅拌机



Code	8030148
Power	750 - 850 watts
Voltage	220V-240V, 50-60Hz
Speed	37,000 rpm
Container	Polycarbonate
Capacity	1.4 L
Dimension	22.0 x 18.5 x 44.0 cm
Weight (Ship)	5.9 kg

2-Speed, complete with 1.4 Litre standard container blends between 120ml and 1.4 Litres durable polycarbonate container metal-to-metal driver contact for maximum durability

**Vita Prep 3 Kitchen Blender**

搅拌机



Code	7151201
Power	750 - 850 watts
Voltage	220V-240V, 50-60 Hz
Speed	Variable 1,000 - 24,000 rpm
Container	Polycarbonate
Capacity	2 L
Dimension	22.0 x 18.5 x 51.0 cm
Weight (Ship)	5.9 kg

Exceptional power and speed, combined with a specially configured steel blade assembly. All stainless steel blade assembly with sealed ball bearings.

**“TOUCH N GO 2” Bar Blender**

搅拌机



Code	7151301
Power	1,140 watts
Voltage	230V, 50-60 Hz
Motor	≈2 peak output horsepower motor
Container	Polycarbonate
Capacity	0.9 L
Dimension	23.5 x 26.7 x 49.2 cm
Weight	8.6 kg

- On-counter mounted model
- 34 programs and pulse switch
- 0.9 Ltr high-impact jug and Advance® blade
- ~2 peak output HP* motor
- Low profile and sound reducing cover

**Dragone Bar Blender**

搅拌机



Code	8030800
Power	450 watts
Voltage	230V, 50-60 Hz
Speed	18,000 rpm
Capacity	1.5L
Dimension	21.3 x 20.0 x 41.6 cm
Weight	3 kg

- Designed to meet the specific needs of the modern bar, it is particularly suitable for preparing smoothie, fruit and vegetables drinks.
- White or chrome body, no edges or seams for easy cleaning.
- Powerful ventilated motor.
- Transparent, unbreakable 1,5 lt tritan container is dishwasher safe and graduated with litres and UK/ USA gallons.
- Tight rubber lid with feed opening to add ingredients while the blender is working.
- Vulcanized rubber gears drive gives a high power transmission and quiet operation.
- 4-Blades stainless steel knife can be easily disassembled.
- Safety microswitch on the lid.
- Speed control on request.





Barmaster-Q, C/W Enclosure Blender

搅拌机



Code	8030700
Power	750 watts, 1 HP
Voltage	230V, 50-60 Hz
Speed	14,000 / 24,000 rpm
Capacity	2L
Dimension	24.0 x 23.0 x 67.0cm
Weight	5 kg

- Constructional and performance features like the orione vv, but with the added option of using:
- 20 Pre-set programs, of which 4 can be linked to 4 keys on the keypad and the other 16 can be recalled through the menu (all can be reprogrammed).
- 9 Programs set in self-learning mode.
- Display to view the programs and machine operation.
- Transparent silencing bell available on request.
- The square glass has been developed to ideally work with large quantities of ice, even dry. Same features of the round glass version, plus:
- Handy and practical: you can pour the product in 3 different directions.
- Perfect to prepare frozen drinks or smoothies with syrups and concentrates.
- Multi-point motor puller in stainless steel.



ORIONE FIVE Kitchen Blender

搅拌机



Code	8030905
Power	750 watts, 1 HP
Voltage	230V, 50 /60 Hz
Speed	14,000 / 24,000 rpm
Container	Stainless Steel
Capacity	5 L
Dimension	24.5 x 26.0 x 54.0 cm
Weight	7 kg

- Commercial blender, designed to meet the specific needs of bars, restaurants, canteens, etc. Is particularly suitable for preparing smoothies, fruit and vegetables drinks, purees, mixing sauces, pureeing soups, etc.
- Stainless steel body.
- Powerful ventilated motor for a longer use and life.
- Polyester lid with feed opening to add ingredients while the blender is working.
- Metal gears to process particularly hot products are available on request.
- Stainless steel knives holder is easy to disassemble from the container.
- 4 Blades stainless steel knife is easy removable.
- Magnetic safety microswitch on the lid.
- Nvr device prevents accidental starting of the blender.
- Standard speed control.



Mercurio Citrus Juicer with Lever Cover

榨果汁机



Code	8030300
Power	150 watts, 0.2 HP
Voltage	230V, 50-60 Hz
Speed	320 rpm
Bowl	Stainless Steel
Dimension	21.0 x 30.0 x 38.5 cm
Weight	6 kg

- Imposing, efficient, heavy-duty juicer.
- Anodized aluminium construction.
- AISI 304 stainless steel bowl and lever.
- Powerful ventilated motor with gear drive.
- Fixed or removable sieve available.
- Reamer is available in two sizes to squeeze any kind of citrus.
- Standard microswitch on the reamer.
- Optional speed control.
- Practical mat.

Apollo Citrus Juicer

榨果汁机



Code	8030400
Power	150 watts, 0.2 HP
Voltage	230V, 50-60 Hz
Speed	320 rpm
Bowl	Stainless Steel
Dimension	21 x 21 x 28 cm
Weight	3 kg

- Commercial easy to use citrus juicer with round design.
 - White or chrome body, no edges or seams for easy cleaning
 - Stainless steel bowl is removable for cleaning and is dishwasher safe, ABS bowl available on request
 - Reamer and sieve are one piece to squeeze with the maximum efficiency.
 - Aluminium stainless steel lever to avoid any food contact is available on request.
 - Patented safety microswitch on the cone allows to activate the juicer when the product is pushed down.
- The juicer is available without microswitch as well.
- Speed control on request.



Dyna Citrus Juicer

榨果汁机



Code	8030500
Power	200 watts, 0.2 HP
Voltage	230V, 50-60 Hz
Speed	1500 rpm
Bowl	Plastic
Dimension	22.0 x 33.0 cm
Weight	6.3 kg

- It is perfect for juicing oranges, lemons, limes and even grapefruits in high volume production.
- The perfect design allows for maximum juice extraction with minimum effort and easy clean up.
- It will juice over 150 oranges per hour.
- 240V, 200 watts max. And the shipping weighs is 14 lbs.
- The juicer meets all nsf standards for safety and sanitation.



Semi-Auto Orange Juicer F50

榨橙汁机



Code	8030600
Power	300 watts
Voltage	230V / 50-60 Hz
Production	20-25 fruits / min
Feeder Capacity	6-7 fruits
Storage Basket	4 kg
Fruit diameter	up to 80 mm
Dimension	47 x 37 x 73.5 cm
Weight	36.3 kg



Auto-Feed Orange Juicer F50A

榨橙汁机



Code	8031300
Power	460 watts
Voltage	230V / 50-60 Hz
Production	20-25 fruits / min
Feeder Capacity	12 kg
Fruit diameter	up to 80 mm
Dimension	47 x 62 x 78.5 cm
Weight	56 kg



F50 - F50 A

- Self Service
- Small dimension
- Made in stainless steel
- 7 litres capacity tank
- Controlled pressure squeezing
- Feeder
- Fruits counter
- Easy cleaning



Freezer Orange Juicer

榨橙汁机

frucosol

Code	8031400
Power	610 watts
Voltage	230V / 50-60hz
Production	20 -25 fruits / min
Feeder Capacity	12 kg
Fruit diameter	up to 80 mm
Tank Capacity	7 L
Dimension	58 x 72 x 179 cm
Weight	106 kg

Compact juicer of automatic working with a cooling system. High capacity automatic feeder, with turning plate easy to dismount.
Cooling system with a 7 litres deposit and non-drop faucet; the temperature can be controlled.



J 80 Ultra - J 100 Ultra Juice Extractor

robot coupe

Self regulating speed system
Patented removable foot and blade
A Robot Coupe exclusive patented system
Delivered with 1 stainless steel wall support



J 80 Ultra

Code	7151701
Power	700 Watts
Voltage	Single phase 230V/50/1 UK Plug
One speed	3000 rpm
Throughput	up to 120 litres/h
High-clearance	juice spout 162 mm
Delivered with	- 6.5 litre see through pulp container slots neatly under the ejector spout - Drip tray
Dimension (l x w x h)	235 x 535 x 502 mm
Gross Weight	12.5 kg



J 100 Ultra

Code	7151702
Power	1000 Watts
Voltage	Single phase 230V/50/1 UK Plug
One speed	3000 rpm
Throughput	up to 160 litres/h
High-clearance	juice spout 256 mm
Delivered with	- ejection chute for a continuous flow of pulp straight into a bin for continuous juicing - Large-capacity 7.2 litre table top see through pulp container - Drip tray
Dimension (l x w x h)	235 x 535 x 596 mm
Gross Weight	15.4 kg

Centrifugal Juice Extractor No.28 榨果汁机



Code	7151801
Power	1300 watts
Voltage	220 - 240 V - 50-60 Hz
Motor	3000 rpm (50 Hz) / 3600 rpm (60 Hz)
Dimension	48 x 32 x 52 cm
Weight	24 kg

Equipped with a powerful induction motor for intensive use.
Maximum juice extraction: excellent yield.
Perfect filtration: large basket with very fine sieve (0.5 mm / 0.02") offering a high quality juice.
Delivered with a special key for screwing and unscrewing the basket.
Introduction: 68 mm diameter.
Spout height: 222 mm (9") to make juice in a glass or in a jug.
Output: 100 l/h



Centrifugal Juice Extractor No.50 榨果汁机



Code	7151901
Power	800 watts
Voltage	220 - 240 V / 50-60 Hz
Motor	3000 rpm (50 Hz)
Dimension	47 x 26 x 45 cm
Weight	14 kg

Commercial juicer adapted to intensive use thanks to its powerful induction motor and its high output.
Perfect filtration: large basket with very fine sieve (0.5 mm / 0.02") offering a high quality juice.
Maximum juice extraction: excellent yield.
Extra wide feeding chute (79.5 mm): no need to cut apples, carrots, tomatoes...
Silent: perfect to make juice in front of the customer.
Exclusive Ezy-clean™ system: Removable bowl, basket and cover (no tool needed).
Spout height: 200 mm (8.6"), to make juice in glasses, jugs, and blender jars.
Output: 100 l/h



Centrifugal Juice Extractor No.68 榨果汁机



Code	7152001
Power	1300 watts
Voltage	220 - 240 V, 50-60 Hz
Motor	3000 rpm (50 Hz)
Dimension	56.2 x 33 x 60.6 cm
Weight	25 kg

The Miracle edition offers a high efficiency and is adapted to intensive use.
Perfect filtration for a high quality juice : large basket with very fine sieve (0.5 mm / 0.02").
Full stainless steel food-zone (no aluminum).
Wide feeding chute (79,5 mm diameter): no need to cut fruits and vegetables.
New generation patented Ezy-clean™ system II: removable bowl, basket and cover (no tool needed).
Extremely sturdy: shifter all in metal.
Spout height: 228 mm (9"), to make juice in a glass or in a jug.
Exceptional output: 140 l/h.



COLD PRESS JUICER #65

The first in-store commercial Juice press in the world !



PATENTED JUICING SYSTEM

Exclusive technology developed and patented by Santos.

Slow extraction of juice :

- preserving vitamins, nutrients, enzymes, and minerals
- Minimizing juice separation and oxidation
- Maximum juice extraction.



COMMERCIAL INDUCTION MOTOR

- Extremely reliable and long lasting
- Silent
- Allowing variable speed to juice any type of fruits, veggies, herbs...



XL CHUTE

Wide chute Ø79.5mm to juice whole fruits and vegetables.

No pre-cutting needed.



- Commercial cold press juicer: Aluminum body and stainless steel food zone. Equipped with a reliable induction motor.
- Speed variation: set your speed to get the juice you want (kale, spinach, wheatgrass, apple...).
- 3 filtrations sizes: delivered with 3 filters to make more or less pulpy juices.
- Easy to use and clean: Extra wide chute. Removable pusher and juicing system for an easy cleaning (dishwasher safe)
- Fresh cold pressed juice made on-demand, in front of the customer: Cold pressed juice retains the maximum amount of nutrients, enzymes, minerals and vitamins. Minimal juice separation.
- Exceptional yield: maximum juice extraction

Cold Press Juicer No65

榨果汁机

Code	8031500
Voltage	220V, 50-60Hz/1
Dimension	21 x 35 x 80 cm
Weight	20 kg

Ice Crusher 53

碎冰机



Code	7151401
Power	130 watts
Voltage	220 - 240 V, 50-60 Hz
Motor	73 rpm (50 Hz)
Dimension	35.3 x 23.6 x 47.4 cm
Weight	10 kg

It is equipped with a heavy duty and quiet induction motor.
It makes both fine and coarse ice in just one touch of a button.
2 functioning modes: automatic (automatically crushes all the ice placed in the tank) and manual (crushes the ice as long as you push the button).
Exceptional output: simply and quickly makes 1,2 kg of crushed ice in 30 seconds.



Electric Ice Cube Shaver

电刨冰机

HATSUYUKI

Code	8040132
Voltage	220 V, 50Hz Single Phase
Shaving Capacity	1.4-1.7 kg/min
Dimension	30.6 x 40.2 x 42.9 cm
Weight	15 kg

Spare Blade

刀片

CODE

8040132-1

- Shaved ice is fluffy, light and delicious.
- Safe operation guarantees automatic stop when lid is opened.



Electric Ice Cube Shaver

电刨冰机

HATSUYUKI

Code	8040277
Voltage	220 V, 50Hz Single Phase
Shaving Capacity	2.5/3 kg/min
Dimension	36 x 29 x 49.9 cm
Weight	22 kg

Spare Blade

刀片

CODE

8040277-1

- Shaved ice is fluffy, light and delicious.
- Safe operation guarantees automatic stop when lid is opened.



Electric Ice Cube Shaver

电刨冰机

HATSUYUKI

Code	8040318
Voltage	220 V, 50Hz Single Phase
Shaving Capacity	1.0-1.3 kg/min
Dimension	23 x 26.6 x 39.2 cm
Weight	9 kg

Spare Blade

刀片

CODE

8040318-1

- Shaved ice is fluffy, light and delicious.
- Safe operation guarantees automatic stop when lid is opened.





Economy Ice Cube Shaver

电刨冰机

Code	8040622
Power	182 watts
Voltage	220 V - 50Hz
Motor	0.25 HP
Dimension	40 x 29 x 42 cm
Weight	24 kg



Ice Block Shaver

电刨冰机

HATSUYUKI

Code	8040403
Voltage	220 V - 50Hz Single Phase
Shaving Capacity	1.8-2.2 kg/min
Dimension	35 x 40.2 x 58 cm
Weight	29 kg

Spare Blade

刀片

CODE

8040403-1



Ice Block Shaver

电刨冰机

HATSUYUKI

Code	8040507
Voltage	220 V - 50Hz Single Phase
Shaving Capacity	1.8-2.2 kg/min
Dimension	34.5 x 42.5 x 58 cm
Weight	23 kg



Electric Ice Block Shaver

电刨冰机

HATSUYUKI

Code	8041100
Voltage	230 V - 50/60Hz Single Phase
Shaving Capacity	1.8 / 2.2 kg/min
Dimension	355 x 40.2 x 56.5 cm
Weight	20 kg



Economy Traditional Ice Block Shaver 电刨冰机

Code	8040601
Shaving Capacity	1.36-9.5 kg/min
Dimension	43 x 39 x 69 cm
Weight	22 kg

Xtra Fine Shave 雪花冰

Code	8040602
Shaving Capacity	0.14-9.5 kg/min
Dimension	43 x 39 x 69 cm
Weight	22 kg



Electric Ice Block Shaver 电刨冰机

Code	8040724
Power	180 watts
Voltage	240V
Shaving Capacity	120 kg/h
Dimension	42 x 40 x 74 cm
Weight	43 kg



Table Top Electric Ice Cube Crusher 榨果汁机



Code	8041001
Power	150 watts
Voltage	230V, 50-60 Hz
Speed	800 rpm
Capacity	Jug - 3 L, Bowl - 2 L
Dimension	20.5 x 28.5 x 49.1 cm
Weight	5.2 kg

- Professional ice crusher, an indispensable bar tool for preparing drinks and frozen cocktails and in the restaurant for displaying fish or fresh foods.
- Crushes any ice cubes made with an ice cube machine up to 40x40mm at -3° C.
- Its discharge adjustment lets you regulate the average size of the crushed ice.
- Extruded aluminium body, stainless steel container, food-grade ABS opening and s/steel blades.
- Ventilated motor with gear transmission for prolonged use, micro-switch on the lid for maximum operator safety.





Electric Ice Crusher

碎冰机



Code	8040900
Power	350 watts
Voltage	230V, 50-60 Hz
Motor	12000 rpm
Blade Speed	1500 rpm
Capacity	2 L
Dimension	36.5 x 21 x 29.5 cm
Weight	8.5 kg

- Triton allows to crush ice in different sizes by adjusting the blade:
Finely crushed ice for the traditional Italian granitas.
Flakes for frozen cocktails or to serve or display cold dishes.
- Safety microswitch on the feeding mouth.
- Safety microswitch on the collecting tray.
- Polished aluminium feeding mouth.
- Stainless steel parts and details.
- Aluminium and stainless steel internal structure.
- Body and tray are made from thermoformed alimentary plastic.
- Ribbed belt for low power absorption.



* limited stock

Cervino-5-Y11 Blast Freezer / Chiller

冷凍機



Code	8051800
Power	1200 watts
Voltage	230V 50Hz
Chilling	+70°C to +3°C, 12 kg in 90 min
Freezing	+70°C to -18°C, 9 kg in 240 min
Number Of Tray	5 x 1/1 GN or 400 x 600 mm pastry-trays
Dimension	75 x 74 x 83 cm
Weight	90 kg

- Designed for high efficiency and ease of use.
- Made from stainless steel.
- It can accept both 1/1 gastronorm trays or 60x40 cm trays (not on Lampo).
- Cervino 5: distance between shelves cm 5.
- Blast freezing/chilling programs and hold function.
- Blast freezing/chilling programs and hold function.
- R404A Gas.
- Heated door gasket avoids door's clogging.
- Cervino Gelateria with SOFT freezing program.
- Suitable for stacking max kg 100



Food Processor

食物处理器

Pacojet 1



Code	8051400
Power	1000 W
Voltage	220-240 V / 50-60 Hz
Beaker Capacity	1.0 Liter / 1.2 quarts (135 mm / 5.2", Ø: 130mm / 5")
Max. Fill Volume	0.8 Liter / 28 fl. oz.
Ideal Pacotizing Temp. for Frozen Foods	-22 °C / -8 °F
Rotation Speed	Motor: 10000 rpm, Pacotizing Blade: 2000 rpm
Air Pressure	approx. 1.2 bar / 17 lb. in.
Dimensions	498 x 182 x 360 mm
Net Weight	14.0 kg / 30 lb

Pacojet 2



Code	8051401
Power	950 W
Voltage	220-240 V / 50-60 Hz
Beaker Capacity	1.0 Liter / 1.2 quarts (135 mm / 5.2", Ø: 130mm / 5")
Max. Fill Volume	0.8 Liter / 28 fl. oz.
Ideal Pacotizing Temp. for Frozen Foods	-22 °C / -8 °F
Rotation Speed	Motor: 6000 rpm, Pacotizing Blade: 2000 rpm
Air Pressure	approx. 1.2 bar / 17 lb. in.
Dimensions	498 x 182 x 360 mm
Net Weight	15.7 kg / 34 lb

Spare Part / Accessories



Code 8051500
Desc Container with lid



Code 8051501
Desc Beaker Lid



Code 8051502
Desc Standard Blade



Code 8051503
Desc Gold Blade



Code 8051504
Desc Protective Outer Beaker



Code 8051505
Desc Rinsing Insert



Code 8051506
Desc Spray Guard



Code 8051507
Desc Cleaning Insert



Code 8051508
Desc Sealing Ring



Code 8051509
Desc Coupe Set



Chocolate Fountain Classic Series 巧克力喷泉



27" Height Classic Series

Code	8250101
Power	600 watts
Voltage	230V / 50-60Hz
Number of Tier	3
Chocolate Capacity	4.5 kg
Dimension (l x d x h)	28 x 28 x 66 cm
Weight	13.6 kg

40" Height Classic Series

Code	8250102
Power	690 watts
Voltage	230V / 50-60Hz
Number of Tier	4
Chocolate Capacity	10 kg
Dimension (l x d x h)	41 x 41 x 102 cm
Weight	39.5 kg

Add an eye-catching centerpiece to your business with the Buffet Enhancements stainless steel 3 tier (27") / 4-tier (40") commercial chocolate fountain! This 27" / 40" tall fountain features a fine brushed exterior with a 10 lbs. & 22lbs. chocolate capacity respectively, letting you load up on a large quantity of smooth, delicious chocolate. The movable tiers slide onto the center support tube with O rings so you can create your own shapes and patterns. Unlike other chocolate fountains, they are easily disassembles and packs into the included ABS carrying case, making it perfect for commercial use and transportation from event to event.

Designed specifically to provide reliable durability through repeated commercial use, this fountain's heavy duty main shaft bearing and 1 hp direct drive motor ensure long-lasting durability, while the chocolate is kept between 105 and 110 degrees Fahrenheit for maximum flow and flavour. A precision stainless steel auger circulates the chocolate from the bottom of the fountain back to the top, and the top cap, auger, outer tube, and tiers are all dishwasher safe for fast and easy cleaning.

Sneeze Guard



Sneeze Guard for 27" Chocolate Fountain

Code	8250201
Dimension (l x d x h)	30.5 x 30.5 x 46 cm
Material	Clear Acrylic with Stainless Steel Frame

Sneeze Guard for 40" Chocolate Fountain

Code	8250202
Dimension (l x d x h)	43 x 43 x 81 cm
Material	Clear Acrylic with Stainless Steel Frame

Ensure your chocolate fountain is safe from wind and airborne contaminants with the Buffet Enhancements sneeze guard! This sneeze guard covers the majority of your chocolate fountain to keep it safe during windy days or in large crowds, and it leaves a portion of your fountain available to your customers for easy access. For long-lasting durability, this guard features a stainless steel frame with curved, curved acrylic walls.

The Traditional Chocolate Fountain 巧克力喷泉

The Entertainer Classic Series 24" Height

Code	8250301
Power	250 watts
Voltage	230V / 50-60Hz
Number of Tier	2
Chocolate Capacity	3 kg
Dimension (l x d x h)	34 x 34 x 61 cm
Weight	8.2 kg

The Indulgence Series 31" Height

Code	8250302
Power	450 watts
Voltage	230V / 50-60Hz
Number of Tier	3
Chocolate Capacity	6 kg
Dimension (l x d x h)	40.8 x 40.8 x 79.2 cm
Weight	15.9 kg

The Crowd Pleaser Series 43" Height

Code	8250303
Power	500 watts
Voltage	230V / 50-60Hz
Number of Tier	4
Chocolate Capacity	15 kg
Dimension (l x d x h)	49.5 x 49.5 x 110.3 cm
Weight	27.3 kg



Entertainer 8250301



Indulgence 8250302



Crown Pleaser 8250303

Entertainer Series

The Entertainer is the smallest commercial chocolate fountain on the market. It is ideal for coffee shops, cafés, restaurants, and in-home functions that typically serve 20 to 40 guests. It has 2 tiers and a crown and stands at a height of 611mm.

Indulgence Series

The Indulgence chocolate fountain CF2 is ideal for coffee shops, cafés, restaurants, buffets, function centres, in-home entertaining, or any functions that typically serve 40 to 100 guests. It has 3 tiers and a crown, and stands at a height of 792mm.

Crowd Pleaser Series

The Crowd Pleaser chocolate fountain CF3 is a unique 2-in-1 fountain that can be optionally setup to two different size configurations. It is ideal for restaurants, buffets, hotels, function centres, or any functions that typically serve 80 to well over 600 guests. It has 3/4 tiers and a crown, and stands at a height of 1103mm, or 1227mm with optional extension.

The Cascade Waterfall Chocolate Fountain 巧克力噴泉

The Rivulet Series 28" Height

Code	8250401
Power	250 watts
Voltage	230V / 50-60Hz
Chocolate Capacity	3 kg
Dimension (l x d x h)	30 x 30 x 72 cm
Weight	9.5 kg

The Waterfalls Series 39" Height

Code	8250402
Power	450 watts
Voltage	230V / 50-60Hz
Chocolate Capacity	6 kg
Dimension (l x d x h)	40.8 x 40.8 x 99.2 cm
Weight	18.5 kg

The Niagara Series 44" Height

Code	8250403
Power	500 watts
Voltage	230V / 50-60Hz
Chocolate Capacity	15 kg
Dimension (l x d x h)	49.5 x 49.5 x 113.1 cm
Weight	28 kg



Rivulet 8250401

Waterfalls 8250402

Niagara 8250403

Cascade Rivulet Series

The new Rivulet cascade chocolate fountain CF1C is from the new and innovative cascade range which is unlike anything currently on the market today. It is ideal for coffee shops, cafés, restaurants, buffets, function centres, in-home entertaining, or any functions that typically serves up to approx. 40 guests. It has numerous cascade style tiers headed by a crown, and stands at a height of 723mm.

Cascade Waterfalls Series

The new Waterfalls cascade chocolate fountain CF2C is from the new and innovative cascade range which is unlike anything currently on the market today. It is ideal for restaurants, cafés, hotels, function centres, or any functions that typically serve 40 to 100 guests. It has numerous cascade style tiers headed by a crown, and stands at a height of 992mm.

Cascade Niagara Series

The new Niagara cascade chocolate fountain CF3C is from the new and innovative cascade range which is unlike anything currently on the market today. It is ideal for restaurants, buffets, hotels, function centres, or any functions that typically serve 80 to well over 600 guests. It has numerous cascade style tiers headed by a crown, and stands at a height of 1131mm.

The Cascade River of Dream Chocolate Fountain 巧克力喷泉

The River of Dream 37" Height

Code	8250404
Power	500 watts
Voltage	230V / 50-60Hz
Chocolate Capacity	7 kg per side (total 14 kg)
Dimension (l x d x h)	50 x 50 x 93.5 cm
Weight	29.5 kg

The River of Dreams JUMBO Series 55" Height

Code	8250405
Power	500 watts
Voltage	230V / 50-60Hz
Chocolate Capacity	8 kg per side (total 16 kg)
Dimension (l x d x h)	50 x 50 x 140 cm
Weight	37.5 kg

The Whirlpool Triple Choc Series 40" Height

Code	8250406
Power	550 watts
Voltage	230V / 50-60Hz
Chocolate Capacity	6 kg per side (total 12 kg)
Dimension (l x d x h)	49.5 x 49.5 x 104 cm
Weight	46 kg



River of Dream
8250404



River of Dream Jumbo
8250405



Whirlpool Triple Choco
8250406



Cascade River of Dreams Series

The Rivers of Dreams cascade chocolate fountain CF4C is an innovative chocolate fountain unlike anything currently on the market. Two flavours of chocolate running at the same time providing awesome spectacle and tasters delight. Perfect for buffets, hotels, function centres, or a regular attraction at any venue. It stands at a height of 935mm.

Cascade River of Dreams JUMBO Series

The new Rivers of Dreams Jumbo chocolate fountain CF4CJ is the latest addition to our innovative range of cascade chocolate fountains which is unlike anything currently on the market. Two flavours of chocolate running at the same time providing awesome spectacle and tasters delight. Perfect for buffets, hotels, function centres, or a regular feature at any venue. It stands at a height of 1400mm.

Cascade Whirlpool Triple Choco Series

The new Whirlpool Triple Choc chocolate fountain CF5C is the ONLY TRIPLE CHOCOLATE FOUNTAIN in the world, and is the latest addition to our innovative range of cascade chocolate fountains which is also unlike anything currently on the market. Three flavours of chocolate running at the same time providing awesome spectacle and tasters delight. The sloping tiers are available in glass and stainless steel. Perfect for buffets, hotels, function centres, or a regular attraction at any venue. It stands at a height of 1040mm.



8061111



8061123

Softcooker S

热循环器

1/1 GN



Code	8061121
Power	1700 watts
Voltage	230V/50Hz
Temperature	40 ÷ 115
Bowl Capacity	26.5 L
Filling level	22 L
Dimension	56.5 x 36 x 30 cm
Weight	16 kg

2/3 GN



Code	8061123
Power	1150 watts
Voltage	230V/50Hz
Temperature	40 ÷ 115
Bowl Capacity	16.5 L
Filling level	14 L
Dimension	39 x 36 x 30 cm
Weight	5 kg

- Low temperature cooking device with water static heating.
- Stainless steel structure and 1/1 GN made of stainless steel
- Practical handles to carry it easily
- Powerful shock-proof coated heating elements in contact with tank bottom
- Electronic control system of the temperature with working temperature display
- Same control system of Softcooker with of 0,2°C.
- 5 storable programs
- Temperature setting in °C and °F.
- Equipped with lid
- R versione with tap for discharging water.



Y09

Wi-food

Softcooker

热循环器



Y09

Code	8060100
Power	2000 watts
Voltage	230V/50Hz
Temperature	40 ÷ 115
Dimension	13 x 26 x 38 cm
Weight	4.5 kg

Wi-Food

Code	8060101
Power	2000 watts
Voltage	230V/50Hz
Temperature	40 ÷ 115
Dimension	13 x 26 x 38 cm
Weight	4.5 kg

- High precision warmer with temperature control.
- Working temperature display.
- Ip x3 protection rated stainless steel structure.
- Can be applied to the pot by means of a clamp. (Max depth 16,5 cm)
- Best performances up to 50 lt.
- Working temperature from 20 to 100° c, accuracy 0,03°C.
- Protection device switches off the warmer in case of accidental use outside the liquid.
- Circulating pump to help the best product mixing.
- Temperature sensor to prevent overload and overheating.
- A convenient stainless steel handle makes it easy to carry.

- Wi-Food SOFTCOOKER lets you access a vast number of tried and tested recipes via a free app. Recipes can be saved and shared, your restaurant or business can be advertised, and your comments recorded and recalled in just a few clicks. And all this comes from a powerful, flexible cooker capable of holding up to 80 litres of water, and with a practical, intuitive and high resolution touch-screen display. Winner of the SMART LABEL award at Host 2015.
- Anodized aluminium frame.
- Wide IP 67 touch display 5".
- Easy to handle holder.
- Free APP downloadable from www.softcooker.com
- More units can be managed from the APP.
- Multiple cooking stages can be managed by the APP. .

Container for Softcooker Y09 / Wi-Food



1/1 GN

Code	8060100-1
Size	1/1 GN
Dimension	56.5 x 36.0 x 23.0 cm
Weight	7.7 kg

2/1 GN

Code	8060100-2
Size	2/1 GN
Dimension	65.0 x 53.0 x 23.0 cm
Weight	13 kg

Thermal Blender MyCook 热搅拌机

taurus
PROFESSIONAL

Code	8060200
Power	800 watts
Voltage	230V/50Hz
Induction Power	1000 watts
Temperature	120°C
Bowl Capacity	2 L
Dimension	36 x 30 x 29 cm
Weight	9 kg

- Semi-professional thermal blender.
- Practical, must-have kitchen aid.
- Powerful motor separated from the cooking zone.
- Induction heating which halves the time required to reach desired temperature.
- Minicooker supplied with 5 kg scales with tare.
- Speed changer.
- Potentiometer for cooking to 120°.
- Practical 2 L stainless steel bowl.
- Knife hub quick to dismantle for easy cleaning.
- Lid with safety closure.
- Spatula, butterfly mixer and perforated basket supplied.
- Add ingredients cap with measuring device.
- Sautéed vegetable program.
- Steam cooking set optional.



THERMOMIX TM-5 热搅拌机

Thermomix

Code	8061300
Power	500 watts
Voltage	240V/50Hz
Speed	100 to 10,700 rpm
Heating System	1,000 watts
Integrated Scales	5 to 3,000g in 5g increments (to max 6kg)
Bowl Capacity	2.2 L
Dimension	32.6 x 33.3 x 33.5 cm
Weight	7.7 kg

Smoking Gun 烟熏枪

 **PolyScience**
Innovative Culinary Technology

Code	8061400
Shipping Dimension	25.4 x 23.5 x 5.7 cm
Shipping Weight	0.65 kg

The Smoking Gun makes your kitchen and bar creations appealing and unique. There are virtually no other methods that allow you to make such big flavor and aroma differences so easily. The Smoking Gun offers an alternative to traditional smoking methods. Today turning even salads, chocolate, meringue, sauces, butters and fruit into unique new culinary sensations is possible by adding a measured amount of natural, cool smoke. The Smoking Gun makes adding flavors and adjusting their intensities easy.

- Includes four AA batteries and two ½ ounce sample jars of Applewood and Hickory smoking wood chips.



Classic Smokehouse Wood Kit

 **PolyScience**
Innovative Culinary Technology

Code	8061401
Flavours	Hickory, Mesquite, Applewood and Cherrywood
Capacity	4 oz

Hickory & Mesquite: Strong and earthy flavours for rich foods like beef, pork and vegetables.
Apple & Cherry: Slightly sweet, fruity flavour for delicate meats. Pairs very well with whipped butter and cocktails.



Dehydrator 脱水机



5 Trays

Code	8061500-BK / 8061500-WH
Power	440 watts
Voltage	230V/50Hz
Adjustable Thermostat	40°C to 74°C
Dimension	43 x 48.5 x 21.5 cm
Color	Black / White

- 5 large trays, 8 sq ft of drying space
- 26 Hour Timer
- 5-inch fan



9 Trays

Code	8061600-BK / 8061600-WH
Power	600 watts
Voltage	230V/50Hz
Adjustable Thermostat	40°C to 74°C
Dimension	43 x 48.5 x 32 cm
Color	Black / White

- 9 large trays, 15 sq ft of drying space
- 26 Hour Timer
- 7-inch fan



Electric Raclette Cheese Melter 芝士奶酪胶机

Party Series, ¼ Loaf

Code	8260100
Power	600 watts
Voltage	230V
Type of Cheese Loaf	1/4 size, 3 kg
Dimension (l x d x h)	24 x 26 x 11.7 cm
Weight	2.8 kg

Tabletop device for small and tasty raclettes. For a quarter round cheese. The cheese is placed on a rotatable chrome-plated cheese holder then under the heating coil

Ambiance Series, ½ Loaf

Code	8260101
Power	1,000 watts
Voltage	230V
Type of Cheese Loaf	1/2 size, 6 kg
Dimension (l x d x h)	48 x 27 x 32 cm
Weight	5.4 kg

Traditional device for a half round cheese. Tilt able combination cheese holder for round and rectangular cheeses, height adjustment by rotating the spindle. Adjustable centering of the cheese holder under the heater depending on the width of the cheese. On / off switch.



Vacuum Sealing Machine

真空包装机



- Exceptional design to reduce machine size and improve its practicality.
- Large and wide bell in thermoformed plexiglass on mod. 50 and 70, injection on mod. 30 and 40.
- Easily removable sealing bar.
- Extremely easy to clean thanks to a perfectly level product counter.
- Automatic cover lift operated by pneumatic pistons.



W8 30 Easy BX

Code	8060930
Power	350 watts
Voltage	230V/50Hz
Vacuum Pump	8 mc/h
Sealing bar	31 cm
Dimension	40.2 x 52.5 x 40.8 cm
Weight	38 kg

W8 40 BX

Code	8060940
Power	750 watts
Voltage	230V/50Hz
Vacuum Pump	21 mc/h
Sealing bar	41 cm
Dimension	49.3 x 58.5 x 42.2 cm
Weight	56 kg

W8 40 BX (with Printer)

Code	8060941
Power	750 watts
Voltage	230V/50Hz
Vacuum Pump	21 mc/h
Sealing bar	41 cm
Dimension	49.3 x 58.5 x 42.2 cm
Weight	56 kg

W8 50 BX

Code	8060950
Power	750 watts
Voltage	230V/50Hz
Vacuum Pump	21 mc/h
Sealing bar	51 cm
Dimension	60.9 x 64.0 x 42.0 cm
Weight	70 kg

Vacuum Sealing Machine

真空包装机



Code	8061025
Power	100 watts
Voltage	230V/50Hz
Vacuum Pump	4 mc/h
Sealing bar	26 cm
Dimension	32.0 x 56.0 x 25.7 cm
Weight	30 kg

- A compact and fast machine for small sized products, ideal combined with low temperature cooking instruments like the Softcooker.
- Easily settable vacuum and sealing time.
- Easily removable sealing bar.
- Busch suction pump.
- Display of vacuum percentage and time to countdown.
- Last setting can be saved in memory
- Cycle counter.
- Pump preheating and oil cleaning cycle
- Change oil message.
- Timed external vacuum.
- Manual cover lift.



Vacuum Bag for Sealing

真空袋

CODE	SIZE (l x w cm)	SPEC
8061215	15 x 20	80µm Thick 1000 Pcs Per Box
8061220	20 x 30	80µm Thick 1000 Pcs Per Box
8061230	30 x 40	80µm Thick 1000 Pcs Per Box
8061231	30 x 40	not for cooking
8061235	35 x 45	not for cooking





Slush Machine 电动雪泥机

2 Tank

Code	8060602
Power	1100 watts
Voltage	220V / 50-60Hz /5.5A
Cooling Time	40 min to 1 hr
Capacity	12L x 2
Dimension	43 x 49 x 79 cm
Weight	48 kg



3 Tank

Code	8060603
Power	1750 watts
Voltage	220V / 50-60Hz /5.5A
Cooling Time	40 min to 1 hr
Capacity	12L x 3
Dimension	63 x 49 x 79 cm
Weight	69 kg

Electric Drink Dispenser 冷水机 (电)



2 Tank

Code	8060802
Power	420 watts
Voltage	220/240V / 50-60Hz /2.8A
Cooling Time	30 min to 1 hr
Capacity	12L x 2
Dimension	41 x 46 x 59 cm
Weight	28 kg



3 Tank

Code	8060803
Power	500 watts
Voltage	220V / 50-60Hz /5.5A
Cooling Time	40 min to 1 hr
Capacity	12L x 3
Dimension	61 x 46 x 59 cm
Weight	34 kg

Wall Mount Hot Water Urn 钢电水桶

birko



7.5 L

Code	4140307
Voltage	220-240V
Delivery	45 cups
Capacity	7.5 L
Dimension	51 x 36.5 x 24 cm
Weight	3 kg

20 L

Code	4140320
Voltage	220-240V
Delivery	120 cups
Capacity	20 L
Dimension	49 x 34 x 63 cm
Weight	4 kg

Electric Hot Water Urn 钢电水桶



Benefits

- **High quality & low maintenance** – Chrome plated brass tap at a comfortable cup height and polished stainless steel body with vented, twist-to-lock lid. Welded joints for superior corrosion resistance and effortless cleaning
- **Temperature control** – thermostat has variable settings, for greater control over the boiling water
- **Safety** – Push button over temperature cut out turns off the power if the urn boils dry and the non-drip tap prevents accidents and mess.
- **All you need** – indicator light, water level gauge, heat-resistant knobs, easy-lift safety handles and enclosed lockable lid.

10 L

Code	4140211
Voltage	220-240V
Delivery	40-50 cups/hr
Capacity	10 L
Dimension	Ø 25.3 x 39.0 cm
Weight	3 kg

20 L

Code	4140222
Voltage	220-240V
Delivery	80-100 cups/hr
Capacity	20 L
Dimension	Ø 30.0 x 45.7 cm
Weight	4 kg

30 L

Code	4140233
Voltage	220-240V
Delivery	130-150 cups/hr
Capacity	30 L
Dimension	Ø 35.4 x 48.0 cm
Weight	4.75 kg

40 L

Code	4140244
Voltage	220-240V
Delivery	175-200 cups/hr
Capacity	40 L
Dimension	Ø 35.4 x 58.0 cm
Weight	5 kg

Wall Mounted Electric Water Heater 电煮水器

6 Gal

Code	5171506
Voltage	220V
Power	2000 Watts
Capacity	6 Gal
Dimension	35.0 x 30.0 x 56.0 cm

8 Gal

Code	5171508
Voltage	220V
Power	2500 Watts
Capacity	8 Gal
Dimension	35.5 x 23 x 61.5 cm

10 Gal

Code	5171510
Voltage	220V
Power	3000 Watts
Capacity	10 Gal
Dimension	40.0 x 25.0 x 67.0 cm



Electric Water Heater 电煮水器

15 Gal

Code	5171615
Voltage	220V
Power	2000 Watts x 2
Capacity	15 Gal
Dimension	43.0 x 28.0 x 81.0 cm

20 Gal

Code	5171620
Voltage	220V
Power	2000 Watts x 2
Capacity	20 Gal
Dimension	46.0 x 30.5 x 92.0 cm

30 Gal

Code	5171630
Voltage	220V
Power	3000 Watt x 2
Capacity	30 Gal
Dimension	55.8 x 38.0 x 112.3 cm

40 Gal

Code	5171640
Voltage	220V
Power	3000 Watts x 2
Capacity	40 Gal
Dimension	60.9 x 40.6 x 116.8 cm





Stainless Steel Water Heater Stand 电煮水器用底座

For 15 Gal

Code 5171715
Dimension 43.0 x 28.0 x 81.0 cm

For 20 Gal

Code 5171720
Dimension 46.0 x 30.5 x 92.0 cm

For 30 Gal

Code 5171730
Dimension 55.8 x 38.0 x 112.3 cm

For 40 Gal

Code 5171740
Dimension 60.9 x 40.6 x 116.8 cm



Electric Coffee / Tea Urn (2-Tap) 二管型煮咖啡炉

6 Gal

Code 5171806
Voltage 220V
Power 3000 Watts
Capacity 6 L
Dimension 38.0 x 30.5 x 48.3 cm

8 Gal

Code 5171808
Voltage 220V
Power 5000 Watts
Capacity 8 L
Dimension 48.3 x 28.0 x 66.0 cm



Electric Coffee / Tea Urn (3-Tap) 三管型煮咖啡炉

6 Gal

Code 5171906
Voltage 220V
Power 3000 Watts
Capacity 6 L
Dimension 38.0 x 30.5 x 48.3 cm

8 Gal

Code 5171908
Voltage 220V
Power 5000 Watts
Capacity 8 L
Dimension 48.3 x 28.0 x 66.0 cm

10 Gal

Code 5171910
Voltage 220V
Power 6000 Watts
Capacity 10 L
Dimension 50.8 x 35.0 x 66.0 cm



Twin Tank Coffee Urn 双桶煮咖啡炉



1 Phase

Code 8070101
Power 7000 watts
Capacity 3 L
Amp 29A

The cecilware CL100n double 3 gallon push button coffee urn. Electro-mechanical timer. Automatically replenishes the urn jacket with fresh water as soon as it runs low to help minimize downtime. Automatic coffee urn features an adjustable bypass system that allows you to change the strength of the coffee to bring out its full-body taste, while an agitation system automatically blends coffee at the end of each brew cycle. Compact construction is a valuable asset to any food service operation with limited counter top space. Coffee urn must be hard wired; it does not come with a cord and plug. Stainless steel construction dimensions: 33-1/2" h x 28-1/2" w x 17-1/2" d 1/4" water line required

Electric Coffee Maker / Percolator

电咖啡冲泡壶

West Bend.



8070210



8070255



8070236

100 Cups

Code 8070210
Capacity 23.5 L

55 Cups

Code 8070255
Capacity 13 L

36 Cups

Code 8070235
Capacity 8.5 L

Interior water level markings for easy and accurate filling.
Twisto-secure cover helps minimize accidental spillage.
Serving light indicates end of brewing cycle.
Two-way drip less faucet for one cup or continuous serving.
Heat resistant handles, base and trim.

Glass Coffee Decanter
玻璃咖啡壶

Curtis

Code 4100501
Capacity 64 oz

Double Electric Coffee Warmer
双头咖啡保温机

Curtis

Code 4100401
Power 2 x 100 watts
Dimension 34.9 x 17.1 x 6.0 cm

Economy Electric Coffee Warmer
经济型咖啡保温机

8070301

Single

Code 8070301
Power 60 watts
Dimension 24.5 23.0 x 8.0 cm



8070302

Double

Code 8070302
Power 120 watts
Dimension 35.8 x 21.8 x 8.0 cm

Polycarbonate Coffee Decanter
胶身钢底咖啡壶

Code 8070463
Capacity 64 oz

SUNNEX®



Electric Dough Mixer 电动搅拌机 (不带安全网)



* Safety net shown are optional. Standard model do not come with safety net.



SP-22H

Code 5173525
Power 550 Watts, 0.75 hp
Voltage 230V/50Hz/1ph
Capacity 25 L
Dimension 56 x 55 x 91 cm
Weight 110 kg

Code 5173525A
with safety net

Speeds: (agitator rpm)
1. Low speed 98
2. Intermediate speed 199
3. High speed 341, 24Qt. (23.75 Litres) high quality stainless steel bowl



SP-30H

Code 8080130
Power 750 Watts, 1 hp
Voltage 230V/50Hz/1ph
Capacity 30 L
Dimension 67 x 55 x 117 cm
Weight 180 kg

Code 8080130A
with safety net

Speeds: (agitator rpm)
1. Low speed 85
2. Intermediate speed 152
3. High speed 293, 30qt. (30 Litres) high quality stainless steel bowl



SP-40HA

Code 8080134A
Power 1200 Watts, 1.5 hp
Voltage 230V/50Hz/1ph
Capacity 40 L
Dimension 75 x 65 x 131 cm
Weight 250 kg

* come with safety net.



SP-60HA

* come with safety net.

Code 8080160A
Power 2250 Watts, 3 hp
Voltage 380-415V/50Hz/3ph
Capacity 60 L
Dimension 78 x 65 x 131 cm
Weight 270 kg

Speeds: (agitator rpm)
1. Low speed 83
2. Intermediate speed 149
3. High speed 269, 60Qt. (60 Litres) high quality stainless steel bowl



SP-B80HI

* come with safety net.

Code 8080280A
Power 2250 Watts, 3 hp
Voltage 380-415V/50Hz/3ph
Capacity 80 L
Dimension 108 x 79 x 156 cm
Weight 445 kg

Speeds: 4 Speed (agitator rpm)
1. Low speed 59
2. Four Speeds 62, 108, 182, 320 rpm
3. High speed 356, 80Qt. (80 Litres) high quality stainless steel bowl

Table Top Dough Mixer (SP-502A)

台式和面机



Code	5173205
Power	750 watts
Voltage	220V/50Hz/1
Speed	31-490 rpm
Capacity	5 qt
Dimension	40.0 x 31.0 x 45.5 cm
Weight	15 kg

Features:

- Satisfying the demanding professional needs of the catering, restaurant and bakery.
- 750W horse power motor.
- 5 Quart stainless steel bowl with handle.
- Agitator moves clockwise and shaft moves counterclockwise to reach every part of the bowl.
- It mixes all the ingredients thoroughly and there is no need to rotate the bowl.
- Comes with kneading, mixing and whipping equipment.



Table Top Dough Mixer (SP-800)

台式和面机



Code	5173408
Power	200 watts , 0.25 hp
Voltage	220V/50Hz/1
Speed	133/282/585 rpm
Capacity	8 qt
Dimension	47 x 28 x 58 cm
Weight	25 kg

Features:

- Satisfying the demanding professional needs of the catering, restaurant and bakery.
- 3 Speed steel gear driven transmission.
- ¼ Horse power motor.
- 8 Quart stainless steel bowl with handle.
- Agitator moves clockwise and shaft moves counterclockwise to reach every part of the bowl.
- It mixes all the ingredients thoroughly and there is no need to rotate the bowl.
- Comes with kneading, mixing and whipping equipment.



* Safety net shown are optional.

Economy Dough Mixer

电搅面粉机

Panther

10 QT

Code	5173110
Power	600 watts
Voltage	240V/50Hz
Speed	480 rpm
	Normal 244 rpm
	Mixing 148 rpm
Max Flour Load	2.5 kg
Drum Volume	10 L
Dimension	47 x 45 x 60 cm
Weight	58 kg

15 QT

Code	5173115
Power	480 watts
Voltage	240V/50Hz
Speed	480 rpm
	Normal 244 rpm
	Mixing 148 rpm
Max Flour Load	3.5 kg
Drum Volume	15 L
Dimension	47 x 45 x 61 cm
Weight	59 kg

20 QT

Code	5173120
Power	1100 watts
Voltage	240V/50Hz
Speed	462 rpm
	Normal 317 rpm
	Mixing 197 rpm

Max Flour Load	5 kg
Drum Volume	20 L
Dimension	54 x 49 x 78 cm
Weight	83 kg



Economy Dough Mixer 经济型电搅面粉机



10 L

Code	8080310
Power	1/3 hp
Voltage	230V/50Hz
Capacity	10 L
Dough Capacity	1 kg
Speed	185, 401, 626
Dimension	43 x 43 x 66 cm
Weight	60 kg



20 L

Code	8080320
Power	1/2 hp
Voltage	230V/50Hz
Capacity	20 L
Dough Capacity	3 kg
Speed	117, 265, 494
Dimension	54 x 52 x 85 cm
Weight	90 kg



30 L

Code	8080330
Power	1 hp
Voltage	230V/50Hz
Capacity	30 L
Dough Capacity	6 kg
Speed	115, 231, 446
Dimension	43 x 43 x 66 cm
Weight	150 kg



Classic Heavy Duty Stand Mixer 重型立式混合机

KitchenAid

Code	8080400
Power	250 watts
Voltage	220-240V/50-60Hz
Capacity	4.5 qt
Dimension	35.8 x 22.1 x 35.3 cm
Weight	25 kg



Professional Heavy Duty Stand Mixer 重型立式混合机

KitchenAid

Code	8080500
Power	315 watts
Voltage	220-240V/50-60Hz
Capacity	4.8 L
Dimension	41.1 x 26.4 x 33.8 cm
Weight	12.3 kg



Professional Heavy Duty Stand Mixer (Reset Limit Switch) 重型立式混合机

KitchenAid

Code	8080600
Power	315 watts
Voltage	220-240V/50-60Hz
Capacity	4.8 L
Dimension	41.1 x 26.4 x 33.8 cm
Weight	12.3 kg

Spiral Dough Mixer with Wheel

电搅面粉机



Hercules 10

Code	8080710
Power	370 watts, 0.5 hp
Voltage	230V/50Hz
Tank Capacity	12 L
Dough Capacity	8 kg
Tank Dimension	Ø 28 x 19 cm
Speed	13 - 83 rpm
Dimension	30.5 x 58 x 56 cm
Weight	44 kg

Hercules 20

Code	8080720
Power	750 watts, 1 hp
Voltage	230V/50Hz
Tank Capacity	21 L
Dough Capacity	17 kg
Tank Dimension	ø 36 x 21 cm
Speed	10 - 85 rpm
Dimension	39 x 68 x 62.5 cm
Weight	70 kg



Hercules 30

Code	8080730
Power	1100 watts, 1.5 hp
Voltage	230V/50Hz
Tank Capacity	32 L
Dough Capacity	25 kg
Tank Dimension	ø 40 x 26 cm
Speed	10 - 85 rpm
Dimension	44 x 74 x 70 cm
Weight	95 kg

Hercules 30 TA (Tilt Head)

Code	8080731
Power	1100 watts, 1.5 hp
Voltage	230V/50Hz
Tank Capacity	32 L
Dough Capacity	25 kg
Tank Dimension	ø 40 x 26 cm
Speed	10 - 85 rpm
Dimension	44 x 82.3 x 79 cm
Weight	109 kg



Hercules 40

Code	8080740
Power	1500 watts, 3 hp
Voltage	380V/50Hz
Tank Capacity	41 L
Dough Capacity	35 kg
Tank Dimension	ø 45.2 x 26 cm
Speed	10 - 85 rpm
Dimension	49 x 91 x 82 cm
Weight	125 kg

- Made from large thickness C40 steel.
- Scratch resistant powder coating.
- Bowl with reinforced edge and AISI 304 S/S shaft.
- Forged spiral tool.
- Lid with opening to add ingredients during operation.
- High efficiency ventilated motor with oil-bath gear box.
- Thermal overload protection circuit breaker
- Reinforced chain drive.
- Low voltage IP67 protection rated controls.
- Optionals: wheels, timer and grill cover.
- On request 2 speed version.

- TA VERSION:
- Lifiable head for tank removal and easy clearing.
 - Removable container.



Rolling Machine

披萨酥皮机



Code	8080801
Power	250 watts, 0.33 hp
Voltage	230V/50Hz
Dough Weight	210/700 gr
Pizza Diameter	260/400 mm
Dimension	54 x 41 x 72 cm
Weight	37 kg

- Practical and easy-to-use pizza roller, ideal for rolling out circles of dough to prepare pizza, focaccia, bread, etc.
- It operates without heat to avoid altering the properties of the dough. The thickness and diameter of the rolled out circles can be easily adjusted based on the user's needs.
- Made of AISI 430 stainless steel.
- Lower roller scrapers are easily removable for cleaning.
- IP 54 controls with NVR.
- Pedal standard for SP 420 RP and optional for all other models.
- RP: Parallel Rollers.





Electric Cheese Grater 电动奶酪磨碎机



Code	8090315
Power	1100 watts, 1.5 hp
Voltage	230V/50Hz
Speed	1400 rpm
Dimension	31 x 44.8 x 41.2 cm
Weight	25 kg

- Made from AISI 304 Stainless steel.
- Machine strong and easy to clean.
- High efficiency ventilated motors for continuous operation.
- Large see-through plexiglass receiving tray (s/ steel optiona).
- Stainless steel drum.
- Bright finished aluminium grating mouth.
- Demountable grating mouth for a thorough cleaning. (no tools required)
- CE version: IP 67 protection rate 24V controls, Motor break, Safety microswitches on lever and receiving tray.



Electric Cheese Grater 电动奶酪磨碎机



Code	8090200
Power	380 watts, 0.5 hp
Voltage	230V/50Hz
Speed	1400 rpm
Dimension	25 x 29 x 31 cm
Weight	8 kg

- Simple and compact machines.
- Made from diecasted polished aluminium.
- Ventilated motor (only GF).
- Galvanized steel drum.



Electric Cheese Grater 电动奶酪磨碎机



Code	8091200
Power	750 watts, 1 hp
Voltage	230V/50Hz/1Ph
Speed	1400 rpm
Dimension	50 x 30 x 40 cm
Weight	20 kg

- Anodized aluminium body and ABS shockproof sides.
- Ventilated motor.
- Large bright finished aluminium grating mouth.
- Large see-through plexiglass receiving tray.
- Demountable S/S drum.

CE version:
 • 24 volt controls and NVR device.
 • Safety microswitch on the receiving tray and the lever.



Electric Cheese Grater 电动奶酪磨碎机



Code	8091400
Power	190 watts
Voltage	230V
Speed	1070 rpm
Dimension	25.4 x 16.5 x 22.8 cm
Weight	4 kg

SANSONE Pasta Machine

电动面条机



Code	8091300
Power	370 watts, 0.5 hp
Voltage	230V/50Hz
Roller Dimension	ø 60 x 320 mm
Dimension	37.5 x 60 x 54.5 cm
Weight	52 kg

- Powerful dough roller available in 4 sizes.
- Vertical construction that reduces the space taken up on the working counter and facilitates gripping of the dough at outfeed.
- Built out of stainless steel.
- Ventilated motor in non-stop operating mode with dual reduction.
- Coaxial reduction gear+ belt transmission.
- Adjustable dough thickness 0-10 mm.
- Infeed area protected with safety microswitch.
- Wide chute for dough infeed.
- Application of optional cutter available in three sizes, mm 2 - 6 - 12.
- width pasta cutter mm 165.
- Perfect also to laminate pizza.



Spare Cutter for SANSONE



2 mm

Code	8091301
Size	2 mm

6 mm

Code	8091302
Size	6 mm

12 mm

Code	8091303
Size	12 mm

Electric Pasta Machine, Single Speed

电动面条机

imperia

Code	8090622
Power	290 watts
Voltage	230V/50Hz

- All steel motorized roller machine for restaurants and professionals, produces up to 12Kg. of pasta in an hour.
- Prepares sheets of 210 mm (9 inches).
- Maximum roller opening of 5 mm (3/8 inches) has adjusting knob with ten numbered thickness settings.



Noodle Cutter

面条刀

imperia



CODE	SIZE (mm)
8090801	1.5
8090802	2.0
8090803	4.0
8090804	6.0
8090805	12.0





Manual Commercial Pasta Machine 手动面条机

imperia

Code 8090510
Dimension 30 x 22 x 25 cm

Specifications:

- Kneads 150mm sheets in 6 different thickness.
- Comes with the duplex cutter attachment for tagliatelle 2mm and fettuccine 6.5mm.
- Each machine has the fixing clamp and the handle in chrome plated steel, with hilt made of italian beech wood.



'Ipasta-La Rossa' Manual Pasta Machine 手动面条机

imperia

Code 8090400



'Titania' Manual Pasta Machine 手动面条机

imperia

Code 8090401



'Titania' Domestic Electric Pasta Machine 电动面条机

imperia

Code 8090402
Power 80 watts
Voltage 220-240V/50-60Hz

* strictly for domestic use only

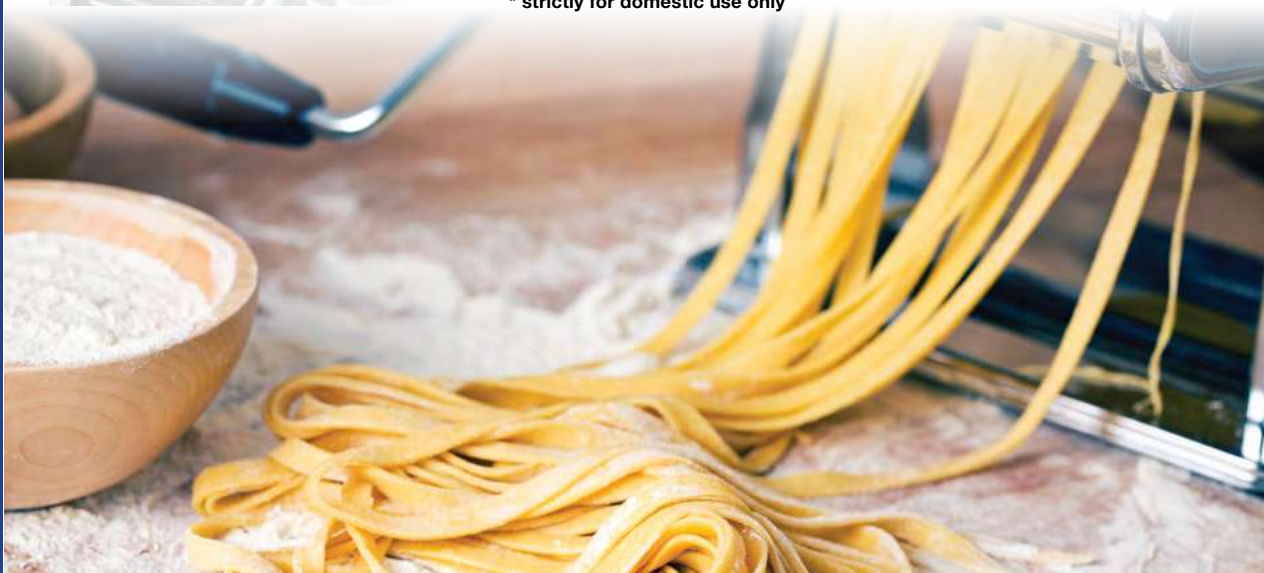

This compact ranges of table top pasta machine comes in 2 sizes of rollers; 170 or 250 mm wide sheet of pasta that can be used to make tagliatelle, lasagna, and sheets for stuffed products like ravioli and cappelletti. A powerful 750w motor runs large diameter stainless steel rollers to quickly build a sheet of pasta. Pasta sheet thickness is adjustable with a locking lever to maintain a consistent thickness. Once pasta sheets are made they can be cut down to 2mm tagliolini or 6mm fettuccine with the automatic cutting rollers built in to the back of the machine.

La Monferrina Electric Noodle Machine 电动面条机

NINA 170

Code	8090900
Power	750 watts
Roller Size	17 cm
Dimension	38 x 39 x 38 cm
Weight	36.6 kg

NINA 250

Code	8090901
Power	750 watts
Roller Size	25 cm
Dimension	45 x 39 x 38 cm
Weight	46.7 kg



Bread Slicing Machine 面包切片机



12 mm

Code	8091112
Slice	12 mm
Dimension	67 x 56 x 86 cm

14 mm

Code	8091114
Slice	14 mm
Dimension	67 x 56 x 86 cm

25 mm

Code	8091125
Slice	25 mm
Dimension	67 x 56 x 86 cm



Traditional Italian Style Meat Slicing Machine

切片机



Code	8100100
Blade	300 mm
Cut Thickness	0-3 mm
Run of carriage	285 mm
Hopper	270 x 295 mm
Weight	60 kg

Stand

Code	8100101
-------------	----------------

- 300 mm (12") blade Flywheel slicer.
- Polished and painted aluminum construction.
- Featuring stainless steel and silver anodized aluminum details.
- Patented motion system with no visible mechanical parts.
- Table featuring a lateral movement with a double articulating arm BS1 to firmly hold and smoothly slide the produce through.
- Removable carriage for ease of cleaning.
- Simple, yet stylish Italian design, rounded for ease of cleaning.
- The only one featuring a removable carriage.
- Easy to clean and disassemble without tools.



Palladio 350 Meat Slicer

电动切片机



Code	5173900
Power	400 watts, 0.54 hp
Voltage	230V, 50Hz
Blade	350 mm
Cut Thickness	23 mm
Run of carriage	285 mm
Hopper	270 x 295 mm
Dimension	66 x 57.5 x 45.5 cm
Weight	38 kg

- Rounded design, no sharp edges and visible screws.
- Chrome plated and ground slide rod.
- Self lubricating slide rod bushings.
- Vulcanized rubber stops on carriage.
- Removable support cover for thickness gauge plate.
- Stainless steel slice deflector with bayonet fitting.
- Stainless steel screws and fittings.
- Enclosed and sealed belt pulley.
- 49.5 mm distance between blade and motor.
- Bottom cover.
- Changeover electronic circuit 110-220-380 V single and three phase.
- Built in sharpening tool with bottom protection.
- Standard blade removal tool.
- 35° blade inclination.

Palladio 350 AUT Meat Slicer

电动切片机



Code	5173800
Power	370+200 watts /0.50+0.27 hp
Voltage	230V, 50Hz
Blade	350 mm
Cut Thickness	23 mm
Run of carriage	310 mm
Hopper	365 x 270 mm
Dimension	68.5 x 66 x 67 cm
Weight	40 kg

- Ergonomic controls - push buttons with IP67 protection rating.
- 3 speed selection.
- 3 different adjustments for carriage travel.
- Slice counter.
- Slice number setting with automatic stop feature.
- Enclosed and sealed drive motor.
- Positive drive belt.
- Carriage release system for manual slicing.
- Output slices per minute: 37 - 70..

**Palladio 330 Evo Meat Slicer**

电动切片机



Code	8101800
Power	275 watts, 0.37 hp
Voltage	230V, 50Hz
Blade	310 mm
Cut Thickness	23 mm
Run of carriage	285 mm
Hopper	350 x 290 mm
Dimension	63 x 66 x 62 cm
Weight	40 kg

- Special configuration of the base and slicer table to prevent chips and liquids from entering the critical devices of the machine (buttons, turn knob, etc.).
- Hi-tech tipping system and feeding pan disassembly.
- New blade pulley without centre hole to facilitate cleaning.
- Adjustable slicer table movement, guarantees higher cutting precision of thin slices.
- Safety ring on table shaft to prevent liquids from seeping inside the machine.
- Blade tilting angle: 35°.
- Buttons in insulated stainless steel (IP 67) in housing.

**Mirra 300 Meat Slicer**

电动切片机



Code	8101030
Power	210 watts, 0.29 hp
Voltage	230V, 50Hz
Blade	300 mm
Cut Thickness	13 mm
Run of carriage	265 mm
Hopper	275 x 260 mm
Dimension	54 x 74 x 46 cm
Weight	27 kg

**Mirra 250C Meat Slicer**

电动切片机



Code	8101025
Power	147 watts, 0.20 hp
Voltage	230V, 50Hz
Blade	250 mm
Cut Thickness	13 mm
Run of carriage	230 mm
Hopper	230 x 235 mm
Dimension	53.5 x 57 x 41 cm
Weight	17.5 kg

- Anodized cast aluminium alloy.
- Great distance between blade and motor for easy cleaning.
- Ventilated motor.
- Forged, hardened large thickness blades.
- Lapped sliding pins.
- Stainless steel screws and slice deflector.
- Strong thickness gauge support.
- Cast-in sharpener assembly.
- Compact dimensions but great cutting capacity.
- Device for releasing the carriage.



Mirra 250C Meat Slicer 电动切片机



Code	8101100
Power	370 watts, 0.50 hp
Voltage	230V, 50Hz
Blade	350 mm
Cut Thickness	29 mm
Run of carriage	310 mm
Hopper	300 x 270 mm
Dimension	60 x 66 x 71.5 cm
Weight	38 kg

- Innovative rounded design and no sharp edges or visible screws.
- Chrome plated ground and lapped slide rod.
- Self lubricating slide rod bushings.
- Vulcanised rubber stops on carriage.
- Removable support cover for thickness gauge plate.
- Stainless steel slice deflector with snap-on bayonet fitting.
- Stainless steel screws and fittings.
- Bottom cover for accessing electrical components.
- Changeover electronic circuit 110-220-380 V single and three-phase
- Built-in sharpening tool with bottom protection
- Enclosed and sealed belt pulley
- 48 mm distance between blade and motor
- Standard blade removal tool

Electric Meat Slicer 电切肉片机



220 mm

Code	5173622
Power	150 watts
Voltage	230V/50Hz
Blade	220 mm
Cut thickness	0 - 14 mm
Dimension	36 x 53 x 33.5 cm
Weight	13 kg

250 mm

Code	5173625
Power	180 watts
Voltage	230V/50Hz
Blade	250 mm
Cut thickness	0 - 14 mm
Dimension	40 x 55 x 37 cm
Weight	15 kg

300 mm

Code	5173630
Power	260 watts
Voltage	230V/50Hz
Blade	300 mm
Cut thickness	0 - 14 mm
Dimension	44 x 59 x 41 cm
Weight	15 kg

Meat Mincer Machine 绞肉机



TC 12E

Code	8100212
Power	735 watts, 1 hp
Voltage	230V/50Hz
Output/h	25 kg/10 min
Standard Plate	ø 4.5 mm
Dimension	21.5 x 43 x 52 cm
Weight	18 kg

TC 22E

Code	8100222
Power	800 watts, 1.2 hp
Voltage	230V/50Hz
Output/h	33 kg/10 min
Standard Plate	ø 4.5 mm
Dimension	21.5 x 44 x 52 cm
Weight	21 kg

- Made from diecasted polished aluminium.
- Ventilated motor.
- Oil-bath gear box
- Cast iron head and feeding worm.
(Aisi 304 stainless steel on demand).
- S/S plates and knives.

Meat Mincer Machine

绞肉机



TC 08 Vegas

Code	8100708
Power	250 watts, 0.34 hp
Voltage	230V/50Hz
Output/h	70 kg/h
Standard Plate	ø 6 mm
Dimension	30 x 33.5 x 41 cm
Weight	10 kg

TC 12 Denver

Code	8100612
Power	550 watts, 0.75 hp
Voltage	230V/50Hz
Output/h	85 kg/h
Standard Plate	ø 6 mm
Dimension	36.6 x 37.7 x 45.2 cm
Weight	19 kg



Meat Mincer Machine

绞肉机



Code	8101400
Power	1470 watts, 2 hp
Voltage	230V/50Hz
Output/h	300 kg/h
Standard Plate	ø 4.5 mm
Dimension	50 x 43.7 x 49 cm
Weight	32 kg

- AISI 304 stainless steel construction.
- Powerful IP 55 insulated and fan-cooled motors for continuous use.
- Endless screw motor-reducer running in an oil-bath enables a long service life.
- Motor-reducer equipped with a double seal for long, trouble-free service.
- Convenient, no-tools head lock mechanism.
- Stainless steel mincing head carefully designed for high yield production, completely removable for easy of cleaning.
- Feed tray provided with safety interlock (no. 32 CE versions).
- IP 54 protected, 24 V controls.



Mesh Plate for TC 12E
不锈钢网板 (用于TC12)

CODE	SPEC
8100320	2.0
8100330	3.0
8100345	4.5
8100360	6.0
8100380	8.0



Mesh Plate for TC 22E
不锈钢网板 (用于TC22)

CODE	SIZE
8100420	2.0
8100430	3.0
8100445	4.5
8100460	6.0
8100480	8.0



Blade for TC 12 / TC 22
不锈钢刀片 (用于TC12)

CODE	
8100512	For TC 12
8100522	For TC 22

Horizontal Cutter - Katana 6

切割机



Code	8101906
Power	370 watts - 0.5 hp
Voltage	230V/50Hz
Tank Capacity	6 L / 4.5 kg
Blades	3
Revolutions	1440 rpm
Dimension	83.2 x 51.6 x 47.2 cm
Weight	60 kg

- Completely made in AISI 304 stainless steel
- Blade driven by powerful ventilated asynchronous motor
- Sturdy, removable AISI 304 stainless steel bowl
- Easily removable interlocking lid to facilitate cleaning and sanitising
- Controls with IP 67 stainless steel buttons
- Easily removable blade hub
- Hub with 3 blades is standard.
- Maximum protection against liquid infiltration on the shaft
- Perfect for meat and vegetables, but also suitable for many other types of processing.



Horizontal Cutter - Katana 12

切割机



Code	8101912
Power	750 watts - 1 hp
Voltage	230V/50Hz
Tank Capacity	12 L / 9 kg
Blades	3
Revolutions	1440 rpm
Dimension	90.2 x 58.7 x 50.8 cm
Weight	75 kg

- Completely made in AISI 304 stainless steel
- Blade driven by powerful ventilated asynchronous motor
- Sturdy, removable AISI 304 stainless steel bowl
- Easily removable interlocking lid to facilitate cleaning and sanitising
- Controls with IP 67 stainless steel buttons
- Easily removable blade hub
- Hub with 3 blades is standard.
- Maximum protection against liquid infiltration on the shaft
- Perfect for meat and vegetables, but also suitable for many other types of processing.

Meat Mixer Machine

绞肉机



Code	8101825
Power	180 watts, 0.25 hp
Voltage	230V/50Hz
Capacity	14/10 (lt/kg)
Dimension	25.5 x 47.2 x 41 cm
Weight	18 kg

Code	8101801
Power	370 watts, 0.50 hp
Voltage	230V/50Hz
Dimension	33.0 x 55.4 x 64.6 cm
Weight	27 kg

- Practical and compact, ideal for small mixing jobs in butcher shops and restaurants.
- Made of Aisi 304 stainless steel.
 - Oil bath gear reducers with hardened and ground helical gears.
 - Gear protection system with double seal.
 - IP x5 ventilated, asynchronous motors
 - Cover with safety micro switch.
 - Aisi 304 stainless steel blade that is easily removed without tools.
 - IP54 controls with inversion.

Electric Meat Mincer

电动搅肉机

3/4 HP

Code	5173034
Power	0.75 Hp
Voltage	230V/50Hz

1/2 HP

Code	5173012
Power	0.5 Hp
Voltage	230V/50Hz

Code	5173011
Power	1 Hp
Voltage	230V/50Hz



Aries 8 Manual Sausage

灌肠机



Code	8100608
Cylinder capacity	8 L
Cylinder length	370 mm
Piston stroke	420 mm
Serie exaust funnels	ø 10-18-25 cm
Dimension	66 x 20 x 22 cm
Weight	23 kg

- AISI 304 S/S body and cylinder.
- Sturdy cylinder with double welding on the bottom plate.
- Nylon pistons with air exhaust valve.
- Galvanized steel gear box.
- Ground and tempered steel gears.
- Gears sliding on 4 sealed bearings.
- 2 speed gear reducer.
- Standard: 3 nylon filling tubes. Fixing clamp.

Electric Meat Sausage Stuffer / Filler

电动灌肠机



Code	8101700
Power	560 watts, 0.75 hp
Voltage	230V, 50Hz
Cylinder capacity	15 L
Cylinder length	495 mm
Cylinder diameter	200 mm
Piston stroke	430 mm
Serie exhaust funnels	ø 10-18-25 cm
Dimension	49 x 37 x 120 cm
Weight	53 kg

- Simple and functional, the new IDRA hydraulic vertical sausage fillers feature a powerful hydraulic system that operates at a pressure of 120 bars.



Electric Bone Saw Stainless Steel Body

电动锯骨机



Code	8101200
Motor	1.5 hp / 1400 rpm
Voltage	230V, 50Hz
Blade length	1650 mm
Working surface	430 x 545 mm
Dimension	51 x 54.5 x 91.6 cm
Weight	39 kg

- Made out of stainless steel AISI 304.
- Interlocked bone chip tray accessible from outside (not on mod. Start).
- The door can be easily removed for smoother cleaning tasks (not on mod. Start).
- Calibrated pulleys built out of polished aluminium.
- Airtight bearings on upper pulley.
- Powerful asynchronous and ventilated motors protected by sealing oil sump.
- 24V controls with safety micro-switch on door and tray, redundant ECU and motor brake (EC).
- Quick upper pulley releasing mechanism that makes it easier to clean and change the blade.
- Easily removable and replaceable scrapers.
- Powerful 6 or 8 pole motors provide great power with little absorption (S02400 and S03100)
- Single-phase motors with heat guard (standard feature).
- Can be cleaned with a water spray (no high pressure).
- Controls in stainless steel class IP 67.
- The machines use tempered 16 mm blades to shred bone, frozen or fresh.



Electric Bone Saw Aluminium Body

电动立式锯骨机



SO 1650 F3

Code	8100700
Motor	1.5 hp / 1400 rpm
Voltage	230V, 50Hz
Blade length	1650 mm
Working surface	430 x 475 mm
Dimension	60 x 53 x 91.5 cm
Weight	39 kg

SO 1840 F3

Code	8100701
Motor	1.5 hp / 1400 rpm
Voltage	230V, 50Hz
Blade length	1840 mm
Working surface	430 x 475 mm
Dimension	60 x 53 x 91.5 cm
Weight	40 kg

- Simple and sturdy machines that are safe and easy to use.
- Stand-alone structure made out of cast anodized aluminium, shiny, hygienic and rustproof.
- Features a counter, meat pusher and serving slicer in stainless steel AISI 304.
- 24V controls with safety micro-switch on door, redundant ECU and motor brake (EC).
- Utmost simplicity and accuracy when horizontally and vertically adjusting the upper pulley.
- Maximum blade adhesion to the pulley, thanks to the semi-curved shape of the pulleys and ideal adjustment.
- Airtight bearings on upper pulley.
- Smooth cleaning thanks to 2 special manufacturing details:
 - All the electrical parts are protected IP x5 or higher.
 - By simply unscrewing two knobs, you can remove the blade, upper pulley and its support, thereby making for a surface void of any encumbrance.
- Powerful asynchronous and ventilated 4-pole motors protected by sealing oil sump.
- The machines use tempered 16 mm blades to shred bone, frozen or fresh.





Heavy Duty Manual Meat Tenderizer 嫩肉器



Code	8101600
Working Surface	216 x 280 x 100 mm
Working Plate capacity	300 x 450 mm
Dimension	47.0 x 45.0 x 37.8 cm
Weight	25 kg

- Stainless steel body and details.
- Totally covered springs protected from dirt and liquids.
- Quick blade disassembling for easy cleaning.
- Mobile polyethylene cutting board.
- Sliding on tecnopolymer bushes.
- Sliding on s/s aisi 304 grinded shafts



Burger Patty Machine 汉堡小馅饼机器



BT 10		BT 13	
Code	2381410	Code	2381413
Patty Size	Ø 10 cm	Patty Size	Ø 13 cm
Dimension	16 x 22 cm	Dimension	16 x 22 cm



Paper for Burger Patty 汉堡小馅饼纸

10 cm		13 cm	
Code	8100910	Code	8100913
Size	Ø 10 cm	Size	Ø 13 cm

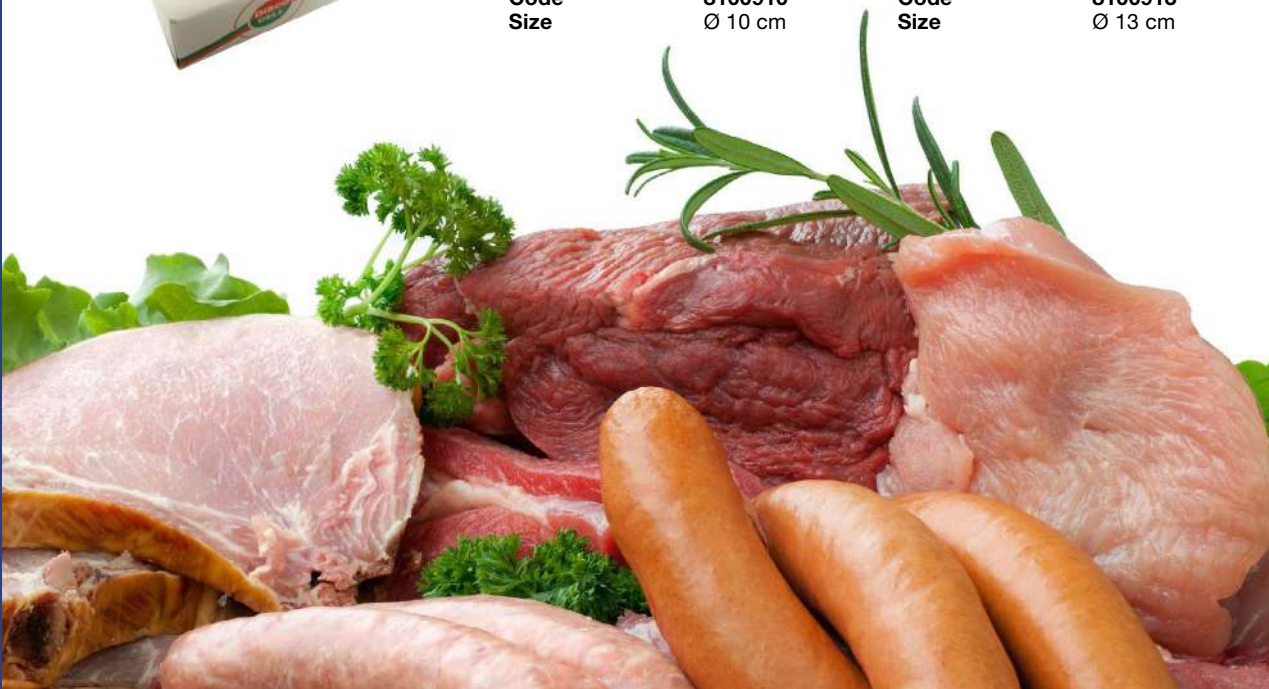

Single Electric Deep Fryer

单头电炸炉



Eldorado 5

Code	8110205
Power	2700 watts
Voltage	230V/50Hz
Tank capacity	min. 1,8 L / max. 3,2 L
Basket dimensions	22 x 12 x 10 cm
Dimension	18 x 42 x 36 cm
Weight	6 kg

Eldorado 8

Code	8110180
Power	3300 watts
Voltage	230V/50Hz
Tank capacity	min. 3 L / max. 5 L
Basket dimensions	23 x 20.5 x 10 cm
Dimension	27 x 42 x 36 cm
Weight	7 kg

- In stainless steel.
- Reinforced basket.
- Thermostat and safety cut-off probe and reset button.
- Protected resistances.
- Removable heating body and safety switch.
- Shockproof protection on resistances easily disassembled.
- Position of basket drip.
- Lid supplied.



Economy Electric Deep Fryer

电炸炉

Single 5 L

Code	8110305
Power	2800 watts
Voltage	230V/50Hz
Capacity	5.5 L
Dimension	44.7 x 28 x 27 cm
Weight	8.2 kg

Single 10 L

Code	8110310
Power	3000 watts
Voltage	230V/50Hz
Capacity	10 L
Dimension	44.7 x 28 x 31 cm
Weight	8.9 kg

Double 5 L

Code	8110402
Power	2 x 2800 watts
Voltage	230V/50Hz
Capacity	2 x 5.5 L
Dimension	44.7 x 57 x 27 cm
Weight	14.95 kg

- Designed to produce a variety of delicious crisp fried food with the minimum of fuss.
- Safe, convenient and reliable
- Hinged element box and control panel
- Removable stainless steel tank for easy cleaning.
- Night pan covers for oil tanks.
- Thermostatic temperature control maintains heat levels.
- Heavy duty stainless steel basket.
- High limit reset switch for extra safety.





Electric BBQ Garden Griller (Wide) 电烧烤炉



2 x 2000W

Code 5170704
Power 2 x 2000 watts
Voltage 220V
Dimension 37 x 55.8 cm

3 x 3000W

Code 5170706
Power 3 x 3000 watts
Voltage 220V
Dimension 55.8 x 60.9 cm

Electric BBQ Garden Griller (Long, 2-Wire) 电烧烤炉 (2条线)



U-Wire 2000W

Code 5170902
Power 2000 watts
Voltage 220V
Dimension 20.3 x 63.5 cm

U-Wire 3000W

Code 5170903
Power 3000 watts
Voltage 220V
Dimension 20.3 x 73.6 cm



Volcanic Char-Rock / Stone for Charbroiler 火山石

Code 8120304
Weight 4 kg

Electric Salamander

电烘烤箱



Salamandra PRO 1/1

Code	8120411
Power	3400 watts, 14.8 amp
Voltage	230V 50/60 Hz
Cooking compartment	585 x 350 mm
Dimension	60 x 54.5 x 51 cm
Weight	56 kg

Salamandra PRO 1/2

Code	8120412
Power	1700 watts, 7.4 amp
Voltage	230V 50/60 Hz
Cooking compartment	385 x 350 mm
Dimension	40 x 54.5 x 51 cm
Weight	45 kg

- Stainless steel body and details.
- Totally covered springs protected from dirt and liquids.
- Quick blade disassembling for easy cleaning.
- Mobile polyethylene cutting board.
- Sliding on tecnopolymer bushes.
- Sliding on s/s aisi 304 grinded shafts



Infra Red Salamander Japan

红外线烘烤箱

Rinnai

Code	8120643	Code	8120743
Power	4500 kcal/h	Power	4500 kcal/h
Type	LPG	Type	PUB
Dimension	60 x 40 x 60 cm	Dimension	60 x 40 x 60 cm

Code	8120646	Code	8120746
Power	9030 kcal/h	Power	9030 kcal/h
Type	LPG	Type	PUB
Dimension	97.8 x 40 x 60 cm	Dimension	97.8 x 40 x 60 cm

- Auto ignition with individual burner control.
- Smokeless grilling with powerful infra-red burner.
- Adjustable grilling level.
- Bench or wall mounted design.

8120643 / 8120743



8120646 / 8120746



2 Burner Griller

烧烤炉

Rinnai

Code	8120802
Dimension	44.7 x 29 x 24.2 cm
Type	LPG

- Auto ignition with individual burner control
- Rapid and efficient grilling with powerful infra-red burners
- Adjustable top grilling level
- Heat resistant protective glass top



Burner Griller 烧烤炉

Rinnai

- Auto ignition with individual burner control.
- Rapid and efficient grilling with powerful infra-red burners.
- Adjustable front grilling level.
- Heat resistant protective glass top.
- Available in lpg and town gas.



Code	8120961
Power	2100 kcal/h
Type	LPG
Dimension	60.6 x 20.9 x 21.6 cm
Weight	7.5 kg



Code	8120962
Power	4200 kcal/h
Type	LPG
Dimension	51.8 x 32.5 x 24.0 cm
Weight	12 kg



Code	7121104
Power	5500 kcal/h
Type	LPG
Dimension	58.0 x 58.0 x 30.5 cm
Weight	26.4 kg

Code	8121061
Power	2100 kcal/h
Type	PUB
Dimension	60.6 x 20.9 x 21.6 cm
Weight	7.5 kg

Code	8121062
Power	4200 kcal/h
Type	PUB
Dimension	51.8 x 32.5 x 24.0 cm
Weight	12 kg

Code	8121204
Power	5500 kcal/h
Type	PUB
Dimension	58.0 x 58.0 x 30.5 cm
Weight	26.4 kg



Code	8121106
Power	8300 kcal/h
Type	LPG
Dimension	78.0 x 58.0 x 30.5 cm
Weight	35.3 kg



Code	8121108
Power	9800 kcal/h
Type	LPG
Dimension	98.0 x 58.0 x 30.8cm
Weight	45.2 kg



Code	8121110
Power	13300 kcal/h
Type	LPG
Dimension	118.0 x 58.0 x 30.5 cm
Weight	54 kg

Code	8121206
Power	8300 kcal/h
Type	PUB
Dimension	78.0 x 58.0 x 30.5 cm
Weight	35.3 kg

Code	8121208
Power	9800 kcal/h
Type	PUB
Dimension	98.0 x 58.0 x 30.8cm
Weight	45.2 kg

Code	8121210
Power	5500 kcal/h
Type	PUB
Dimension	118.0 x 58.0 x 30.5 cm
Weight	54 kg

Electric Griller 电烤炉



Code	8121300
Power	2000 watts
Voltage	230V
Cooking Surface	400 x 245 mm
Dimension	45.0 x 35.5 x 25.5 cm
Weight	8.3 kg



- Large cooking surface
- Easy cleaning
- Enameled cast iron griddle



Electric Table Top Griddle 电平扒炉

11" Wide

Code	5171211
Power	2000 watts
Voltage	220V
Dimension	27.9 x 38.0 x 24.0 cm

16" Wide

Code	5171216
Power	2000 watts
Voltage	220V
Dimension	30.4 x 38.0 x 24.0 cm



18" Wide

Code	5171218
Power	2500 watts
Voltage	220V
Dimension	45.7 x 42.5 x 22.8 cm

20" Wide

Code	5171220
Power	3000 watts
Voltage	220V
Dimension	52.7 x 42.5 x 22.8 cm

22" Wide

Code	5171222
Power	2 x 2500 watts
Voltage	220V
Dimension	55.8 x 42.5 x 22.8 cm

24" Wide

Code	5171224
Power	2 x 3000 watts
Voltage	220V
Dimension	60.9 x 45.7 x 22.8 cm

21" Table Top Griddle with 1 Side Groove 电平扒炉

Code	5171321
Power	3000 watts
Voltage	220V
Cooking Surface	400 x 245 mm
Dimension	55.8 x 42 x 22.8 cm



TOP L Electric Sandwich Grill 电烤炉



Code	8123000
Power	1800 watts
Voltage	230V 50/60 Hz
Cooking compartment	50 x 25.5 cm
Dimension	51.5 x 43.5 x 17 cm
Weight	18 kg

- Long life cast iron plates, which ensure hygiene, acid and salt proofness and resistance to oxidation.
- Ribbed, smooth or mixed ribbed/smooth cast iron or smooth stainless steel surfaces available.
- Stainless steel construction.
- Cast iron plates with ceramic coating treatment:
Highest sturdiness and life time;
Perfect thermal conductivity;
Very easy to clean.
- Self balancing adjustable upper plates.
- Shock-proof coated heating elements, adherent to the plates for a perfect thermal conductivity.
- Two adjustable thermostats up to 300° C, which enable to use the plates separately.
- Heavy-duty machine.
- Mechanical timer available.

Cast Iron Electric Panini Contact Grill 电烤炉



Power	1550 watts
Voltage	230V 50/60 Hz
Cooking	25 x 25.5 cm
Dimension	26.0 x 43.5 x 23.5 cm
Weight	16 kg

Elio LR

Code 8122100

Elio RR

Code 8122102

- Thanks to its small size, it is easy to handle and to position, offering as well a large cooking surface.
- Ribbed and smooth surfaces available.
- Stainless steel construction.
- Cast iron plates with ceramic coating treatment:
highest sturdiness and life time;
perfect thermal conductivity;
very easy to clean.
- Adjustable upper plates.
- Self balancing upper plate.
- Shock-proof coated heating elements, adherent to the plates for a perfect thermal conductivity.
- Adjustable thermostat up to 300° C.
- Mechanical timer available.

Cast Iron Electric Panini Contact Grill 电烤炉



Power	2100 watts
Voltage	230V 50/60 Hz
Cooking compartment	35.5 x 25.5 cm
Dimension	38.0 x 43.5 x 23.5 cm
Weight	22 kg

Cort LR

Code 8122200

Cort RR

Code 8122202



- Thanks to its small size, it is easy to handle and to position, offering as well a large cooking surface.
- Ribbed and smooth surfaces available.
- Stainless steel construction.
- Cast iron plates with ceramic coating treatment:
highest sturdiness and life time;
perfect thermal conductivity;
very easy to clean.
- Adjustable upper plates;
- Self balancing upper plate;
- Shock-proof coated heating elements, adherent to the plates for a perfect thermal conductivity.
- Adjustable thermostat up to 300° C.
- Mechanical timer available.
- Only PS models: cast iron plates removable for cleaning.

Cast Iron Electric Contact Grill

电烤炉



Power	3000 watts
Voltage	230V 50/60 Hz
Cooking compartment	50 x 25.5 mm
Dimension	51.5 x 43.5 x 23.5 cm
Weight	28 kg

PD LR

Code 8122801

PD RR

Code 8122802

- Long life cast iron plates, which ensure hygiene, acid and salt proofness and resistance to oxidation.
- Ribbed, smooth or mixed ribbed/smooth cast iron or smooth stainless steel surfaces available.
- Stainless steel construction.
- Cast iron plates with ceramic coating treatment.
- Highest sturdiness and life time. Perfect thermal conductivity. Very easy to clean.
- Self balancing adjustable upper plates;
- Shock-proof coated heating elements, adherent to the plates for a perfect thermal conductivity.
- Two adjustable thermostats up to 300° C, which enable to use the plates sepa-rately.
- Heavy-duty machine.
- Mechanical timer available.
- Only PS models: cast iron plates removable for cleaning.



SURFACE FINISH



PD RR



PD LR



SURFACE FINISH

Vitro Ceramic Electric Panini Contact Grill

电烤炉



Power	3000 watts
Voltage	230V 50/60 Hz
Cooking compartment	34 x 29 cm
Dimension	43.5 x 49.0 x 17.0 cm
Weight	14 kg

Cort-V LR

Code 8122300

Cort-V RR

Code 8122302

Cort-V LL

Code 8122303

- Stainless steel construction.
- Ceran® ceramic-glass cooking surfaces.
- Thermostat control.
- Useful drip tray for liquids and other cooking leavings.
- Easy to clean.
- Self balancing adjustable upper plates.
- Adjustable feet for a safe and steady placing.
- Ideal for a fast achievement of working temperature.



SURFACE FINISH



CORT V RR



SURFACE FINISH

CORT V LL



SURFACE FINISH

CORT V LR



SURFACE FINISH

PD V LR



SURFACE FINISH

PD V RR

Vetro Ceramic Electric Contact Grill

电烤炉



Power	3000 watts
Voltage	230V 50/60 Hz
Cooking compartment	2 x (260x290) mm
Dimension	70.0 x 49.0 x 17.0 cm
Weight	22 kg

PD V LR

Code	8122900
-------------	----------------

PD V RR

Code	8122902
-------------	----------------

- Stainless steel construction.
- Ceran® ceramic-glass cooking surfaces.
- Thermostat control.
- Useful drip tray for liquids and other cooking leavings.
- Easy to clean.
- Self balancing adjustable upper plates.
- Adjustable feet for a safe and steady placing.
- Ideal for a fast achievement of working temperature.



EU3



EU4

Electric Doner Grill Machine

电烤肉机



EU3

Code	8122700
Power	5400 watts
Voltage	400/50Hz, 230V for rotating shaft
Skewer	736 mm
Meat capacity	50 kg
Max. Meat Mountage Height	450 mm
Dimension	78 x 53 x 65 cm
Weight	28 kg

EU4

Code	8122701
Power	7200 watts
Voltage	400/50Hz, 230V for rotating shaft
Skewer	900 mm
Meat capacity	90 kg
Max. Meat Mountage Height	450 mm
Dimension	107 x 53 x 65 cm
Weight	34 kg

- Stainless steel construction to meet hygiene standards
- Heated by independently controlled heating elements behind ceramic glass
- Movable heater housing for controlled roasting
- Right/left rotation by electric motor 1 rpm
- Heating system under the monoblock grease pan for keeping cooked meat at serving temperatures



Electric Doner Slicing Machine

电切肉机



Code	8122702
Power	100 watts
Voltage	220 V
Knife Diameter	10 cm
Machine Handle	900 gr
Circling	4500 rpm
Dimension	29 x 13 x 14 cm
Weight	4 kg

Electric Crepe Maker, Standard Range

电动薄皮饼机



Code	8130100
Power	3000 watts
Voltage	230 V
Griddles	Ø 40 cm
Dimension	43.0 x 47.0 x 17.5 cm
Weight	19 kg
Surface Type	Cast Iron

- Stainless steel frame
- Cast iron griddle, machined approved for contact with food
- On/off switch
- Power indicator light
- Heating indicator light
- EC power supply lead for 230V ~ 16-amp socket or 3-phase 400V ~ 20-amp socket



Electric Crepe Maker, 6000 Range

电动薄皮饼机



Code	8130200
Power	3000 watts
Voltage	230 V
Griddles	Ø 40 cm
Dimension	43.0 x 47.0 x 17.5 cm
Weight	12 kg
Surface Type	Enamelled

- Griddle ø 40 cm
- Enamelled cast steel griddle approved for contact with food
- Adjustable thermostat
- Indicator to signal heating



Electric Crepe Maker, Standard Range

电动薄皮饼机



CEBIV3

Code	8130201
Power	2500 watts
Voltage	230 V
Griddles	Ø 35 cm
Dimension	Ø 35 x 12.5 cm
Weight	12 kg
Surface Type	Cast Iron

CEBIV4

Code	8130202
Power	3000 watts
Voltage	230 V
Griddles	Ø 40 cm
Dimension	Ø 40 x 12.5 cm
Weight	16 kg
Surface Type	Cast Iron

- Stainless steel frame
- Cast iron griddle, machined approved for contact with food
- On/off switch
- Power indicator light
- Heating indicator light



Gas Crepe Maker Luxury Range 薄皮饼机



Code	8130203
Power	7000 watts
Control	Thermostatic
Griddles	Ø 40 cm
Dimension	Ø 40 x 19 cm
Weight	16 kg

- Stainless steel frame
- Cast steel griddle, machined, approved for contact with food
- Piezoelectric ignition
- Safety system in case of interruption of the flame
- Supply by butane, propane or natural gas

Electric Waffle Iron Maker



- Stainless steel frame
- Cast steel irons approved for contact with food
- Drip tray for waste recovery
- Protected controls
- On/off switch built into the control button
- Power light
- Thermostatic control from 50°C to 300°C
- Heat insulation of the element
- Heating indicator
- EC power supply lead for 240V ~ 16-amp socket

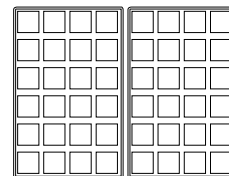
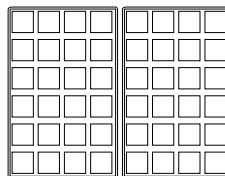
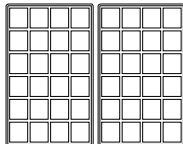

4'' x 6'' Liège 90°

Code	8130300
Power	1400 watts
Voltage	240V
No. of Waffle	2
Dimension	26.0 x 31.5 x 22.0 cm
Weight	16 kg
Opening	90°

4'' x 6'' Bruxelles 90°

Code	8130301
Power	1800 watts
Voltage	240V
No. of Waffle	2
Dimension	26.0 x 31.5 x 22.0 cm
Weight	19 kg
Opening	90°

4'' x 6'' Bruxelles 180°

Code	8130302
Power	1800 watts
Voltage	240V
No. of Waffle	2
Dimension	26.0 x 44.0 x 22.0 cm
Weight	20 kg
Opening	180°

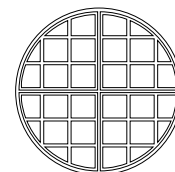
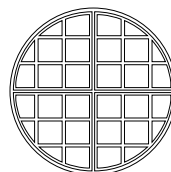
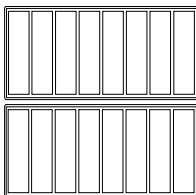

Churros 180°

Code	8130303
Power	1800 watts
Voltage	240V
No. of Waffle	16
Dimension	26.0 x 44.0 x 22.0 cm
Weight	20 kg
Opening	180°

Ronde 180°

Code	8130400
Power	1800 watts
Voltage	240V
No. of Waffle	4
Dimension	26.0 x 34.5 x 22.0 cm
Weight	23 kg
Opening	180°

Ronde 90°

Code	8130401
Power	1800 watts
Voltage	240V
No. of Waffle	4
Dimension	26.0 x 50.0 x 22.0 cm
Weight	24 kg
Opening	90°

Electric Thin Waffle Maker

瓦夫卢

Single

Code	8140800
Power	1,040 watts
Voltage	230V / 50Hz
Dimension	50 x 23 x 20 CM
Weight	8.1 kg

Double

Code	8140801
Power	2,080 watts
Voltage	230V / 50Hz
Dimension	51 x 39 x 23 CM
Weight	15 kg

- Flexibility and economy - plates can be independently operated
- Timer control for the pre-setting cooking time periods
- Stainless steel finish body, hygienic and easy cleaning
- Grids produce standard thickness and round sized waffles consistently



Electric Sandwich Contact Toaster

烤面包机

Dualit.

Code	8140901
Power	1,600 watts
Voltage	230V
Product Output	60 per hour
Dimension	40 x 22 x 19 cm
Weight	6.0 kg



Deep filled and very filling

Dualit's contact toaster makes delicious, sealed toasted sandwich triangles; their deep moulding and robust seal means that fillings can be extremely generous. The two hotplates can be operated individually to conserve energy.

Electric Topping Sauce Warmer

电汁保温机

Krampouz

BECIC-1A0

Code	8141001
Power	185 watts
Voltage	220 - 240V
Pot Diameter	9 CM
Dimension	22 x 16 x 20 CM
Weight	2.5 kg

BECIC-2A0

Code	8141002
Power	370 watts
Voltage	220 - 240V
Pot Diameter	9 CM
Dimension	22 x 27 x 20 CM
Weight	3.8 kg

BECIC-3A0

Code	8141003
Power	560 watts
Voltage	220 - 240V
Pot Diameter	9 CM
Dimension	22 x 40 x 20 CM
Weight	5.1 kg



Krampouz topping warmer keeps toppings warm for easier crepes, waffles, ice cream coating.

Electric Hotdog & Bread Warmer

电烤炉



Code	8140704
Power	600 watts
Voltage	230V / 50-60Hz
Bread Warmer Port	4
Basket Size (Ø x h)	15.2 x 19.4 cm
Basket Capacity	Est 30 Hotdogs
Dimension	45 x 32 x 36.5 cm
Weight	11.5 kg

- Pyrex container for steaming hot dogs.
- Stainless steel basket for hot dogs.
- Heating up controlled by a symostat.
- Sealed electric components protected against leaks.
- Anodized aluminium bun warmers.

Electric Hotdog Roller Grill

电香肠烧烤机



5 Rollers

Code	8140405
Power	430 watts
Voltage	230V / 50Hz
Dimension	58 x 22.5 x 22.5 cm

7 Rollers

Code	8140407
Power	590 watts
Voltage	230V / 50Hz
Dimension	58 x 30.5 x 22.5 cm

9 Rollers

Code	8140409
Power	750 watts
Voltage	230V / 50Hz
Dimension	58 x 38.5 x 22.5 cm

Spare Polycarbonate Cover For Hotdog Grill

8140505	For 5 Rollers Model
8140507	For 7 Rollers Model
8140509	For 9 Rollers Model



Electric Conveyor Bread Toaster

电烤炉



TM-5H

Code	8150105
Power	1,340 watts
Voltage	230-240V / 50-60Hz / single phase
Product Output	180 Slices per Hour
Dimension (w x d x h)	28.9 x 41.6 x 37.8 cm
Weight	14 kg

TM-10H

Code	8150110
Power	1,900 watts
Voltage	230-240V / 50-60Hz / single phase
Product Output	360 Slices per Hour
Dimension (w x d x h)	36.8 x 41.6 x 37.8 cm
Weight	17 kg

All the features of a high-end toaster with a low-end price. The Hatco Toast-Max economy conveyor toaster offers the flexibility and performance to perfectly toast bread and buns fast. Utilizing conveyor speed, not temperature, to determine toasting colour, allows for instant adjustment of toasting time.

- 4 position toast selector switch: off/toast/buns/standby mode.
- 89 mm clearance to accommodate high profile bread products.
- Easy-to-load rack with front or rear discharging.
- V-shaped reflectors help capture and redirect heat.
- Long lasting serpentine metal sheathed heating elements.
- 102 mm adjustable legs
- Pilot light that signals unit is in operation.
- Discharge & crumb trays are removable.

Electric Conveyor Bread Toaster 电烤炉



TM3-10H

Code	8150810-XX
Power	1,920-2,285 watts
Voltage	220-240V / 50-60Hz / single phase
Product Output	290-350 Slices per Hour
Dimension (w x d x h)	33.8 x 46.4 x 41.1 cm
Colours Available	■ BK ■ RD

When ordering , add colour CODE suffix to item code. (eg: 8150310-BK)

- ColorGuard Sensing System monitors and adjusts conveyor speed during peak periods to ensure toast color uniformity.
- Power Save mode with indicator light activates automatically after a certain period of time, saving energy during off-peak periods.

Electric Conveyor Bread Toaster 电烤炉



TQ-400H

Code	8150240
Power	2,210 watts
Voltage	230-240V / 50-60Hz / single phase
Product Output	360 Slices per Hour
Dimension (w x d x h)	36.8 x 45.1 x 40.3 cm
Weight	21 kg

TQ-800H

Code	8150280
Power	3,593 watts / 15 Amp
Voltage	240V / 50-60Hz / single phase
Product Output	840 Slices per Hour
Dimension (w x d x h)	36.8 x 57.8 x 42.2 cm
Weight	28 kg

TOAST-QWIK

COLORGUARD SENSING SYSTEM

Exclusive, patent-pending compensating system monitors cabinet temperature and adjusts conveyor speed during high usage periods to assure uniform toast.

STATE-OF-THE-ART ELECTRONIC CONTROLS

Precisely regulate both top and bottom heating elements for perfect golden toasting every time.

POWER SAVE MODE WITH INDICATOR LIGHT

Saves energy and money during slow periods



Original Classic Toaster

The original Dualit toaster, in four different sizes to suit a variety of needs, incorporates our trademark mechanical timer and ejector lever, with the ability to select only the slots you need to use. New Gen models offer additional defrost and bagel functions and the 6 slice workhorse can produce a staggering 130 rounds of toast every hour.

Features

- Built for commercial use
- Selector control for heating one, two, three or all four slots
- Setting to defrost frozen bread before toasting
- Selector control for toasting buns/bagels (toasting one side and warming the other)
- Award-winning ProHeat elements, guaranteed for two years
- Handmade in the UK
- Mechanical timer
- Manually operated eject lever to keep items warm until needed
- High lift mechanism to remove small items easily
- Replaceable parts (you don't throw a Dualit toaster away, we repair it for you!)
- Adjustable rear foot to compensate for uneven surfaces
- Removable crumb tray
- Extra-wide 28mm slots and adjustable inner wire guard to accommodate a sandwich cage
- Materials: Cast Aluminium ends, stainless steel body

Dualit.



8150302-RD



8150302-BK

Classic Slot Toaster, 2 Slots

烤面包机 (2片)

Dualit.

Code	8150302-XX
Power	1,200 watts
Voltage	230-240V
Product Output	65 slice per hour
Number of Slots	2
Slot Width	2.8cm
Dimension (l x d x h)	26 x 21 x 22 cm
Weight	3.5 kg
Available Color	■ RD ■ BK



8150304-RD



8150304-PO

Classic Slot Toaster, 4 Slots

烤面包机 (4片)

Dualit.

Code	8150304-XX
Power	2,200 watts
Voltage	230-240V
Product Output	130 slice per hour
Number of Slots	4
Slot Width	2.8cm
Dimension (l x d x h)	36 x 21 x 22 cm
Weight	4.25 kg
Available Color	■ RD ■ BK ■ PO



8150304-BK



8150306-PO

Classic Slot Toaster, 6 Slots

烤面包机 (6片)

Dualit.

Code	8150306-XX
Power	3,000 watts
Voltage	230-240V
Product Output	240 slice per hour
Number of Slots	6
Slot Width	2.8cm
Dimension (l x d x h)	46 x 21 x 22 cm
Weight	5.1 kg
Available Color	■ RD ■ BK ■ PO



8150306-BK



8150306-RD

Cool and calm in every respect

HUGENTOBLER
Swiss cooking systems®

Quality-enhancing warming

Beat the peaks in your workday – keep quick-roast food and fried dishes in the Hold-o-mat until serving. The meal components are integrated directly into the prepared menus and served in succession. From now on, you can simply send out the tables stress-free – that's quality of life!



Cook & hold

Gentle low-temperature cooking with non-circulating heat – leave it to the Hold-o-mat and free up your combi-steamer for other jobs. Meat is cooked and kept warm with 10 % – 20 % less weight loss in the Hold-o-mat. This not only increases the tenderness of the meat but also has a positive effect on your profitability.



In the heat of the night

Simple overnight cooking – while you're enjoying a restful night's sleep, the Hold-o-mat cooks the next day's menu for you! Low-temperature cooking 'overnight' in the Hold-o-mat ensure that meat sauce-based dishes are tender and juicy, makes use of cheaper nighttime electricity rates and lowers your overall bill.



Portable – suitable for parties and outside catering

Food pre-prepared in the kitchen can be transported in the Hold-o-mat and served warm. From the Hold-o-mat direct to guests. The folding handles ensure optimum comfort from the kitchen to the delivery station.



Technical data:

- Precise temperature control thanks to the PT 500 system and its ingenious software
- Intelligent dehumidification system guarantees optimum warming conditions
- Can be built into all ranges and kitchen furniture
- Door hinging can be adjusted to open to left or right



Hold-O-Mat 411

Code	8150601
Power	1500 watts
Voltage	230V / 50/60Hz
Capacity	4 x 1/1 65mm / 2 x 1/1 100 mm
Weight	28 kg



Hold-O-Mat Standard

Code	8150602
Power	1000 watts
Voltage	230V / 50/60Hz
Capacity	3 x 1/1 65mm / 2 x 1/1 100 mm
Weight	24 kg

**ready for core temperature probe

Code	8150603
	Standard

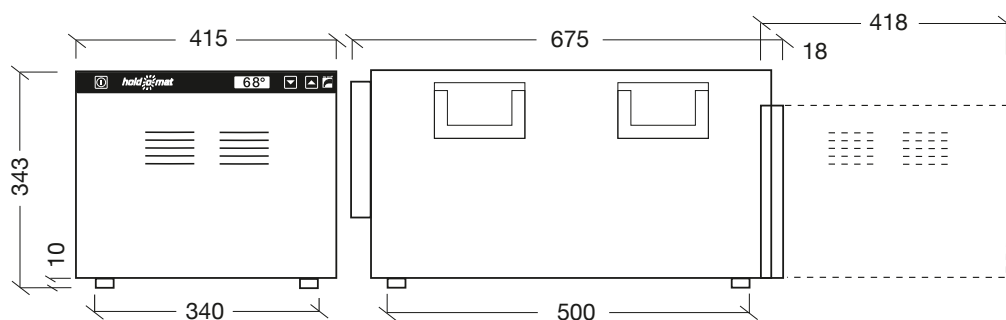

Electric Sandwich Toaster, 1 Tier 电烤炉



8150506

Code	8150506
Power	2,800 watts
Voltage	230V / 50Hz
Product Output	6-Toast per time
Number of Tiers	1
Int Toast Dimension (l x d)	35.5 x 24 cm
Dimension (l x d x h)	47.5 x 26.5 x 24 cm
Weight	7.5 kg



Remark Complete with 1-pcs Full Size Grate

Electric Sandwich Toaster, 2 Tier 电烤炉



8150512

Code	8150513
Power	3,000 watts
Voltage	230V / 50Hz
Product Output	12-Toast per time
Number of Tiers	2
Int Toast Dimension (l x d)	35.5 x 24 cm
Dimension (l x d x h)	47.5 x 26.5 x 36.5 cm
Weight	9 kg



Remark Complete with 1-pcs Full Size Grate

- Ideal for heating up pizzas, sandwiches and ready-cooked foods, for cooking hamburgers, wüstels and rolls.
- Stainless steel construction.
- Easy to clean grills.
- Removable drip tray.
- Chromium-plated steel pincers.
- Elements with quartz tubes.
- 15 minutes timer.

Electric Convection Oven, ALISEO 2/3 电烤炉



8160100

Code	8160100
Power	2,600 watts
Voltage	230V / 50Hz
Temperature Range	25 - 300 °C
Number of Shelves	4
Fit Tray Size	44 x 33cm
Int Toast Dimension (l x d x h)	48 x 36 x 30 cm
Dimension (l x d x h)	60 x 62.5 x 51.5 cm
Weight	35 kg

Electric Convection Oven, ALISEO 2/3 with Grill

Code	8160101
Power	2,600 - 2,800 watts
Voltage	230V / 50Hz
Temperature Range	25 - 300 °C
Number of Shelves	4
Fit Tray Size	44 x 33cm
Int Toast Dimension (l x d x h)	48 x 36 x 30 cm
Dimension (l x d x h)	60 x 62.5 x 51.5 cm
Weight	35 kg



8160102

Electric Convection Oven, ALISEO 4 电烤炉



- Stainless steel construction including chamber.
- Distance between shelves cm 8.
- Seamless, round-cornered and easy to clean chamber to prevent contamination.
- Double glass stainless steel door.
- Effective 2 lamp chamber lighting.
- Thermostatically controlled temperature from 25°C to 300°C (77°F to 572°F).
- Choice of 0' to 120' programmable timer or continuous operation.

Code	8160102
Power	3,400 watts / 15 Amp
Voltage	230V / 50Hz / single phase
Temperature Range	25 - 300°C
Number of Shelves	4
Fit Tray Size	GN 1/1 Size / 40x60cm
Int Toast Dimension (l x d x h)	65 x 46 x 36 cm
Dimension (l x d x h)	82 x 76 x 61 cm
Weight	54 kg

Electric Pizza Oven, 1 Tier

电比萨烤箱



Code	8160601
Power	1,600 watts
Voltage	230V / 50Hz / single phase
Temperature Range	50 - 350°C
Timer	30 mins
No. of Pizza	2 pcs of 22cm Pizza
Int Toast Dimension (l x d x h)	41 x 36 x 8 cm
Dimension (l x d x h)	58 x 49 x 24.5 cm
Weight	25 kg



8160601

Electric Pizza Oven, 2 Tier

电比萨烤箱



Code	8160602
Power	3,200 watts / 15 Amp
Voltage	230V / 50Hz / single phase
Temperature Range	50 - 350°C
Timer	30 mins
No. of Pizza	2 pcs of 22cm Pizza X 2 Tier
Int Toast Dimension (l x d x h)	41 x 36 x 8 cm X 2 Tier
Dimension (l x d x h)	58 x 49 x 42 cm
Weight	37 kg



8160602

- Stainless steel construction
- Refractory brick deck
- Shock-proof heating elements
- Air-hole
- Capacity to 1 level:

Electric Pizza Oven, VESUVIO

电比萨烤箱



Code	8162000
Power	5,100 watts
Voltage	400V / 50Hz / 3 phase
Temperature Range	0 - 350°C
Timer	30 mins
No. of Pizza	2 pcs of 41cm Pizza OR 4 pcs of 35cm Pizza
Int Toast Dimension (l x d x h)	70 x 70 x 14.9 cm
Dimension (l x d x h)	99.5 x 103.8 x 56.6 cm
Weight	80 kg



- S/steel construction.
- Stainless steel door with double glass window.
- It is possible to check the temperature inside the chamber by means of a thermometer.
- Temperature inside the chamber is controlled by a general thermostat.
- Heating of the upper and lower elements is adjustable by means of 2 separate symostats.
- Double interior lighting.
- Refractory brick deck.
- Fumes and vapour chimney.



Electric Commercial Microwave Oven 微波炉

MENUMASTER®
Commercial



DEC14E2

Code	8161014
Power Output	1,400 watts
Power Consumption	2,300 watts / 10 Amp
Frequency	2,450 Mhz
Voltage	230V / 50Hz / single phase
Cavity Space	17-Ltrs
Int Toast Dimension (l x d x h)	33 x 30.5 x 17.1 cm
Dimension (l x d x h)	42.5 x 57.8 x 34.3 cm
Weight	30 kg

DEC18E2

Code	8161018
Power Output	1,800 watts
Power Consumption	2,900 watts / 12.6 Amp
Frequency	2,450 Mhz
Voltage	230V / 50Hz / single phase
Cavity Space	17-Ltrs
Int Toast Dimension (l x d x h)	33 x 30.5 x 17.1 cm
Dimension (l x d x h)	42.5 x 57.8 x 34.3 cm
Weight	30 kg

The Menumaster line of heavy-duty compact ovens offer powerful heating performance in a space-saving design. Durable and stackable, this oven is ideal for hard-use, high-volume operations. The unique method of energy distribution provides superior even-heating, so your customers will notice your food, not your foods' temperature.

Key Features

- 1400 or 1800 Watts of power available for Selection for fast heating.
- Ample 17 liter capacity easily accommodates a standard half-pan.
- Up to 100 programmable menu items simplifies cooking and ensures consistent results.
- Four Stage Cooking Option for one-touch cooking. Reduces prep time, labor and food waste while providing consistent results.
- 11 power levels for consistent, delicious results for frozen and fresh foods. Food can go from freezer to table in minutes.
- Unique method of energy distribution provides superior even-heating.
- User-friendly controls are easy to use and require minimal user training.
- Space-saving stackable design.
- Interior ceramic shelf is sealed and recessed to help reduce plate to shelf edge impact and keep spills contained.
- Interlock switch assembly is engineered for maximum durability and long life.
- X2 Multiple quantity pad calculates the proper cook times for multiple portions.
- Durable stainless steel exterior and interior for years of commercial foodservice use.



Electric Commercial Microwave Oven, RCS511TS 微波炉

MENUMASTER®
Commercial

Code	8161910
Power Output	1,100 watts
Power Consumption	1,550 watts
Frequency	2,450 Mhz
Voltage	230V / 50Hz / single phase
Cavity Space	34-Ltrs
Int Toast Dimension (l x d x h)	36.8 x 38.1 x 21.6 cm
Dimension (l x d x h)	55.8 x 48.26 x 34.9 cm
Weight	18.6 kg

- Up to 100 programmable menu items simplifies cooking and ensures consistent results.
- Four stage cooking option for easy one-touch cooking.
- Multiple quantity pad calculates the proper cooking times for multiple portions.
- User friendly touch controls are easy to use.
- Time entry option for added flexibility.
- Digital display with countdown timer for simple operation and "at-a-glance" monitoring.
- Braille touch pads.
- See-through door and lighted interior for monitoring without opening the door.
- 34 Liter (1.2 cubic ft.) capacity accommodates a 356 mm (14") platter, prepackaged foods and single servings.
- Stackable to save valuable counter space.

Electric Domestic Microwave Oven, R299T

微波炉

Code	8161223
Power Output	800 watts
Voltage	230-240V / 50Hz
Cavity Space	22-Ltrs, 27.2cm Turntable
Dimension (l x d x h)	46 x 36 x 27.5 cm
Weight	12 kg

Features:

- New Express Defrost Key with 3 Menus
- Powerful Output Power (800 W) for Quick and Efficient Cooking
- Wide 272 mm Turntable
- Compact and Space-saving Design
- 3 Auto Menu Keys
- 2 Reheat Menu Keys
- Instant Cook
- Easy Defrost
- More/Less Setting
- Slow Cook Key
- Child Lock



Electric Domestic Microwave Oven, R369T

微波炉

Code	8161233
Power Output	1,100 watts
Voltage	230-240V / 50Hz
Cavity Space	33-Ltrs, 32cm Turntable
Dimension (l x d x h)	52 x 44.8 x 31 cm
Weight	17 kg

Features:

- New Express Defrost Key with 3 Menus
- 6 Microwave Power Levels
- 2 Reheat Menu Keys
- Easy Defrost
- Slow Cook Key
- Child Lock
- Alarm Function



Electric Auto Nigiri Sushi Machine

电动寿司机

Code	8170901
Power Output	80 watts
Voltage	230V/50Hz
Production capacity	Up to 2,400 pcs / hr
Nigiri Size	18-24g/ball
Dimension (l x d x h)	31 x 51.3 x 63.6 cm
Weight	23 kg

- Compact and high performance with flexible operation
- Flexible operation: Continuous forming mode or single forming mode can be selected easily.
- Improved quality formation of rice balls-producing consistent rice balls with less rough edges.
- Compact body and simple structure: Easy to clean with fewer parts and no complicated adjustment.



Electric Auto Norimaki Sushi Roll Machine

电动寿司卷机

Code	8170902
Power Output	70 watts
Voltage	230V/50Hz
Rice Capacity	7.5kg
Production capacity	7 sec/rice sheet, 5 sec/roll
Dimension (l x d x h)	39.2 x 59.1 x 69.9 cm
Weight	48 kg

- The lighter machine parts simplify daily cleaning, assembling and disassembling.
- The new feature of loosening rice was designed for the ASM880 and the hopper capacity was increased to 10kg.
- The machine keeps the setting values of the previous operation. These can be recalled automatically just by attaching each wrapping unit to the main body.
- Its applicability to long rolls makes it possible to make various kinds of rolled sushi. Inside-out rolls can also be made by changing settings.
- Changing the wrapping unit is easy with a one-touch simple operation and the previously used rice mat setting is automatically set in accordance with the size of the wrapping unit.



Automatic Gas Rice Cooker, LPG 煤气饭锅

Rinnai



LPG

Code	5172355
Power (LPG kw / kg/h)	7.98 / 0.57
Gas Connection	LPG 9.5
Ignition Type	Piezo Pilot
Dimension	54 x 41.5 x 48.5 cm
Weight	16.2 kg

TG

Code	5172455
Power (LPG kw / kg/h)	8,196
Gas Connection	TG13
Ignition Type	Piezo Pilot
Dimension	54 x 41.5 x 48.5 cm
Weight	16.2 kg

- Capacity to cook up to 8Kg of rice in 25 minutes
- One-touch automatic ignition system
- Automatic shut-off device
- Enamel finishing for easy cleaning

Electric Rice Cooker 电饭锅



4.2 L

Code	5172042
Power Output	1550 watts
Voltage	230-240V / 50Hz
Rice Capacity	4.2 L
Dimension	43 x 37 x 33 cm
Weight	5.5 kg

5.6 L

Code	5172056
Power Output	1950 watts
Voltage	230-240V / 50Hz
Rice Capacity	5.6 L
Dimension	47 x 40 x 36 cm
Weight	7.5 kg

7.8 L

Code	5172078
Power Output	2650 watts
Voltage	230-240V / 50Hz
Rice Capacity	7.8 L
Dimension	53 x 46 x 38 cm
Weight	11 kg

10 L

Code	5172098
Power Output	2950 watts
Voltage	230-240V / 50Hz
Rice Capacity	10 L
Dimension	58 x 49 x 42 cm
Weight	13 kg

Electric Rice Cooker 电饭锅

Panasonic



4.2 L

Code	8170142
Power Output	1,400 watts
Voltage	230-240V / 50Hz
Keep Warm Temperature	approx. 80 °C
Rice Capacity	4.2 L
Dimension	42.9 x 36.9 x 30 cm
Weight	5.5 kg

7.2 L

Code	8170172
Power Output	2,500 watts
Voltage	230-240V / 50Hz
Keep Warm Temperature	approx. 80 °C
Rice Capacity	7.2 L
Dimension	59.7 x 47 x 35.6 cm
Weight	11 kg

- Automatic cooking of rice
- Ideal for Restaurants and Large families
- Keep warm function - up to 5 hours
- Anodized aluminum cooking pan
- Big and smooth surface of cast heater conducts heat efficiently
- Thermostat for precision control
- Thermal fuse to protect unit from burn out
- Included accessories: rice scoop and measuring cup

Electric Rice Cooker 电饭锅

 **SunWare**



5.4 L

Code	8170254
Power Output	1,650 watts
Voltage	220V / 50Hz
Rice Capacity	5.4 L
Dimension	43 x 43 x 32 cm
Weight	7.4 kg

10 L

Code	5172210
Power Output	3,200 watts
Voltage	230-240V / 50Hz
Rice Capacity	10 L
Dimension	58 x 57 x 38 cm
Weight	13 kg

Electric Rice Cooker, Flip Lid 电饭锅



Code	5172106
Power Output	1,650 watts
Voltage	230-240V / 50Hz
Rice Capacity	6 L
Dimension	42.6 x 42.6 x 39.8 cm
Weight	10 kg



Electric Rice Cooker, Flip Lid 电饭锅

Code	8170808
Power Output	1950 watts
Voltage	240V/50Hz
Rice Capacity	8 L
Dimension (l x d x h)	43 x 43 x 43 cm
Weight	8 kg



Electric Rice Cooker, Flip Lid 电饭锅



Code	8170400
Power Output	1,610 watts
Voltage	230-240V / 50Hz
Rice Capacity	6 L
Dimension (l x d x h)	36 x 42 x 38.3 cm
Weight	8.5 kg



Electric Rice Cooker 电饭锅



Code	8170527
Power Output	850 watts
Voltage	230-240V / 50Hz
Rice Capacity	2.7 L
Dimension	37.8 x 33 x 35.2 cm
Weight	5.5 kg



Electric Rice Cooker 电饭锅



Code	8170627
Power Output	850 watts
Voltage	230-240V / 50Hz
Rice Capacity	2.7 L
Dimension	37.8 x 33 x 35.2 cm
Weight	5.5 kg





Electric Rice Warmer 电保温饭桶

8 L

Code	5172708
Power Output	88 watts
Voltage	230-240V / 50Hz
Rice Capacity	8.0 L
Dimension (l x d x h)	43 x 43 x 43 cm
Weight	7.6kg

9.6 L

Code	5172808
Power Output	88 watts
Voltage	230-240V / 50Hz
Rice Capacity	9.6 L
Dimension (l x d x h)	43 x 43 x 46 cm
Weight	8 kg



Electric Rice Warmer, 8 L 电保温饭桶

Code	8170300
Power Output	105 watts
Voltage	230-240V / 50Hz
Rice Capacity	8.0 L
Dimension (l x d x h)	43 x 43 x 43 cm



Electric Rice Warmer, 10 L 电保温饭桶

Code	8170301
Power Output	110 watts
Voltage	230-240V / 50Hz
Rice Capacity	10 L
Dimension (l x d x h)	43 x 43 x 46 cm



Insulated Rice Warmer 不锈钢保温饭桶



3.9 L

Code	8170739
Rice Capacity	3.9 L
Dimension	43 x 36 x 25 cm

5.7 L

Code	8170757
Rice Capacity	5.7 L
Dimension	43 x 36 x 31 cm

Electric Soup Warmer, 12 L

电保温汤桶

Code	5172500
Power Output	475 watts
Voltage	230-240V / 50Hz
Rice Capacity	12 L
Dimension (l x d x h)	42 x 42 x 39.5 cm
Weight	6 kg

**Electric Soup Warmer, 12 L**

电保温汤桶

Code	5172600
Power Output	400 watts
Voltage	220V / 50Hz
Rice Capacity	12 L
Dimension (l x d x h)	34 x 34 x 39.5 cm
Weight	4.7 kg

**Electric Soup Warmer, 5.7 L**

电保温汤桶

Code	5172601
Power Output	300 watts
Voltage	220V / 50Hz
Rice Capacity	5.7 L
Dimension (l x d x h)	28 x 28 x 39.5 cm
Weight	3.5 kg

**Automatic Rice Washer**

洗米机

25 L

Code	8171025
Capacity	25 L
Dimension (l x d x h)	45 x 35 x 75 cm

50 L

Code	8171050
Capacity	50 L
Dimension (l x d x h)	55 x 45 x 85 cm





Feature

The Mirage® Buffet Induction Warmers, available in countertop and drop-in styles, are ideally suited for buffet and catering operations.

Maximize your menu offerings without maxing out your electrical capacity. The low wattage warmers can be interconnected to one electrical outlet, which simplifies the planning and management of power cords, access to outlets and load capacity.

The Mirage® Buffet Induction Warmers are equipped with a variety of safety features including:

- Over-heat protection
- Small-article detection
- Pan auto-detection function
- Empty-pan shut-off



Black



Silver

Counter Top Buffet Induction Warmers 电磁炉

Code	8180401-XX
Power	600 watts
Voltage	230-240V / 50-60Hz
Max Detectable Pan Size	35.6cm
Dimension (l x d x h)	40.6 x 40.6 x 7.8 cm
Weight	6.9 kg
Available Colour	● BK ● SV

* When Ordering BLACK Induction, add CODE suffix to item number (example: 8180401-BK)



** Connect up to three warmers with the included interconnect cords & 1 main cable to Power Point.



Drop-In Buffet Induction Warmers 电磁炉

Code	8180402
Power	600 watts
Voltage	230-240V / 50-60Hz
Max Detectable Pan Size	35.6cm
Dimension (l x d x h)	40.6 x 40.6 x 7.8 cm
Weight	6.9 kg

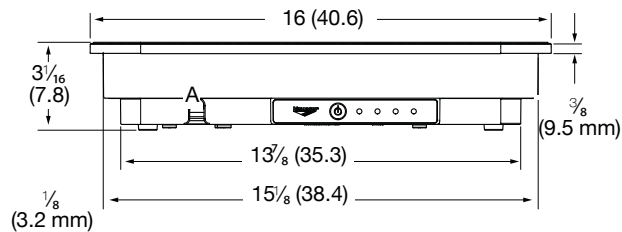
MIRAGE® DROP-IN COUNTER BUFFET INDUCTION WARMERS SPECIFICATION
DIMENSIONS (Shown in inches (cm))

Front View

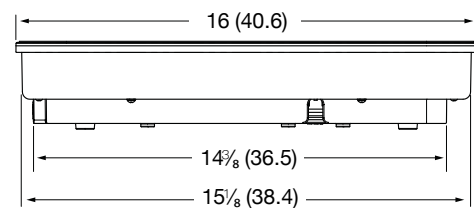

Side View

Drop-in Model, Overhung Installation

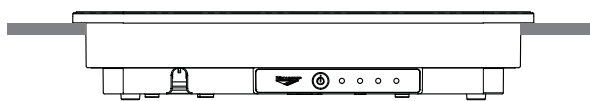

Drop-in Model, Countersunk Installation

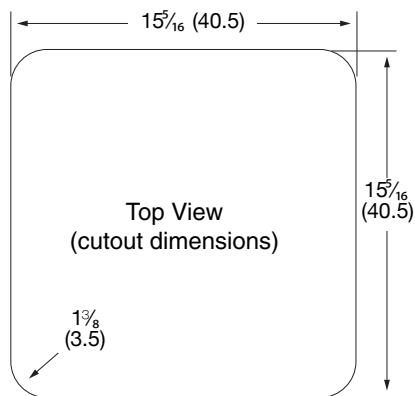
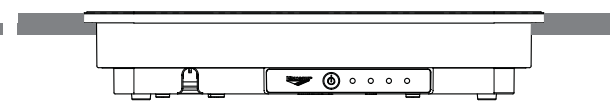
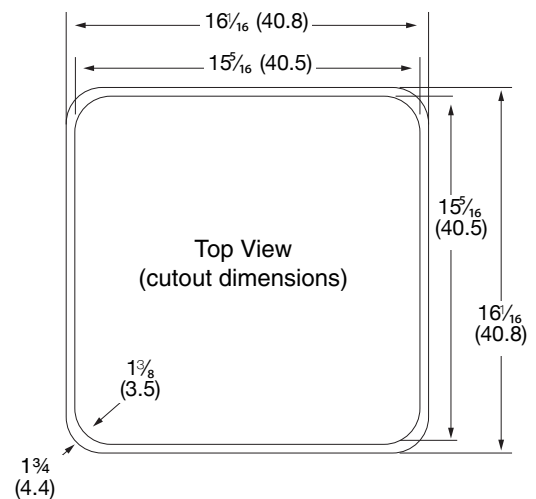
Top View
(cutout dimensions)Top View
(cutout dimensions)

Control Box (drop-in models only)

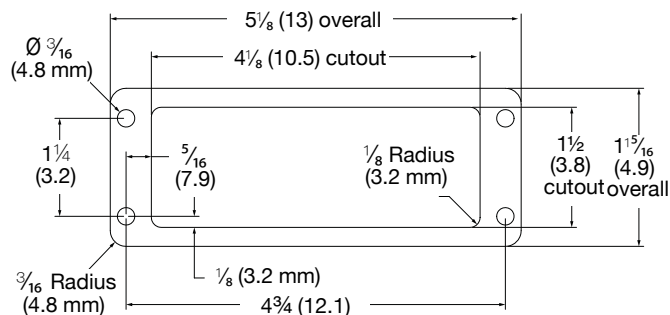

Face View

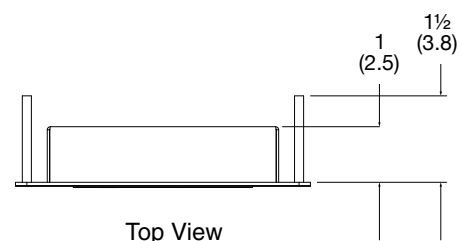

Top View

Counter Top Induction Cooker, 1800 Watts
电磁炉

Code	8180101
Power	1,800 watts
Voltage	230V / 50-60Hz
Max Detectable Pan Size	35.6cm
Dimension (l x d x h)	35.6 x 38.7 x 7.6 cm
Weight	5.8 kg

FEATURES

- Power and temperature control
- 100 power levels
- Temperature control in °F and °C
- Variable-speed knob for fast adjustment
- Fast, high temperature cooking
- Sensitive low-end control
- 180 minute timer
- 90% efficiency rating
- Control box displays HOT when drop-in is turned off if the top is still hot
- Digital display is easy to clean and read
- Drop-in has 6-ft. (183 cm) cord with plug
- Control box cable is 59 inches (1.5 meters)



Drop-In Induction Cooker, 1,800 Watts 电磁炉



Code	8180102
Power	1,800 watts
Voltage	230V / 50-60Hz
Max Detectable Pan Size	35.6cm
Dimension (l x d x h)	31.8 x 36.8 x 7.3 cm
Weight	5.8 kg

FEATURES

- Power and temperature control
- 100 power levels
- Temperature control in °F and °C
- Variable-speed knob for fast adjustment
- Fast, high temperature cooking
- Sensitive low-end control
- 180 minute timer
- 90% efficiency rating
- Control box displays HOT when drop-in is turned off if the top is still hot
- Digital display is easy to clean and read
- Drop-in has 6-ft. (183 cm) cord with plug
- Control box cable is 59 inches (1.5 meters)



Drop-In Induction Warmer, 650 Watts 电磁炉



Code	8180501
Power	650 watts
Voltage	230V / 50-60Hz
Max Detectable Pan Size	35.6cm
Dimension (l x d x h)	31.8 x 36.8 x 7.3 cm
Weight	5.8 kg

FEATURES

- G4 engine for long life
- 5 power levels
- Variable-speed knob for fast adjustment
- 180 minute timer
- 90% efficiency rating
- Control box displays HOT when drop-in is turned off if the top is still hot
- Digital display is easy to clean and read
- Drop-in has 6-ft. (183 cm) cord with plug
- Control box cable is 59 inches (1.5 meters)

MIRAGE® DROP-IN INDUCTION RANGES SPECIFICATION For Model : 8180102 & 8180501

DIMENSIONS (Shown in inches (cm))

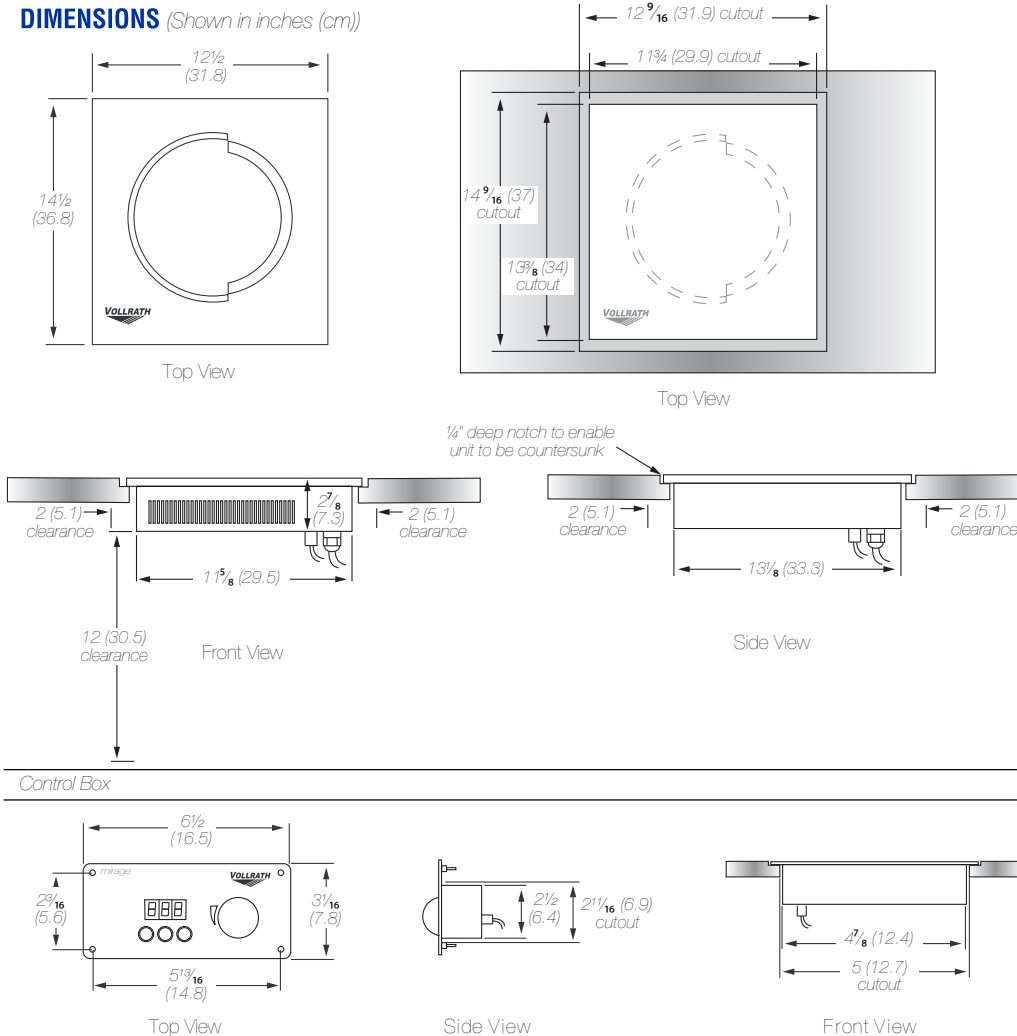

ADVENTYS, based in Burgundy, France, manufactures and markets kitchen equipment with induction technology for hotels, restaurants, and catering businesses. Our expertise, research and development team, and our integrated process define ADVENTYS and its objectives to give our customers the best induction solution. Thanks to our integrated manufacturing process, we are able to create custom-made products and answer your requests: specific dimensions, look & design, and power.

Adventys designs, creates, and manufacture all products on site, in Burgundy. With our electronic shop, our metal shop, our R&D department, and our assembly lines, the production is entirely made by us. Our products are 100% Made in France.

Counter Top Induction Range

电磁炉

	AL 3000	AL 3500
Code	8181030	8181035
Power	3,000 watts	3,500 watts
Voltage	230V / 50-60Hz	230V / 50-60Hz
Amp load	13 A	15 A
Cooking surface	Vitroceraic top glass	Vitroceraic top glass
Control panel	Glass touches	Glass touches
Dimension (l x d x h)	39 x 45 x 10.7 cm	39 x 45 x 10.7 cm
Weight	6.1 kg	6.1 kg

On/Off, manual power setting (+/-) and timer control with 2 digits display (works for both timer and power)



Counter Top Induction - Wok

电磁炉

	GLW 3000	GLW 3500
Code	8181130	8181135
Power	3,000 watts	3,500 watts
Voltage	230V / 50-60Hz	230V / 50-60Hz
Amp load	13 A	15 A
Cooking surface	Vitroceraic wok bowl	Vitroceraic wok bowl
Control panel	Glass touches	Glass touches
Dimension (l x d x h)	42.9 x 39.0 x 15.6 cm	42.9 x 39.0 x 15.6 cm
Weight	10.1 kg	10.1 kg

On/Off, manual power setting (+/-) and timer control with 2 digits display (works for both timer and power)



Touch Panel Induction

电磁炉

	NRIC 2800
Code	8181228
Power	2,800 watts
Voltage	230V / 50-60Hz
Amp load	12 A
Cooking surface	Vitroceraic top glass
Control panel	Glass touches
Dimension (l x d x h)	36.5 x 46.1 x 8.0 cm
Weight	6 kg

On/Off, manual power setting (+/-) and timer control with 2 digits display (works for both timer and power)



H/D Counter Top Induction Range

电磁炉

	BRIC 3000	BRIC 3600
Code	8181330	8181336
Power	3,000 watts	3,600 watts
Voltage	230V / 50-60Hz	230V / 50-60Hz
Amp load	13 A	16 A
Cooking surface	Vitroceraic top	Vitroceraic top
Control panel	Glass touches	Glass touches
Dimension (l x d x h)	52.6 x 39.2 x 9.6 cm	52.6 x 39.2 x 9.6 cm
Weight	8.4 kg	8.4 kg

On/Off, manual power and temperature setting (+/-) with 4 digits display, 2 presets and timer control with 2 digits display. New : lockable panel control.





Economy Induction Cooker, 3000 watts 电磁炉 (经济型)

Code	8180300
Power	3,000 watts
Voltage	220-240V / 50-60Hz
Max Detectable Pan Size	35.6cm
Dimension (l x d x h)	34 x 44 x 11.7 cm
Weight	7 kg

- LED display (0-180 minute)
- 1-10 Power levels
- 1-10 temperature setting
- Temperature rang: 60°C-240°C

Electric Domestic Single Hot Plate 电热板



Code	8180901
Power	1,575 watts
Voltage	220-240V / 50-60Hz
Hot Plate Diameter	15 cm
Dimension (l x d x h)	25 x 25 x 9 cm
Weight	2 kg
Body	Painted

Code	8180902
Power	1,575 watts
Voltage	220-240V / 50-60Hz
Hot Plate Diameter	15 cm
Dimension (l x d x h)	25 x 25 x 9 cm
Weight	2 kg
Body	Stainless Steel

Electric Domestic Double Hot Plate 电热板



Code	8180903
Power	2,360 watts
Voltage	220-240V / 50-60Hz
Hot Plate Diameter	15 cm
Dimension (l x d x h)	47 x 29 x 9 cm
Weight	3 kg
Body	Painted

Code	8180904
Power	2,360 watts
Voltage	220-240V / 50-60Hz
Hot Plate Diameter	15 cm
Dimension (l x d x h)	47 x 29 x 9 cm
Weight	3 kg
Body	Stainless Steel

- Painted Or Stainless steel body
- Non-stick cast iron heating plate
- Unique 4-Heaters
- Modern Elegant Design
- Variable Heat Settings
- With Indicator Lights



Table Top Gas Stove Single Ring 台式燃气灶

Rinnai

Code	8180700
Power Output (kw/h)	3.7 - 4.30
Ignition Type	Piezo Ignition
Dimension (l x d x h)	28 x 38 x 14 cm
Weight	4.5 kg

Table Top Gas Stove Double Ring

双头不锈钢台式燃气灶

Code	8180800
Ignition Type	Piezo Ignition
Dimension (l x d x h)	76.5 x 41.3 x 13 cm
Weight	4 kg
Type	LPG



Code	8180801
Ignition Type	Piezo Ignition
Dimension (l x d x h)	76.5 x 41.3 x 13 cm
Weight	4 kg
Type	TG

Portable Gas Stove

瓶装煤气炉

Code	5160500
Ignition Type	Automatic Ignition
Dimension (l x d x h)	34 x 26 x 8 cm
Weight	2 kg



Gas Cartridge

瓶装煤气

Code	2310800
Capacity	250 ml
Packing	48 Cans/Box



EQUIPMENT

Single Tube High Pressure Gas Stove

单管高压煤气炉



Code	8190110	Code	8190205	Code	8190300
Dimension	72 x 26 x 8.5 cm	Dimension	53.5 x 33.2 x 18.2 cm	Dimension	39 x 15 x 8 cm
Type	LPG	Type	LPG	Type	TG

Two Tube High Pressure Gas Stove

双管高压煤气炉



Code	8190410	Code	8190405
Dimension	72 x 26 x 8.5 cm	Dimension	53.5 x 33.2 x 18.2 cm
Type	LPG	Type	TG

Green Gas Stove

青色煤气炉



Single Tube

Two Tube

Three Tube

Code	8190610	Code	8190830	Code	8191040
Dimension	41 x 27 x 10 cm	Dimension	49 x 29.5 x 11 cm	Dimension	54.5 x 33.0 x 11.0 cm
Type	LPG	Type	LPG	Type	LPG
Code	8190710	Code	8190930	Code	8191140
Dimension	41 x 27 x 10 cm	Dimension	49 x 29.5 x 11 cm	Dimension	54.5 x 33.0 x 11.0 cm
Type	TG	Type	TG	Type	TG

Four Tube



Code	8191250
Dimension	69.5 x 43.5 x 13.5 cm
Type	LPG
Code	8191350
Dimension	69.5 x 43.5 x 13.5 cm
Type	TG



Gas Planetary Wok Cooker (Gas Heating) 煤气行星炒锅

Code	8200140
Voltage	230V/50Hz for spiral
Pot Size	60 x 32 cm
Capacity	40 L
Dimension (l x d x h)	75 x 98 x 175 cm

Code	8200180
Voltage	230V/50Hz for spiral
Pot Size	72.5 x 38 cm
Capacity	80 L
Dimension (l x d x h)	82 x 116 x 175 cm

Code	8200115
Voltage	230V/50Hz for spiral
Pot Size	85 x 43 cm
Capacity	150 L
Dimension (l x d x h)	95 x 125 x 175 cm





Control Panel

Counter Top Heated Glass Display Warmer 保温炉



Code	8200700
Power	327 watts
Voltage	220-240V / 50-60Hz
Glass Dimension (w x d)	40 x 52 cm
Dimension (l x d x h)	40 x 60 x 5.6 cm
Weight	6.5 kg

- Electronic temperature control with five settings for 55°C, 65°C, 75°C, 85°C and 95°C
- Portable and modular system design for great flexibility
- All units come with 1830 mm cord & British plug
- Simple design for easy cleaning and maintenance
- Durable stainless steel housing



Counter Top Heated Glass Display Warmer 保温炉



Code	8200600
Power	430 watts
Voltage	230V / 50-60Hz
Temperature Control	0 - 60 °C
Glass Dimension (w x d)	50 x 50 cm
Dimension (l x d x h)	50 x 50 x 9 cm
Weight	13.4 kg

- Sturdy and compact structure.
- Made from AISI 340 stainless steel.
- Shock-proof heating elements.
- Temperature adjustable by means of a thermostat from 0 to 60°C
- Pilot light.

Refrigerated Cold Display Shelf 显示屏(冷)



Structure in anodized aluminum with inserts in stainless steel.

- Doors in transparent collision-proof Plexiglas that open on both sides.
- Airtight tank in stainless steel.
- Min. temperature 3° C.
- Digital thermal switch with temperature display.
- Optional lighting LED.
- Trays not included.

Easycold 100

- 2 trays 1/2 gastronorm h. 40 mm
- 4 trays 1/4 gastronorm h. 40 mm

Easycold 130

- 3 trays 1/2 gastronorm h. 40 mm
- 6 trays 1/4 gastronorm h. 40 mm

Easycold 100

Code	8201400
Power	150 watts
Voltage	230V / 50-60Hz
Min Temperature	3°C
Dimension (l x d x h)	95 x 43.4 x 22 cm
Weight	28 kg

Easycold 130

Code	8201401
Power	150 watts
Voltage	230V / 50-60Hz
Min Temperature	3°C
Dimension (l x d x h)	128 x 43.4 x 22 cm
Weight	33 kg



Electric Display Warmer

保温显示屏

**1 Shelf**

Code	8200501
Power	450 watts
Voltage	230V / 50-60Hz
Max Temperature	90°C
Shelf Dimension (l x d)	48 x 29 cm
Dimension (l x d x h)	50 x 35.5 x 32.5 cm
Weight	8 kg

2 Shelf

Code	8200502
Power	450 watts
Voltage	230V / 50-60Hz
Max Temperature	90°C
1st Shelf Dimension (l x d)	48 x 29 cm
2nd Shelf Dimension (l x d)	48 x 26.5 cm
Dimension (l x d x h)	50 x 35.5 x 40.5 cm
Weight	10 kg

- Case for displaying and storing croissants, cakes and other snacks
- Available with 1 or 2 levels
- S/S extractable product holding surfaces
- Aluminium, perfectly smooth base easy to clean
- Transparent plexiglas structure and anodized aluminium profiles
- 2 vertically openable doors

**Electric Display Warmer, 3 Shelf**

保温显示屏



Code	8201500
Power	450 watts
Voltage	230V / 50-60Hz
Max Temperature	70°C
1st Shelf Dimension (l x d)	53 x 35.6 cm
2nd Shelf Dimension (l x d)	53 x 35 cm
3rd Shelf Dimension (l x d)	53 x 30 cm
Dimension (l x d x h)	55 x 40.5 x 56.5 cm
Weight	16 kg

- Case for displaying and storing croissants, cakes and other snacks.
- Transparent Plexiglas structure and anodized aluminium profiles.
- S/S extractable product holding surfaces.
- 2 vertically openable doors.

Available even in the hot version with adjustable thermostat up to 70° C.

- Water tank to maintain humidity.

**Electric Display Warmer, 3 Shelf**

保温显示屏



Code	8201300
Power	450 watts
Voltage	230V / 50-60Hz
Max Temperature	70°C
1st Shelf Dimension (l x d)	28 x 38 cm
2nd Shelf Dimension (l x d)	28 x 38 cm
3rd Shelf Dimension (l x d)	28 x 38 cm
Dimension (l x d x h)	30 x 45 x 70.5 cm
Weight	14 kg





Electric Food Display Warmer 电保温柜

Code	8201014
Power	850 watts
Voltage	220-240V
Temperature	30°C - 85°C
Dimension (l x d x h)	55 x 45 x 77 cm
Weight	40 kg



Electric Food Display Steamer 电蒸包柜

5 Tray

Code	8201160
Power	900 watts
Voltage	220-240V
Dimension (l x d x h)	38 x 40 x 74.5 cm
Weight	22 kg

6 Tray

Code	8201150
Power	900 watts
Voltage	220-240V
Dimension (l x d x h)	60 x 52 x 85 cm
Weight	40 kg



Freestanding Drawer Warmers 电保温柜



HDW 1

Code	8201601
Power	450 watts
Voltage	240V, 50Hz
Dimension (l x d x h)	74.9 x 57.5 x 27.9 cm
Weight	44 kg

HDW 2

Code	8201602
Power	900 watts
Voltage	240V, 50Hz
Dimension (l x d x h)	74.9 x 57.5 x 53.7 cm
Weight	76 kg



Hold everything from meat to vegetables to rolls in the Hatco Freestanding Drawer Warmer. Built for tough kitchen duty with rugged stainless steel construction and heavy-duty hardware, these warmers keep a variety of foods hot and fresh until served.

- Each drawer has a food pan, recessed individual thermostatic control, temperature monitor, vent slides and power switch.
- Completely insulated individual cavities provide maximum energy efficiency.
- Standard 6" (152 mm) deep pan supplied with each drawer lifts straight out.
- Drawer fronts available in all Designer colors (standard stainless steel) to match your décor.

Boil Steam Warmer, RCTHW-1

电保温箱



Code	8201701
Power	3,000 watts
Voltage	220-240V / 50-60Hz
Dimension (l x d x h)	36.8 x 61.1 x 28.3 cm
Weight	10 kg

Pasta Cooker Adapter for RCTHW-1

Code	8201701-1
-------------	------------------

Hatco Heat-Max Rectangular Heated Wells are specially-designed to hold a variety of foods, including soups, gravies and more, at desired and safe-serving temperatures.

- Includes a control panel featuring three temperature set points from 50°C to 100°C (122°F to 212°F) and an electronic controller to monitor the temperature for optimum results.
- Features an energy-saving low power mode for off-peak hours.
- Unique dome-shaped element prevents the bottom from warping after long periods of use.



8201701-1

Round Heated Well Soup Warmer

电保温柜

**RHW 1**

Code	8201801
Power	1250 watts
Voltage	230V
Dimension (l x d x h)	35.9 x 33.0 x 34.3 cm
Weight	10 kg

RHW 2

Code	8201802
Power	2500 watts
Voltage	230V
Dimension (l x d x h)	63.0 x 33.0 x 34.3 cm
Weight	17 kg

Hatco Heat-Max Portable Round Heated Wells are specially-designed to cook and hold a variety of foods, including pastas, soups, gravies and more, at desired and safe-serving temperatures.

- Includes a control panel featuring three temperature set points from 50°C to 100°C (122°F to 212°F) and an electronic controller to monitor the temperature for optimum results.
- Features an energy-saving low power mode for off-peak hours.

**Food Serving Trolley**

食物餐车

BLANCO**SAW 1**

Code	9040801
Power	700 watts
Voltage	220-240V, 50-60 Hz
Capacity	1x GN 1/1-200 or its subdivisions
Dimension (l x d x h)	75.0 x 50.8 x 93.3 cm
Weight	24.5 kg

SAW 2

Code	9040701
Power	1,400 watts
Voltage	220-240V, 50-60 Hz
Capacity	2x GN 1/1-200 or its subdivisions
Dimension (l x d x h)	93.6 x 71.4 x 93.3 cm
Weight	35.5 kg

Reliable, durable, resilient: Food distribution trolleys from BLANCO are impressive with their user-friendly functionality and ergonomic design. They form part of the BLANCO system range for food distribution. All products from the BLANCO system range are matched up perfectly. They help to optimise the process flow in a cost-effective, quality-conscious and efficient way.

Quality that gets people looking:
 Made of CNS 18/10 stainless steel with a micro-polished surface for optimum hygiene
 Quality Made in Germany
 Splashed and sprayed-water protection in compliance with IP X5
 Safety push handle with side impact protection elements
 Rugged, wide polyamide corner guards
 Practical options, e.g. fold-out shelf, lid receptacle, sliding cover
 With synthetic castors in accordance with DIN 18867, Part 8
 Also available with many other castor types



SAW 1-9040801



SAW 2-9040701

Glo-Ray® Infrared Strip Heaters

电保温器



18 "

Code	8211218
Power	350 watts
Voltage	230-240V
Type of Switch	Toggle Switch
Dimension (l x d x h)	45.7 x 15.3 x 6.4 cm
Weight	3 kg

24 "

Code	8211224
Power	500 watts
Voltage	230-240V
Type of Switch	Toggle Switch
Dimension (l x d x h)	61 x 15.3 x 6.4 cm
Weight	3 kg

30 "

Code	8211230
Power	660 watts
Voltage	230-240V
Type of Switch	Toggle Switch
Dimension (l x d x h)	76.2 x 15.3 x 6.4 cm
Weight	4 kg

36 "

Code	8211236
Power	800 watts
Voltage	230-240V
Type of Switch	Toggle Switch
Dimension (l x d x h)	91.4 x 15.3 x 6.4 cm
Weight	4 kg

48 "

Code	8211248
Power	1,100 watts
Voltage	230-240V
Type of Switch	Toggle Switch
Dimension (l x d x h)	121.9 x 15.3 x 6.4 cm
Weight	5 kg

Safely hold the temperature of your product without drying out or further cooking food with Hatco's Glo-Ray® Infrared Aluminum Strip Heaters. The end result is hot, fresh food that's ready-to-serve. The continuous aluminum housing and heavy-duty mountings ensure the durability and quality of Hatco products.

Standard features

- Prefocused heat pattern covers the entire holding surface
- Consistent holding temperatures with no "cold spots"
- Sturdy extruded aluminum housings that do not sag, in widths from 18" to 144" (457 to 3658 mm). Please request from us for length more than 48"
- Standard and high watt models available
- Reflector does not blacken, maintaining a consistent heat pattern
- Protective wire guards under heating element
- Insulation minimizes heat loss
- Factory assembled with mounting tabs, ready to install quickly and easily
- All units single phase only



Details Of Strip Heater Recommended Range Above Target* and Strip Heater Spacing Requirements

Based on 24" Strip Heaters

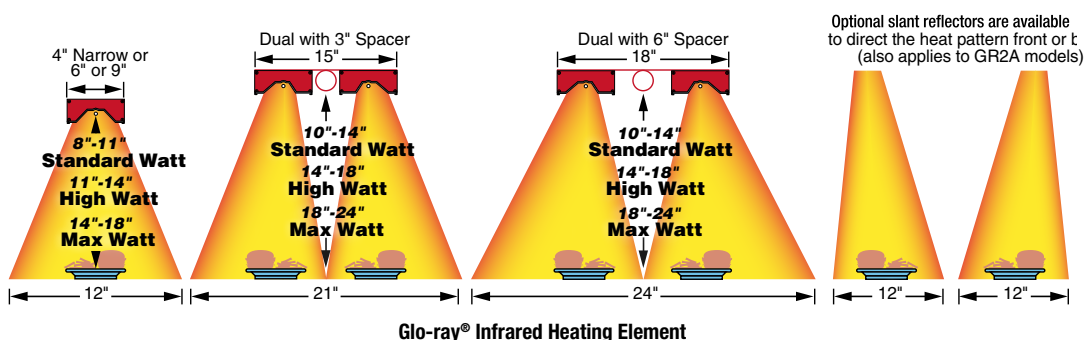

Providing proper food serving temperatures, the Hatco Freestanding Decorative Carving Station is ideal for chef stations in restaurants, hotels, country clubs, casinos and catered events.

Patented telescoping heated Decorative Lamp with a 30° shade pivot adjusts easily to accommodate food products.
Decorative Lamps and posts available in Plated finishes Bright Brass, Bright Nickel (standard) and Antique Bronze to match your décor.

Comes standard with a clear-coated, 250 watt bulb.
Height Can be Adjusted between 15" to 27" (381 to 686 mm)



Free Standing Decorative Heating Lamp

单头电热保温灯

Code	4111201
Power	250 watts
Voltage	230-240V
Dimension (l x d x h)	28.7 x 52.7 x 86.4 cm
Weight	18 kg



Carving Station with Heated Board

电热保温灯切割台

- Heated base is controlled by an adjustable thermostat and power switch
- Heated stone bases, post bases and cutting boards are made of foodsafe materials
- Sneeze guard is 5" (127 mm) above base for easy accessibility
- Swanstone cutting board matches color of base

Rectangle 20" x 24"

Code	4110701
Power	750 watts
Voltage	230-240V
Board Dimension	60.9 x 50.8
Dimension (l x d x h)	60.8 x 50.6 x 116.8 cm
Weight	46 kg



Rectangle 36" x 24"

Code	4110702
Power	1,300 watts
Voltage	230-240V
Board Dimension	91.4 x 60.9 cm
Dimension (l x d x h)	91.1 x 61 x 116.8 cm
Weight	68 kg



Round

Code	4110703
Power	600 watts
Voltage	230-240V
Board Dimension	60.9 cm
Dimension (l x d x h)	66 x 68.7 x 116.8 cm
Weight	33 kg



The Glo-Ray® Carving Station is an excellent addition to extend food holding times during serving periods. Create a complete serving station for buffets by adding it to Hatco's Flav-R-Savor® Holding Cabinet

Standard features

- Overhead ceramic heating elements project high intensity radiant heat over entire target area
- Available with or without heated base
- Independent controls de ne temperature settings for the ceramic element top heat and the blanket element base heat (GRCSCLH-24 only)
- Shatter-resistant incandescent lights
- Sturdy right-hand side sneeze guard
- Adjustable clearance of 17" to 23" (445 to 570 mm) from the top of the base to the bottom of the foodwarmer housing
- Portable – includes a 72" (1829 mm) cord and plug



Glo-Ray® Carving Stations with Right Sneeze Guard 电热保温灯切割台

Code	4110704
Power	1,316 watts
Voltage	230-240V
Board Dimension	49.6 x 71.2 cm
Dimension (w x d x h)	58.4 x 71.2 x 72.4 cm (66.1cm width if include Left Hand Sneeze Guard)
Weight	24 kg

OPTIONAL Accessories

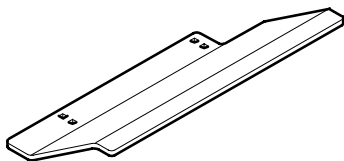

Left Hand Sneeze Guard

Code	4110705
Dimension (length)	63.5 cm
Weight	1 kg

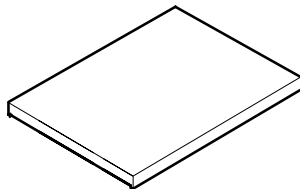

Stainless Steel Drip Pan

Code	4110706
Dimension (w x d x h)	50.8 x 60.8 x 2.5 cm
Weight	4 kg

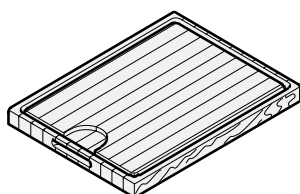

Wooden Carving Board

Code	4110707
Dimension (w x d x h)	45.7 x 61.0 x 4.5 cm
Weight	9 kg

Hatco Decorative Lamps provide radiant heat to briefly hold food warm at kitchen work areas, waitress pickup stations, or customer serving points, while enhancing your décor. Versatile enough for any location, the range of lights are available with a selection of unlimited personalizing choices. In addition to food warming, configurations for lighting (Luminaire) is offered as well.

FLEXIBILITY

The Hatco DL series offers great flexibility with standard and high watt bulbs, or lighting only applications, nine lamp shade styles, eight different mounting arrangements, four switch options, and twenty colors to customize your operation.

QUALITY

The following features assure the finest performance for years to come.

- Standard and high watt bulbs available.
- Models available in nine lamp shade styles.
- Eight different mounting arrangements to choose from.
- Four switch options.
- Available in seven Designer colors: Warm Red, Black, Gray Granite, White Granite, Navy Blue, Hunter Green, Antique Copper.
- Available in seven gloss finishes: Smooth White, Gleaming Gold, Glossy Gray, Bold Black, Radiant Red (lampshade only), Brilliant Blue (lampshade only), Clear Brushed Metal (lampshade only) (Special processing required)
- Available in six plated finishes: Bright Brass, Bright Nickel, Bright Copper, Antique Brass, Antique Nickel, Antique Bronze (Special processing required)
- Available for food holding and display, or lighting only applications.



Decorative Retractable Ceiling Mount Heating Lamp

保温灯

Lamp Shades: 700 Series

Code	8210300-XX
Power	250 watts
Voltage	230-240V
Retractable Length	84.8 - 128.6cm
Switch Location	Lower Switch
Shades Diameter	16.5 cm
Weight	6 kg
Colours Available:	■ AB, ■ BC, ■ BN

When ordering , add colour CODE suffix to item code. (eg: 8210300-BN)



Decorative Retractable Ceiling Mount Heating Lamp

保温灯

Lamp Shades: 775 Series

Code	8210301-XX
Power	250 watts
Voltage	230-240V
Retractable Length	84.8 - 128.6cm
Switch Location	Lower Switch
Shades Diameter	16.5 cm
Weight	6 kg
Colours Available:	■ AB, ■ BC, ■ BN

When ordering , add colour CODE suffix to item code. (eg: 8210300-AB)



scan to download the brochure to make your selection

* Available lamp shapes for your selection





Free Standing Decorative Heating Lamp 保温灯

Hanson Brass

Code	4110601-XX
Power	250 watts
Voltage	230-240V
Dimension (W x d x h)	24 x 45 x 70 cm
Weight	15 kg
Colours Available:	BC, BN

When ordering , add colour CODE suffix to item code. (eg: 4110601-BC)



Free Standing Decorative Heating Lamp 保温灯

Hanson Brass

Code	4110602-XX
Power	500 watts
Voltage	230-240V
Dimension (W x d x h)	40 x 45 x 70 cm
Weight	25 kg
Colours Available:	BC, BN

When ordering , add colour CODE suffix to item code. (eg: 4110602 -BC)



Dual Lamp Carving Stations with Sneeze Guard 保温灯

Hanson Brass

Code	4110501
Power	500 watts
Voltage	230-240V
Dimension (W x d x h)	91.5 x 51 x 70 cm
Weight	30 kg

Complete with 2 Single Lamp Fixtures
Complete with Sneeze Guard
Complete with White Solid Surface
Bright Nickel Finish



Single Lamp Carving Stations (Black Granite Base) 保温灯

Hanson Brass

Code	4110101
Power	250 watts
Voltage	230-240V
Dimension (W x d x h)	46 x 51 x 70 cm
Weight	18 kg

Dual Lamp Carving Stations (Black Granite Base)

保温灯

Hanson Brass

Code	4110102-XX
Power	500 watts
Voltage	230-240V
Dimension (W x d x h)	46 x 51 x 70 cm
Weight	18 kg
Colours Available:	BC, BN

When ordering , add colour CODE suffix to item code. (eg: 4110102-BC)



Dual Lamp Carving Stations (White Solid Surface)

保温灯

Hanson Brass

Code	4110202
Power	500 watts
Voltage	230-240V
Dimension (W x d x h)	46 x 51 x 70 cm
Weight	18 kg



Dual Lamp Carving Stations (Black Solid Surface)

保温灯

Hanson Brass

Code	4110302-XX
Power	500 watts
Voltage	230-240V
Dimension (W x d x h)	46 x 51 x 70 cm
Weight	18 kg
Colours Available:	BC, BN

When ordering , add colour CODE suffix to item code. (eg: 4110302-BC)



Single Lamp Carving Stations 保温灯

Hanson Brass

White solid surface

Code	4110401
Power	250 watts
Voltage	230-240V
Dimension (W x d x h)	46 x 51 x 70 cm
Weight	18 kg

Black solid surface

Code	4110402
Power	250 watts
Voltage	230-240V
Dimension (W x d x h)	46 x 51 x 70 cm
Weight	18 kg





Infrared Radiator Bulb 红外辐射加热灯

Red Light

Code	4110801
Power	250 watts
Voltage	230V

White Light

Code	4110802
Power	250 watts
Voltage	230V



Free Standing Food Warmer 保温炉

Code	4110901
Power	250 watts
Voltage	240V
Dimension (W x d x h)	32.9 x 64.2 x 42.7 cm
Weight	8 kg

Provides heat for your cooked food from above with a 500W infra-red heat element, enclosed with a metal covering. Designed to keep food at safe temperatures preventing overcooking & cooling off.
Steel-plated Aluminium
Sleek black design with rounded edges
Fits Gastronorm 1/1 Pan
Display sign holder at front Incandescent lights (2 bulbs incl.)



Single Heating Lamp Free Standing, Economy 保温灯

Code	4111001
Power	250 watts
Voltage	230V
Dimension (W x d x h)	25 x 45 x 70 cm
Weight	15 kg

Complete with 1 x 250 watts White Light Infrared Radiator Bulb



Dual Heating Lamp Free Standing, Economy 保温灯

Code	4111002
Power	500 watts
Voltage	230V
Dimension (W x d x h)	40 x 45 x 70 cm
Weight	18 kg

Complete with 2 x 250 watts White Light Infrared Radiator Bulb

Electric UV knife sterilizer

电刀消毒箱



Steril. UV 16W

Code	8220116
Power	16 watts
Voltage	230V/50Hz
Absorbition	70 watt ~0,3A
Timer	0÷120 min
Knives capacity	15
Max lenght of the blade	31 cm
Dimension (l x d x h)	40 x 14 x 62 cm
Weight	9 kg

Steril. UV 24W

Code	8220124
Power	24 watts
Voltage	230V/50Hz
Absorbition	100 watt ~0,5A
Timer	0÷120 min
Knives capacity	20
Max lenght of the blade	29 cm
Dimension (l x d x h)	40 x 30 x 62 cm
Weight	9 kg

- Made from AISI430 stainless steel.
- Chamber is closed by a smoked plexiglass door.
- Removable see-through plexiglass knives holder makes sanitation easier and allows sterilization without having to rotate the knives.
- Knives holder with built in drops collecting tray (only on 24W version).
- Mercury vapour lamp UVC with wire screen protection.
- A safety microswitch switches the lamps on when the door is opened and switches them off when it is closed.
- The curtesy lamp, on 24W model, turns on only when the switch is "on" and the timer is at "0".



8220116



8220124

Electric Towel Box

电毛巾箱

Hold 50 Towels (Hot)

Code	8220213
Power	180 watts
Voltage	220V / 50Hz
Dimension (l x d x h)	42.2 x 28.5 x 28.0 cm
Weight	6 kg



8220213

Hold 70 Towels (Hot)

Code	8220220
Power	180 watts
Voltage	220V / 50Hz
Dimension (l x d x h)	45.0 x 28.5 x 33.0 cm
Weight	7 kg

8220220
8220320 (Hot & Cold)

Hold 70 Towels (Hot/Cold)

Code	8220320
Power	180 watts
Voltage	220V / 50Hz
Dimension (l x d x h)	45.0 x 28.5 x 33.0 cm
Weight	7 kg



8220245

Hold 140 Towels (Hot)

Code	8220245
Power	2 x180 watts
Voltage	220V / 50Hz
Dimension (l x d x h)	45.0 x 31.0 x 59.5 cm
Weight	12 kg



8220345

Hold 140 Towels (Hot/Cold)

Code	8220345
Power	hot 2 x180 watts, cold 110 watts
Voltage	220V / 50Hz
Dimension (l x d x h)	45.0 x 31.0 x 59.5 cm
Weight	12 kg



Electric Commercial Cutlery Dryer 电餐具烘干 SH3000



Code	8220500
Power	750 watts
Voltage	230V / 50-60Hz
Production	3000-3500 cutlery/hour
Dimension (l x d x h)	57 x 55 x 40 cm
Weight	48 kg

This automatic cutlery dryer machine is designed to dry and polish the cutlery after washing it, getting it brighter and removing the water and lime marks. It dries and polishes automatically your cutlery (not only stainless steel but also silver ones).

It is manufactured in stainless Steel, something that makes it stronger and more reliable when you are working with it.



Electric Commercial Cutlery Dryer 电餐具烘干 SH7000



Code	8220400
Power	850 watts
Voltage	230V / 50-60Hz
Production	7000-8000 cutlery/hour
Dimension (l x d x h)	62 x 65 x 87 cm
Weight	82 kg

Automatic cutlery dryer that not only dries but also polishes and removes the lime marks from your cutlery, Stainless Steel and Silver ones, after washing it.

It is equipped with a UV lamp that sterilizes granulate made of corn that will dry and polish the cutlery. We have also installed a fan motor with a heating element to finish the drying process and avoids some granulate can goes out from the machine.

It is manufactured in stainless Steel, something that makes it stronger and more reliable when you are working with it.



Spare Granulate for Cutlery Dryer 抛光机颗粒



Code	8220609
Weight	9 kg

Upright Electric Bar Glass Washer 电动洗杯机



Code	7150101
Power	850 watts
Voltage	220/240V
Brushes	Four 15 cm, One 18.7 cm
Dimension (l x d x h)	30 x 20 x 30 cm
Weight	11.8 kg

Electric Commercial Glass Dryer

电杯烘干机

frucosol

Code	8220700
Power	1100 watts
Voltage	230V / 50-60Hz
Fan Motor	Hot air
Production	240-360 pieces/hour
Dimension (l x d x h)	34 x 30.5 x 52 cm
Weight	16 kg

A machine for drying and polishing glasses and cups that will finish with the hard job of the manual drying. It will also provide the process with more hygiene and cleanliness, and a professional finishing in a few seconds.

In order to keep your cups and glasses in a perfect hygiene, cleanliness and presentation state we will need a meticulous drying process; the absence of any water or lime marks on the glasses is an essential point in the image of any business.

Its natural, absorbing and flexible brushes can be fit to different cups and glasses sizes and shapes, making easier and decreasing the time you employ in the drying process.



Electric Commercial Glass Dryer

电杯烘干机

frucosol

Code	8220701
Power	2140 watts
Voltage	230V / 50-60Hz
Fan Motor	Hot air
Production	400-500 pieces/hour
Dimension (l x d x h)	59 x 32 x 49 cm
Weight	26 kg

A machine for drying and polishing glasses and cups that will finish with the hard job of manual drying. It will also provide the process with more hygiene and cleanliness, and a professional finishing in a few seconds.

You will decrease the costs of broken cups and glasses as the drying and polishing process with the machine won't make any pressure on it. Its natural, absorbing and flexible brushes can be fit to different cups and glasses sizes and shapes, making easier and decreasing the time you employ in the drying process.



FRONT COOKING

for professionals. The exceptional solution for mobile cooking systems – with ION TEC option.



When cooking in front of guests, professionals must be able to rely on their equipment completely. The BLANCO COOK cooking system passes this test with flying colours and accompanies you wherever cooking is expected to be a performance and savouring begins with watching.

The BLANCO COOK front cooking station is the heart of the mobile cooking system. With its highly efficient extraction and filter technology,

it ensures an optimum climate on the set and frees you from stationary extractor hoods.

The front cooking station is available for two to four cooking units. Thirteen different table-top cooking units enhance the front cooking station even further. They are all reliable, fast, powerful and thus ideal for professional use in canteens, restaurants and dining halls and on hotel terraces.

Another piece of good news: those who cook live using fresh ingredients can increase revenues by up to 40 percent with front cooking compared to classic preparation.

Treat yourself to state-of-the-art technology in a timeless design, select your own combination of front cooking station and cooking units – modern and functional from BLANCO COOK.



WITH A LICENCE TO BREATHE FREELY

The BLANCO COOK front cooking station.

Frying and sizzling, cooking and stirfrying result in cooking fumes which rise up. The extraction bridge of the BLANCO COOK front cooking station collects these fumes above the cooking units, which makes it significantly more efficient than other methods. Thanks to the slim design of the bridge, both the chef and guests have an unobstructed view of food preparation.

Large work surfaces and additional storage space provide enough room for the creativity of the participants.

Tested and proven:

powerful grease filters which correspond to Class A (DIN 18869-5) do not allow the penetration of any flames. This is confirmed by the fire-protection safety report carried out by an independent expert.

And with the optional ION TEC filter technology, BLANCO COOK achieves

even better results in the battle against cooking fumes, and for the first time, also filters blue smoke from the fumes.

The mood also remains high after the cooking show because all of the parts that need to be cleaned can be easily removed without tools and cleaned in the dishwasher.



BC-FS 4 front cooking station, customer side, with optional panelling and railing

**Well-designed down to the smallest detail:
the highlights of the front cooking station.**



Freedom for busy hands

Because the extraction bridge is so thin, more room is left for arranging and placing food.



BLANCO CONTROL – clear and simple

The electronic controller with clear symbols makes operating the front cooking station simple. The filter change indicator automatically reminds you to change or clean the filter.



Filter replacement – quick and easy

Simply lift the lid of the extraction bridge, remove the grease filter and put it into the dishwasher – without using any tools whatsoever.



BC-FS 4 front cooking station, operator side, with optional railing, panelling and a comprehensive range of accessories

**BLANCO COOK
front cooking station**

- The extraction bridge offers ample space for ingredients or serving, whilst affording a clear view of the preparation process.
- Functional design with one-piece flat surfaces.
- Socket outlets behind the cooking units ensure cables are stored safely.
- Fans and filters can be accessed from the cooking side.
- Usable storage space below the placement niche.

FRESH AIR

Our multi-stage model for a comfortable atmosphere –
with ION TEC upon request.

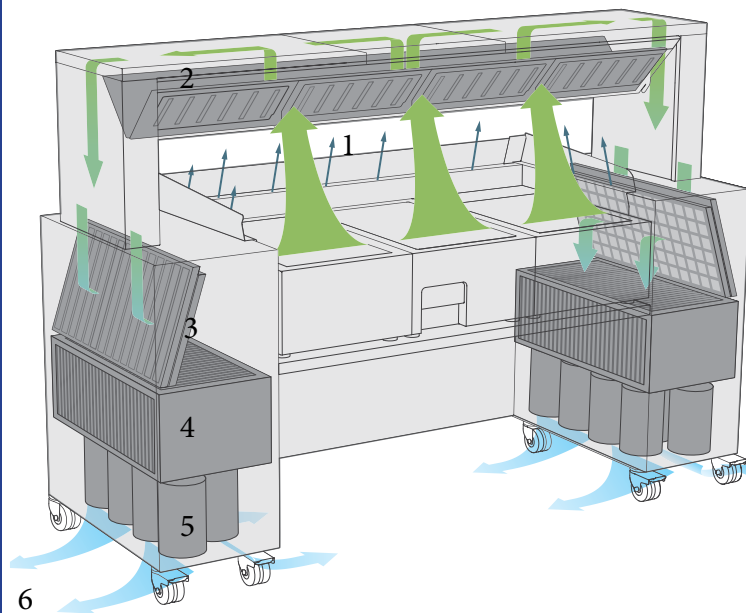

How it works:

- 1 Suction results from a vacuum and draws the fumes into the extraction bridge. To further increase the extraction efficiency, the three-sided air flow also routes the fumes directly into the extraction bridge.
- 2 Grease is separated out and collected in catch trays in the extraction bridge.
- 3 Fleece filters absorb moisture and aerosols.
- 4 Odour particles and blue smoke can be reduced with the optional ION TEC filter system.
- 5 Activated charcoal reliably binds the odour molecules.
- 6 The cleaned air exits downward.

Clever options and accessories:
for individual workplace design.



Perfect protection

The one-piece sneeze guard ensures optimum hygiene. It can be easily folded down for cleaning.



Spotlight on

Integrated and flush LED spots illuminate the entire work surface ideally and put food in the right light.



Please stand

Protected with a railing, the top of the extraction bridge can be used for presentation, decoration and provision.

The ION TEC filter system. Filters blue smoke and increases the service life of the activated charcoal.

How it works:

- 1 Large particles such as grease are separated out in the pre-filtering stages.
- 2 The particles which flow through the ioniser are charged positively by an electrostatic field. In addition, highly reactive ozone is generated from oxygen.
- 3 In the collector stage, the positively charged particles (especially aerosols) are attracted to the negatively charged plates and thus separated out.
- 4 In the oxidation process, the ozone eliminates odours and blue smoke.
- 5 Particles adhering in the activated charcoal which were not yet separated out react with the residual ozone. This cleans the activated charcoal and significantly increases its service life.
- 6 Oxygen, carbon dioxide and water are released into the environment as end products.

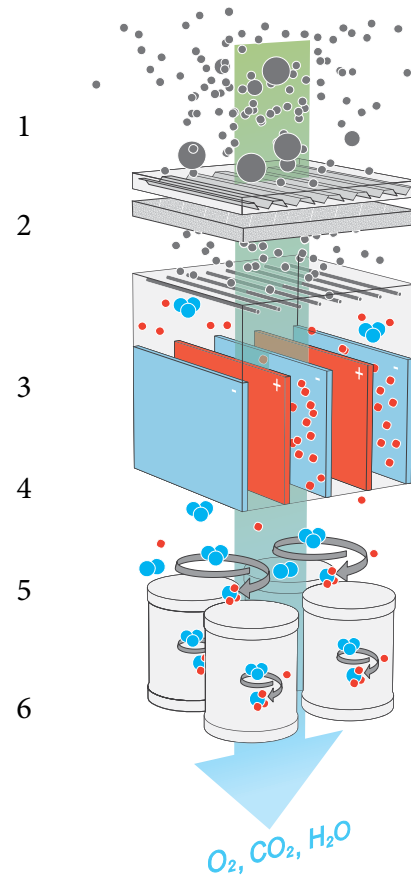

Creates space: multi-frame

The multi-frame offers space for secondary activities such as setting down and storing items. Simply insert a GN container or lay in a glass shelf to create an additional work surface.



Rails for any situation

Please insert anything which should be stored directly under the cooking units here. Food and cooking utensils can disappear into GN 1/1 containers of any depth.



Instant conversion

The cooking unit placement shelf can be easily removed, e.g. to make room for a fixed-position floor unit.

NEW GENERATION

Flexible and reliable assistants on set: everything for heating up and keeping hot.

Filling rush orders: grilling, stir-frying, cooking – these compact, strong assistants make chefs happy! Teams of modular table-top cooking units from the BLANCO COOK system assist kitchen professionals.

The new generation of table-top units unveils a new product design and is 100 % "made in Germany". Good to know: they are compatible with all previous BLANCO COOK units.

New additions: two intelligent induction hobs and the large, highperformance griddle have been energetically optimised.

The induction technology from E.G.O. (Oberderdingen) is characterised by quick speed, especially high dependability and long service life.

The table-top cooking units from the BLANCO COOK system offer you clever technology and reliable performance for professionals.

The high-quality BLANCO design stands for top performance with regard to handling and hygiene. With rotary knob control, you can adapt your energy consumption to the capacity level.

Thanks to the compact design and a depth of just 62 cm, all table-top cooking units fit on all standard worktops and can be flexibly combined.

BLANCO COOK makes working easier!



The front cooking trio for mouthwatering cooking shows:
induction wok, ribbed griddle and pasta cooker

Details that make everyone's mouth water.



Just 62 cm deep: the modules fit on any standard worktop.



Familiar operation: the rotary knobs with continuous temperature or power adjustment ensure familiar, secure operation. The indicator lights display the operating mode.



Always at the right height: the standard height-adjustable feet are easy to adjust. This ensures you can set up BLANCO COOK in one line.



Easy to clean: micro-polished stainless-steel surfaces, large radii, seamlessly welded-in cooking and frying zones simplify cleaning – for outstanding hygiene and optimal, clean working conditions.



Safe handling: practical drain plug, easily accessible catch tray for grease and cooking residues and large-dimensional safety drains for liquids ensure safe working conditions without risk of injury.

NEW: two intelligent induction hobs and a large, high-performance griddle.

New to the team



2-zone induction hob

Frying and keeping hot? The 2-zone induction hob can do it all at once. Higher efficiency through automatic pot detection.



Surface induction hob

Surface efficiency! The rectangular hob provides concentrated energy for pans and casseroles.



Griddle, flat

A small fish or a large turkey breast – this griddle does it all. Separately adjustable heating zones make efficiency possible at the touch of a button.

MODULAR

High-performance table-top cooking units for cooking, grilling, stir-frying, deep-frying and keeping dishes hot in front cooking and catering.



Induction hob

It detects the pot and generates an electromagnetic field which produces heat directly in the bottom of the pot. Due to its sensational efficiency of more than 90 percent, 5 litres of water only need 6.5 minutes to reach boiling point with the BC IH 5000. A welcome side effect is that because of the low heat emission, the workplace is not also heated up.



Induction wok

Energy is transferred to the wok evenly because the induction coil is adapted to the curve of the Ceran® cuvette. There is no need to fear burns because the hob and induction cuvette do not heat up.



Ceran® hob

The rugged Ceran® hob has two cooking zones, which can be set separately. The Ceran glass is 6 mm thick, unbreakable and very easy to clean.



Deep griddles

The versatile deep griddle has a recessed, seamlessly welded griddle surface made of 15 mm-thick chrome steel for perfect grilling results. The large-dimensioned safety drain ensures rapid emptying.



Griddle

Flat or ribbed – a uniform desired temperature is maintained on the seamlessly welded in griddle surface. This is virtually a guarantee for enjoying meat, fish and vegetables in top form. Excessive grease is collected in the large catch tray.





Pasta cooker

A taste for pasta – right away!
The pasta cooker offers space for up to 6 pasta baskets. The seamlessly deep-drawn water well is heating using special heating and is equipped with an opening that can be closed.



Deep fryer

The deep fryer has a swivelling heating element and an unheated cold zone on the bottom of the basin. The temperature is controlled down to the degree via a rotary knob.



Bain-marie

Food can be kept hot or presented in GN containers in a seamlessly deepdrawn well which is thermally separated from the body. The drain valve is located on the outside. There is no danger of scalding.



Hot plate

This large heat-retaining area is also thermally separated from the body. The temperature can be precisely regulated using a rotary knob.



Multi-element

Whoever views this product ends up wanting it because essential items including cooking utensils and ingredients are always within easy reach. The practical compliance with GN dimensions allows quick loading. The multi-element matches the BLANCO COOK table-top cooking units exactly.

FRONT COOKING STATION BC FS

We will be happy to provide you with additional information on these products and on the entire BLANCO product line on request



Model	Front cooking station BC FS 2	Front cooking station BC FS 3	Front cooking station BC FS 4	
Model	Mobile front cooking station with placement shelf for table-top cooking units			
Basic equipment	<ul style="list-style-type: none"> - Extraction bridge with flame arrestor grease filters (correspond to Class A, DIN 18869-5) - Electronic control with filter change indicator - 3 power steps for need-oriented extraction - Air nozzles for fume-guiding air stream along the unit placement niche (on three sides) - Mains connection cable (approx. 4 m) - Removable placement shelf with max. load of approx. 150 kg - Free usable space below the device placement shelf 			
Height of underframe	900 mm			
Protection type	IP X4 with fan removed			
Castor model	Solid synthetic castors, 75 mm dia., 8 steering castors, 2 of which have brakes			
Material	Stainless steel (AISI 304)			
Model	BC FS 2	BC FS 3	BC FS 3 BHG	BC FS 4
Equipment	see basic equipment	see basic equipment	see basic equipment, lighting, closed sneeze guard and railing	see basic equipment, closed sneeze guard
Number of cooking units with max. dimensions (L x W x H)	for 2 table-top cooking units 400 x 650 x 300 mm	for 3 table-top cooking units 400 x 650 x 300 mm		for 4 table-top cooking units 400 x 650 x 300 mm
Placement niche dim. (L x W x H)	806 x 648 x 300 mm	1211 x 648 x 300 mm		1616 x 648 x 300 mm
Free usable space below placement shelf (L x W x H)	830 x 648 x 575 mm	1235 x 648 x 575 mm		1640 x 648 x 575 mm
Socket outlets (max. power consumption)	2 x 230 V Schuko socket outlets, 2 x 400 V CEE socket outlets (max. 10 kW)	3 x 230 V Schuko socket outlets, 3 x 400 V CEE socket outlets (max. 20 kW)		4 x 230 V Schuko socket outlets, 4 x 400 V CEE socket outlets (max. 20 kW)
Plug	16 A CEE plug	32 A CEE plug		32 A CEE plug
Connected load	400 V, 50/60 Hz, 3N PE	400 V, 50/60 Hz, 3N PE		400 V, 50/60 Hz, 3N PE
Output	10.8 kW	20.8 kW		20.8 kW
Exterior dim. (L x W x H)	1538 x 750 x 1361 mm	1943 x 750 x 1361 mm		2348 x 750 x 1361 mm
Order No.	573 973	573 974	573 975	573 976

OPTIONS FOR BC FS FRONT COOKING STATION

Option	Designation	For models
Connected load	16 A CEE plug, 400 V, 50/60 Hz, 3N PE, 10.8 kW	BC FS 3
	32 A CEE plug, 400 V, 50/60 Hz, 3N PE, 20.8 kW	BC FS 2
	63 A CEE plug, 400 V, 50/60 Hz, 3N PE, 40.8 kW	BC FS 4
Additional socket outlets	2 x 230 V Schuko socket outlets, in the usable space below the placement shelf, located both on the right and the left	All BC FS
Electrostatic filtering ION TEC	for improved filtering and reduction of odour particles and blue smoke, increases the service life of the activated charcoal filters	All BC FS
Lighting	placed above the cooking units with 5 LED spots, 20 W	BC FS 2
	with 7 LED spots, 28 W	BC FS 3
	with 9 LED spots, 36 W	BC FS 4
Sneeze guard	made of safety glass (ESG) closed to customer side, can be folded up for cleaning	All BC FS
Railing	made of stainless-steel round tube, on the customer and short sides	All BC FS
Tray slide	made of stainless-steel round tube, on the customer side, fold-down height 885 mm for castor diameter of 75 mm, corresponds to the normal height of the BASIC LINE tray slide	All BC FS
	made of stainless-steel round tube, on the customer side, fold-down height 850 mm for castor diameter of 75 mm, corresponds to the height of the MANHATTAN tray slide	All BC FS
Panelling	made of HPL (High Pressure Laminate), material thickness: 4 mm, colour: FunderMax 0077-FH, other colours on request, on the customer or short side	All BC FS
Base bottom	made of stainless steel, removable, maximum load: 80 kg	All BC FS
Stainless-steel castors	8 steering castors, 2 of which have brakes, 125 mm dia., total height is increased by 60 mm, height of the underframe is then 960 mm	All BC FS
Feet	made of stainless steel	All BC FS
Skirting panels	made of stainless steel, on the customer and short sides	All BC FS

ACCESSORIES FOR BC FS FRONT COOKING STATION

Illustration	Model	Designation	Dimensions W x D x H (mm)	Output/ connected load	Order No.	
	KTE 2-462	Underframe cooling table, 2 hinged doors, 2 height-adjustable support ledges for Gastronorm containers (max. 2 x GN 1/1), for rolling into BC FS 3, BC FS 4	1190 x 654 x 564 mm	220 – 240 V 1N PE 16 A 50 Hz 0.265 kW	370 396	
		Instead of a door, two full extensions one on top of the other (usable height of 135 mm each)				
		GN grate GR 1/1, made of stainless steel				550 267
		GN grate, Rilsan-coated, GRR 1/1				550 269
Illustration	Model	Designation		For models	Order No.	
	Transport dolly BC ROL 6x4	for rolling a BLANCOTHERM 420 into the free usable space, synthetic castors, 4 steering castors, 2 of which have brakes, 50 mm dia.		All BC FS	573 570	
	Multi-frame with bracket	made of stainless steel for operator side mounting to the odour filter boxes, for holding a GN 1/3 or its subdivision, including bracket for holding a roll of paper towels		All BC FS	573 977	
		Shelf made of glass for insertion into the multi-frame as additional storage surface		Multi-frame	573 978	
	Drawer rail set	consisting of two rails for holding a GN 1/1, to be mounted on the underside of the unit placement shelf		All BC FS	573 979	

BLANCO COOK INDUCTION HOBS AND INDUCTION WOKS



Model	Induction hob			Induction wok		
Basic unit equipment	<ul style="list-style-type: none"> - Flat Ceran surface - Microprocessor-controlled high-performance induction generator made by E.G.O. - Continuous power adjustment with rotary knob - Indicator light to display operating mode and error code in the event of faults - High efficiency - Air filter on unit base - Height-adjustable rotating feet - Mains connection cable (1.5 m) 					
Exterior dimensions (L x W x H)	620 x 400 x 240 mm					
Protection type	IP X4					
Accessories	See Page 543					
Material	<ul style="list-style-type: none"> - Stainless steel (AISI 304) with micro-polished surface - Ceran® (6 mm thick) 					
Model	BC IH 3500	BC IH 5000	BC IH 2Z 5000 2-zone induction hob	BC SIH 5000 Surface induction hob	BC IW 3500	BC IW 5000
Model	Induction hob with a round cooking zone Automatic pot detection from 120 mm dia.		Induction hob with two round cooking zones Automatic pot detection from 120 mm dia. 2 separately adjustable heating zones (2 coils, each with 220 mm dia.)	Induction hob with a rectangular cooking zone Automatic pot detection from 120 mm dia. 1 heating zone (2 coils, each measuring 220 x 220 mm)	Induction wok with a cuvette made of Ceran®	
Usable area (L x W)	564 x 339 mm Cooking zone 220 mm dia.		564 x 339 mm 2 cooking zones, each with 220 mm dia.	564 x 339 mm Cooking zone 220 x 447 mm	Cuvette 300 mm dia.	
Plug	Schuko plug	16 A CEE plug	16 A CEE plug		Schuko plug	16 A CEE plug
Connected load	220 – 240 V, 50 – 60 Hz 1N PE, 16 A	400 V, 50 – 60 Hz 3N PE, 16 A	400 V, 50 – 60 Hz 3N PE, 16 A		220 – 240 V, 50 – 60 Hz 1N PE, 16 A	400 V, 50 – 60 Hz 3N PE, 16 A
Output	3.5 kW	5.0 kW	2 x 2.5 kW (5 kW)	5.0 kW (2 x 2.5 kW)	3.5 kW	5.0 kW
Weight	19 kg	19 kg	27 kg	27 kg	18 kg	18 kg
Order No.	574 197	574 198	574 199	574 200	574 201	574 202

BLANCO COOK GRIDDLES



Model	Griddle, flat		Griddle, ribbed		
Basic unit equipment	<ul style="list-style-type: none"> - All-round seamlessly welded griddle surface with rounded corners for optimal cleaning and hygiene - Trough depth 30 mm - 15 mm-thick griddle for optimal temperature storage - Extremely powerful up to +250 °C - Even, full-surface heat distribution through tubular heating elements - Unheated resting zone (70 mm) on operator side - Drain opening incl. grease drain plug made of Teflon - Large, removable grease catch tray, capacity 1.6 litres - Continuous temperature adjustment with rotary knobs - 2 indicator lights to display operating mode and heating phase - Height-adjustable rotating feet - Mains connection cable (1.5 m) 				
Temp. range	+80 °C to +250 °C				
Protection type	IP X4				
Accessories	See Page 543				
Material	<ul style="list-style-type: none"> - Stainless steel (AISI 304) with micro-polished surface - Grilling surface made of tempered, corrosion-resistant chrome steel (Material No. 1.2316) 				
Model	BC GF 3500	BC GF 4200	BC GF 8400	BC GR 3500	BC GR 4200
Model	Griddle with straight, flat surface/grilling surface			Griddle with straight, ribbed surface/grilling surface	
			2 separately adjustable heating zones		
Exterior dimensions (L x W x H)	620 x 400 x 240 mm		620 x 800 x 240 mm	620 x 400 x 240 mm	
Usable area (L x W)	506 x 304 mm (of which 435 x 304 mm heated)		506 x 704 mm (of which 435 x 704 mm is heated)	506 x 304 mm (of which 435 x 304 mm heated)	
Plug	Schuko plug	16 A CEE plug	16 A CEE plug	Schuko plug	16 A CEE plug
Электроподключение	220 – 240 V, 50 – 60 Hz 1N PE, 16 A	400 V, 50 – 60 Hz 3N PE, 16 A	400 V, 50 – 60 Hz 3N PE, 16 A	220 – 240 V, 50 – 60 Hz 1N PE, 16 A	400 V, 50 – 60 Hz 3N PE, 16 A
Output	3.5 kW	4.2 kW	8.4 kW (2 x 4.2 kW per heating zone)	3.5 kW	4.2 kW
Weight	34 kg		69 kg	31 kg	
Order No.	574 203	574 204	574 205	574 206	574 207

BLANCO COOK DEEP GRIDDLE, PASTA COOKER, DEEP FRYER



Shown with accessories:

Model	Deep griddle BC DG 4200	Pasta cooker BC PC 4800	Deep fryer BC DF 5000
Model	<ul style="list-style-type: none"> - All-round seamlessly welded griddle surface with rounded corners for optimal cleaning and hygiene - Trough depth 65 mm - 15 mm-thick griddle for optimal temperature storage - Extremely powerful up to +250 °C - Even, full-surface heat distribution through tubular heating elements - Unheated resting zone (70 mm) on operator side - Drain opening incl. grease drain plug made of Teflon 	<ul style="list-style-type: none"> - Seamlessly deep-drawn basin with large corner radii - Deep basin for holding Gastronorm containers or pasta baskets up to 150 mm deep - Short heat-up time through external special heating element 	<ul style="list-style-type: none"> - Seamlessly deep-drawn basin with large corner radii - Cold zone at the bottom of the basin - Swivelling, interior heating element - Hanger for deep-frying baskets - Incl. lid to cover the frying basin
	<ul style="list-style-type: none"> - Continuous temperature adjustment with rotary knobs - 2 indicator lights to display operating mode and heating phase - Height-adjustable rotating feet - Mains connection cable (1.5 m) 		
Exterior dimensions (L x W x H)	620 x 400 x 240 mm		
Protection type	IP X4		
Accessories	See Page 543		
Material	<ul style="list-style-type: none"> - Stainless steel (AISI 304) with micro-polished surface - Grilling surface made of tempered, corrosion-resistant chrome steel (Material No. 1.2316) 	<ul style="list-style-type: none"> - Stainless steel (AISI 304) with micro-polished surface - Basin made of corrosion-resistant V4A steel (Material No. 1.4404) 	<ul style="list-style-type: none"> - Stainless steel (AISI 304) with micro-polished surface
Capacity	7 litres	20 litres	min. 5 litres, max. 6.5 litres
Drain	Safety drain with clamp screw, drain plug made of Teflon for basin	Safety drain valve	Safety drain valve
Usable area (L x W)	506 x 304 mm	509 x 304 mm	346 x 238 mm
Temp. range	+80 °C to +250 °C	+45 °C to +100 °C	+100 °C to +180 °C
Plug	16 A CEE plug	16 A CEE plug	16 A CEE plug
Connected load	400 V, 50 – 60 Hz 3N PE, 16 A	400 V, 50 – 60 Hz 3N PE, 16 A	400 V, 50 – 60 Hz 3N PE, 16 A
Output	4.2 kW	4.8 kW	5.0 kW
Weight	33 kg	14 kg	16 kg
Order No.	574 208	574 210	574 211

BLANCO COOK CERAN® HOB, BAIN-MARIE, HOT PLATE, MULTI-ELEMENT



Shown with accessories:
GN containers

Model	Ceran® hob BC CH 4300	Bain-marie BC BM 700	Hot plate BC HP 700	BC ME multi-element
Model	<ul style="list-style-type: none"> - Ceran® hob (6 mm thick) with radiant heaters and 2 round cooking zones - 2 radiant heaters (1.8 kW and 2.5 kW) - Indicator lights to display operating mode - Continuous temperature adjustment per cooking zone via rotary knob 	<ul style="list-style-type: none"> - Seamlessly deep-drawn basin with large corner radii and external heating - Deep basin for holding Gastronorm containers up to 150 mm deep - 2 indicator lights to display operating mode and heating phase - Continuous temperature adjustment with rotary knob 	<ul style="list-style-type: none"> - Hot plate with thermally separated heat-retaining area - Silicone-sealed, 3 mm-thick heat-retaining surface made of stainless steel - 2 indicator lights to display operating mode and heating phase - Continuous temperature adjustment with rotary knob 	<ul style="list-style-type: none"> - Open element at top and front for hooking or sliding in GN containers and GN trays - Easy cleaning thanks to one-piece flat surfaces - Can be cleaned in a dishwasher (without feet)
	Mains connection cable (1.5 m)			
	Height-adjustable rotating feet			Height-adjustable rotating feet
Exterior dimensions (L x W x H)	620 x 400 x 240 mm	620 x 400 x 240 mm	620 x 400 x 240 mm	620 x 400 x 240 mm
Protection type	IP X4	IP X4	IP X4	--
Accessories	See Page 543			See Page 543
Material	- Stainless steel (AISI 304) with micro-polished surface	- Stainless steel (AISI 304) with micro-polished surface - Basin made of corrosion-resistant V4A steel (Material No. 1.4404)	- Stainless steel (AISI 304) with micro-polished surface	- Stainless steel (AISI 304) with micro-polished surface
Capacity	--	max. 1x GN 1/1-150	--	Top: max. of GN 1/1-150 (depending on depth of container located below) Bottom: max. of GN 1/1-100
Usable area (L x W)	564 x 339 mm Cooking zone 170 mm dia. and 220 mm dia.	509 x 304 mm	565 x 340 mm	--
Temp. range	--	+45 °C to +95 °C	+55 °C to +120 °C	--
Plug	16 A CEE plug	Schuko plug	Schuko plug	--
Connected load	400 V, 50 – 60 Hz 3N PE, 16 A	220 – 240 V, 50 – 60 Hz 1N PE, 16 A	220 – 240 V, 50 – 60 Hz 1N PE, 16 A	--
Output	4.3 kW	0.7 kW	0.7 kW	--
Weight	12 kg	15.5 kg	18 kg	7 kg
Order No.	574 209	574 212	574 213	573 458

ACCESSORIES FOR TABLE-TOP COOKING UNITS

Illustration	Designation	For model	Order No.
	Ceran® cleaning scraper	For BC IH induction hob, BC CH Ceran® hob	568 489
	Round-bottom wok made of stainless steel, 360 mm dia., max. capacity 5.5 litres, weight 1.2 kg	For BC PC pasta cooker	573 513
	Pasta basket set , consisting of 6 baskets: approx. GN 1/6-100, each with insulated handles and insertion frames	For BC PC pasta cooker	574 254
	Pasta basket set , consisting of 2 baskets: approx. GN 1/3-100 and 2 baskets: approx. GN 1/6-100, each with insulated handles and insertion frames	For BC PC pasta cooker	574 255
	Gastronorm G-KEN G 1/1-95 cooking insert perforated, with folding handles	For BC PC pasta cooker	550 971
	Lid with handle, GD 1/1 for covering	For BC DG deep griddle, for BC GF griddle, flat	550 658
	Grill cleaning scraper, flat	For BC GR griddle, ribbed	573 252
not shown	Grill cleaning scraper, ribbed	For BC GR griddle, ribbed	574 306
	Splash guard	For BC GF and and BC GR griddles (except BC GF 8400)	574 256
	Splash guard	For BC GF 8400 griddle	574 257
not shown	BLANCO COOK non-stick care 500 ml, maintains and protects the griddle surface and provides improved non-stick performance	For griddles and deep griddles	574 302
	Deep-frying basket set (2 pcs.), with insulated handles 260 x 95 mm each	For BC DF deep fryer	574 258
	Deep-frying basket with insulated handle 260 x 220 mm	For BC DF deep fryer	574 259
	Clamping bar made of stainless steel for covering the gap between two BLANCO COOK table-top cooking units	For all models	574 298



BLANCO COOK

Front cooking system for professionals: Mobile technology for successful show cooking in front of guests.





Storage





Cam GoBox™ – Insulated Carrier Line

Cambro's latest line of insulated transporters are ideal for caterers and foodservice operators looking for an ultra-lightweight transporter that offers superior temperature retention to protect food safety and excellent durability to withstand heavy commercial use, all at a budget friendly price. Just take them and go!

- Thermal Insulation- Holds hot or cold food for many hours.
- Lightweight- Made of EPP (Expanded Polypropylene)- an eco-friendly, high-performance foam material.
- Great Structural Strengthcapable of handling significant loads while maintaining its shape and form.
- Excellent Energy Absorption- can withstand substantial impact without damage.
- Chemically Inert- unaffected by oil, grease, and most chemicals.
- Dishwasher safe.
- CFC-Free.
- 100% Recyclable.
- Line your Cam GoBox with a Cambro GN Food Pan and Seal Cover for the ultimate food safety solution. Cambro GN pans protect food and carrier to support HACCP compliance.

Cam GoBox™ – Insulated Carrier Line



Using Cam GoBox carriers together with Cambro's polycarbonate, polypropylene or high heat GN food pans creates the ideal food-safe, HACCP-compliant holding and transport system.

Hot Holding

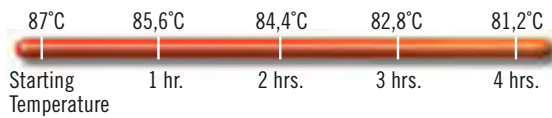

Cold Holding

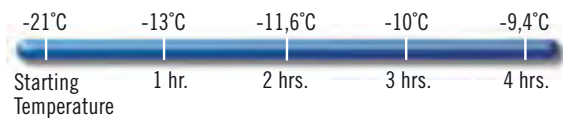

Ergonomic Handles

Comfortable handles allow easy and safe lifting of the Cam GoBox.



Stackability

Cam GoBoxes inter-stack and also stack with major competitive brands.



Easy Identification

A built-in label area keeps plastic menu tags (included for EPP300 and EPP400) in place for easy content identification or routing. StoreSafe Labels can also be used with Cam GoBoxes.



Easy Loading and Unloading

Interior wall recesses make loading and unloading easy for both GN 1/1 as well as 1/2 pans.



4-Sided Handling

Thoughtfully designed built-in handles along the top of the front loader units allow them to be easily carried from all four sides.



Drip-Resistant

Built-in condensation barrier helps front loaders to remain drip-resistant.



Gentle Open and Close

Beveled door edges ensure door can be easily closed and latched.



Full 270° Access

Durable hinges and latches allow the door to open 270° and remain open securely to the side of the front loader for easy access to products. Latches keep door securely closed during transport.

Cam GoBox™ – Insulated Carrier Line



PRODUCT CODE	4122600	4122601	4122602
CAMBRO CODE	EPP160	EPP180	EPP180S
DESCRIPTION (CM)	Top Loader for 15 cm GN pan	Top Loader for 20 cm GN pan	Stacking Top Loader for 20 cm GN pan
EXTERIOR DIM. L x W x H	60 x 40 x 25,7	60 x 40 x 31,6	60 x 40 x 18,2 (top) 58,6 x 33,6 x 10 (bottom)16 pans
INTERIOR DIM. L x W x H	53,8 x 33,8 x 19,3	53,8 x 33,8 x 25,3	53,8 x 33,8 x 15,9 (top) 50,4 x 30,2 x 9,5 (bottom)
UNIT WEIGHT	1,07 kg	1,2 kg	1,13 kg
VOLUME	35,5 L	46 L	43 L

Case Pack: 1 Color: Black (110).



For GN 1/2 Size pan



EPP 260
for 15 cm pan

EPP 280
for 20 cm pan

PRODUCT CODE	4122603	4122604	4122605	4122606
CAMBRO CODE	EPP300	EPP400	EPP260	EPP280
DESCRIPTION	Front Loader	Front Loader	Top Loader	Top Loader
EXTERIOR DIM. L x W x H	64,5 x 44 x 47,5 cm	64,5 x 44 x 63 cm	39 x 33 x 25,7 cm	39 x 33 x 31,6 cm
INTERIOR DIM. L x W x H	53,5 x 33 x 37 cm	53,5 x 33 x 52,5 cm	33 x 27 x 19,3 cm	33 x 27 x 25,3 cm
UNIT WEIGHT	3,2 kg	3,9 kg	0,62 kg	0,7 kg
VOLUME	60 L	86 L	16,9 L	22,3 L

Case Pack: 1 Color: Black (110).

Optional Accessories



PRODUCT CODE	4122700	4122701	4122702	4122703	4122704
CAMBRO CODE	CP3253	HP3253	EPP3253DIV	CD3253EPP	EPPID5
DESCRIPTION (CM)	Camchiller® GN 1/1 fits all Cam GoBoxes	Camwarmer® GN 1/1 fits all Cam GoBoxes	ThermoBarrier® fits EPP300 & EPP400	Camdolly® fits all Cam GoBoxes	Plastic ID labels fits all Cam GoBoxes
EXTERIOR DIM. L x W x H	53 x 32,5 x 3 cm	53 x 32,5 x 3 cm	53 x 32,7 x 3,7 cm	—	—
UNIT WEIGHT	3,9 kg	3,25 kg	0,37 kg	4,5 kg	—
COLOUR	Cold Blue (159)	Hot Red (158)	Black (110)	Hot Red (158)	(000)

Case Pack: 1.

Cam GoBox™ Capacity Guide

All Cam GoBox carriers are designed with enough room to hold GN 1/1 pans along with Camwarmers or Camchillers, if desired.

Top Loaders

EPP160

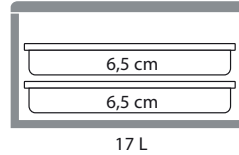
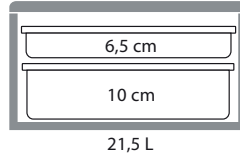
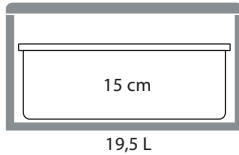

EPP180

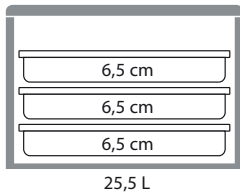
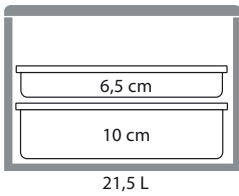
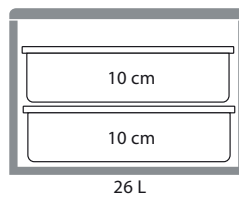
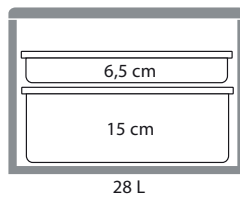
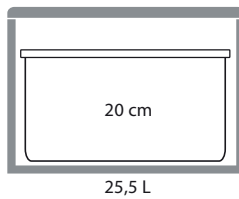

EPP180S

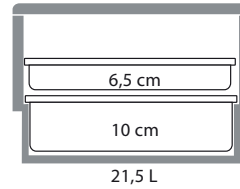
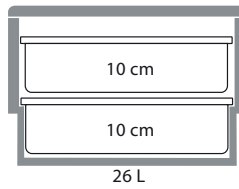
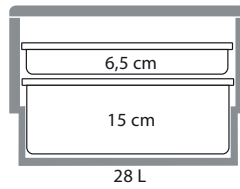
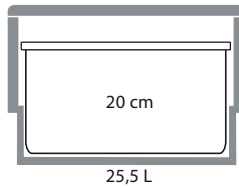

Front Loaders

EPP300

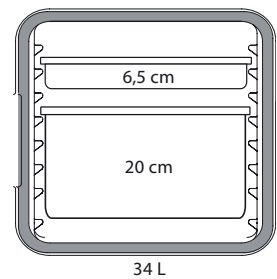
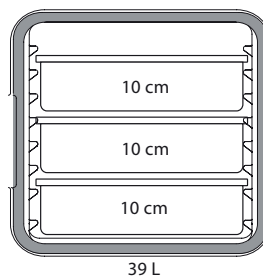
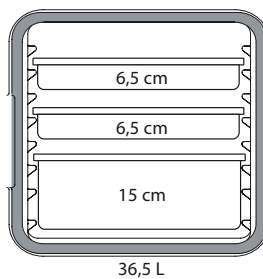
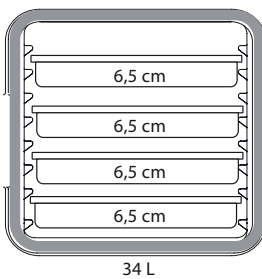

EPP400

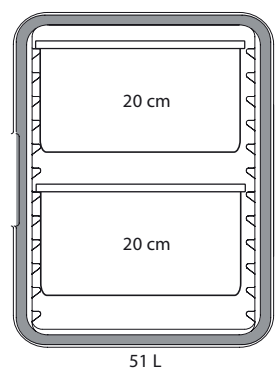
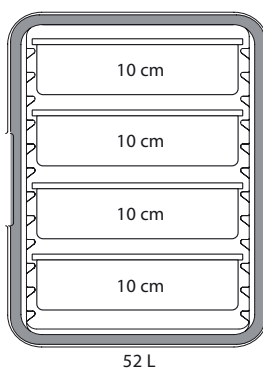
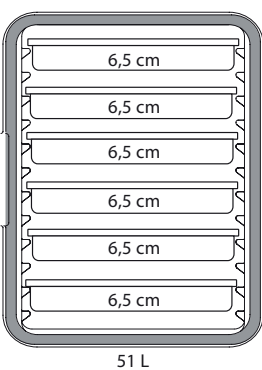

Ultra CamCart for Gastronorm Pan Transportation (Non-Electric) 大型保温车

Multiple GN Food Pan, Front-Loading Carts

- Double-compartment, high capacity carts hold and transport hot or cold food.
- Tough, polyethylene shell and thick foam insulation throughout cabinet and between compartments maintain safe food temperatures for 4 hours or more.
- Easy to maintain and won't dent, crack, rust, or chip.
- Durable nylon door latches open easily and close securely.
- Full-swing doors open to the side of the cart for easy loading and unloading.
- Airtight removable gaskets
- Molded-in handles ensure easy maneuvering.
- Molded-in bumpers minimize damage to walls, furniture and other equipment.



Polyurethane insulation keeps hot food hot and cold food cold.



UPC600



UPC800

PRODUCT CODE	4122201-XX	4122202-XX
CAMBRO CODE	UPC600	UPC800
DESCRIPTION	Hold 8 x GN1/1 x 2.5" Pan	Hold 12 x GN1/1 x 2.5" pan
COMP DIA (w x d x h cm)	34 x 54 x 35.5	33 x 54 x 48.5
OVERALL DIA (w x d x h cm)	52 x 69 x 114.5	52 x 69 x 137



UPC1200



UPC1600

PRODUCT CODE	4122203-XX	4122204-XX
CAMBRO CODE	UPC1200	UPC1600
DESCRIPTION	Hold 16 x GN1/1 x 2.5" Pan	Hold 24 x GN1/1 x 2.5" pan
COMP DIA (w x d x h cm)	54 x 66.5 x 34.5	53.5 x 66.5 x 53.5
OVERALL DIA (w x d x h cm)	72.5 x 82 x 116	71.5 x 82 x 135

*Available Colour

■ BK (black) ■ GNGY (granite grey) ■ DBR (dark brown)

When ordering Black Colour add **CODE** suffix to item number (example: 9122203-BK)

Ultra Pan Carrier for GN Pan (Non Electric) 保温箱

Ultra Pan Carrier® UPC400

Ultra Pan Carrier® S-Series UPC400

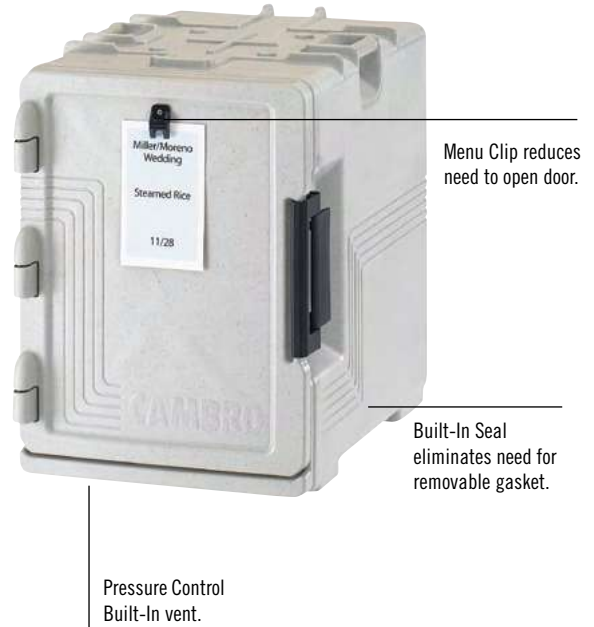

	UPC400	UPCS400
PRODUCT CODE	4122200-XX	4122300-XX
CAMBRO CODE	UPC400	UPCS400
DESCRIPTION	Hold 6 x GN1/1 x 2.5" Pan	Hold 6 x GN1/1 x 2.5" pan
COMP DIA (w x d x h cm)	33.5 x 53.3 x 49	33 x 53.5 x 48.6
OVERALL DIA (w x d x h cm)	46 x 63.3 x 62	46 x 63.5 x 63

*Available Colour

■ BK (black) ■ DBR (dark brown)

When ordering Black Colour add **CODE** suffix to item number (example: 4122200-BK)

*Available Colour

■ BK (black) ■ SPGY (speckled grey)

When ordering Black Colour add **CODE** suffix to item number (example: 4122300-BK)

Full Size Food Pan Holding Capacity UPC400 / UPCS400

Also hold 1/2 & 1/3 size pans

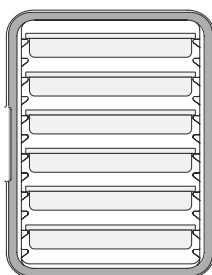

6 x 2.5" (6.5cm)

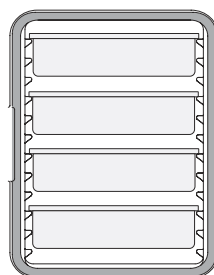

4 x 4" (10cm)

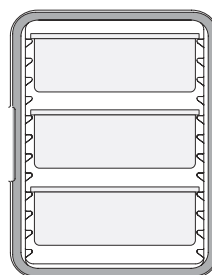

3 x 6" (15cm)

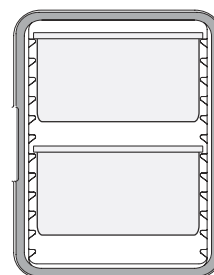

2 x 8" (20cm)

Electric Heated Ultra GN Pan Carrier & Ultra Camcart 加热大型保温车

- Designed for both electric hot holding and non-electric transport.
- Gentle, 150° to 165°F non-radiant heat will not cook food and maintains food moisture.
- Holds a wide variety of foods such as pasta, bone-in fried chicken, and double-crustured pies.
- One hour preheat time from room temperature and three minute recovery.
- Energy consumption is substantially less than comparable metal cabinets.
- Will not rust or dent like metal cabinets, is more economical, and is easy to maneuver.
- All UPCH models have been tested to maintain at safe, hot food temperatures, for up to 4 hours when unplugged.
- Models with only the top heated door offer unique versatility with an electric hot holding cabinet on top and passive hot or cold food holding on the bottom.



Power On and Heat On Indicators

Communicate the Power and Heating status of the UPCH1600 unit. Know instantly when the compartment has reached target temperature.



Vents

Consistent heating throughout the compartment is generated by vents that constantly circulate heat from front to back.



Tough Exterior

All UPCH units are made of tough polyethylene with polyurethane foam insulation to keep heat in while keeping the exterior cool to the touch. Will not crack, dent, chip, rust or break.



Insulation

CFC-free, foamed-in place polyurethane foam insulation will hold temperature above 148°F for up to 4 hours when used unplugged.



UPCH4002

UPCH8002

UPCH16002

PRODUCT CODE	4123300-XX	4123301-XX	4123302-XX
CAMBRO CODE	UPCH4002	UPCH8002	UPCH16002
VOLTAGE / CYCLE	230V / 50-60Hz	230V / 50-60Hz	230V / 50-60Hz
WATTS / AMPS	265W / 1.2A	265W / 1.2A	506W / 2.3A
DESCRIPTION	Hold 6 x GN1/1 x 2.5" Pan	Hold 12 x GN1/1 x 2.5" Pan	Hold 24 x GN1/1 x 2.5" Pan
COMP DIA (w x d x h cm)	33.5 x 53.3 x 48.6	33 x 54.5 x 48.5	53 x 66.5 x 53.5
OVERALL DIA (w x d x h cm)	46 x 67 x 63	52 x 69 x 137.2	73 x 84.7 x 137.5
CASTORS TYPE / DOLLY USE	Use CD400 For Dolly	15.2cm: 2 Fixed, 2 Swivel, 1with Brakes for both model.	
POWER CORD LENGTH	2.7 metre	2.7 metre	2.7 metre

*Available Colour

■ BK (black) ■ DBR (dark brown) ■ GNGY (granite grey)

When ordering Black Colour add **CODE** suffix to item number (example: 4123300-BK)

Insulated Top Loading CamCarrier S-Series

- Top-loading food pan carriers hold, transport and serve a single full-size pan of hot or cold food.
- Sturdy and durable, seamless polyethylene or polypropylene with thick foam insulation.
- Molded-in handles on all four sides for easy carrying and handling.
- Use with divider bars to hold multiple fractional pans.
- Pans are easy to remove using finger notches.
- Carriers interlock and stack for transporting and storing.



	UPCS140	UPCS160	UPCS180
PRODUCT CODE	4122100-XX	4122101-XX	4122102-XX
CAMBRO CODE	UPCS140	UPCS160	UPCS180
DESCRIPTION	Hold 1 x GN1/1 x 4" Pan	Hold 1 x GN1/1 x 6" pan	Hold 1 x GN1/1 x 8" pan
COMP DIA (w x d x h cm)	64 x 43.5 x 22	64 x 43.5 x 26	64 x 43.5 x 30.5

*Available Colour

■ DBR (dark brown) ■ SPGY (speckled grey)

When ordering Black Colour add **CODE** suffix to item number (example: 4122100-DBR)

Camdollies® / Camchiller® / Camwarmer® & Thermobarrier®

*Available Colour

■ DBR (dark brown) ■ BK (black)

When ordering Black Colour add **CODE** suffix to item number (example: 4122401-BK)



	CD160	CD400
PRODUCT CODE	4122401-XX	4122400-XX
CAMBRO CODE	CD160	CD400
LOAD CAPACITY	136 kg	136 kg
INTERNAL DIA (w x d cm)	36 x 56	46 x 63.5
OVERALL DIA (w x d x h cm)	49 x 65 x 26.5	53 x 70 x 23
CASTORS TYPE	12.7 cm: 2 fixed, 2 swivel, 1 with brake	12.7 cm: 2 fixed, 2 swivel, 1 with brake
HOLD	UPCS140, UPCS160, UPCS180	UPC400, UPCS400, UPCH4002

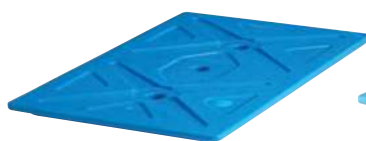

	CP1220	CD1210	1210PW
PRODUCT CODE	4123100	4123101	4123102
CAMBRO CODE	CP1220	CP1210	1210PW
TYPE	1/1 Size	1/2 Size	-
DIMENSION (w x d x h cm)	53 x 33 x 3.8	32.4 x 26.4 x 3.8	34 x 27.5 x 4
FIT FOR	UPC400, UPCS400, UPC600, UPC800, UPC1200, UPC1600, all Combo Cart® Plus and CamKiosks	UPC400, UPCS400, UPC600, UPC800, UPCS140, UPCS160, UPCS180 & all CamKiosks	UPC600, UPC800

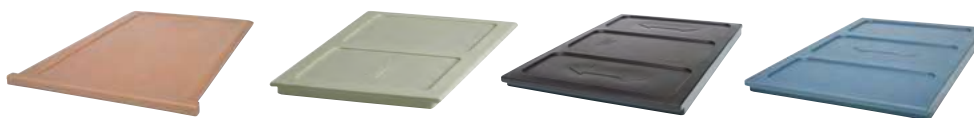

	300DIV	400DIV	1200DIV	1600DIV
PRODUCT CODE	4122800	4122801	4122802	4122803
CAMBRO CODE	300DIV	400DIV	1200DIV	1600DIV
OVERALL DIA (l x w x h cm)	53 x 33 x 2.5	54 x 33 x 2.5	53 x 33 x 3.5	53 x 33 x 3.8
FIT FOR	UPC600	UPC800	UPC1200	UPC1600
COLOUR AVAILABLE	Coffee Beige	Grey	Dark Brown	Slate Blue

Insulated Camcarts for 45 x 66 cm (18" x 26") Trays / Sheet Pans

- Use to hold hot or cold bulk food stored on trays, sheet pans or in food boxes.
- Durable polyethylene and thick foam insulation retain safe food temperatures.
- Sturdy plastic, rust-proof latches are secured into molded-in mounting plates.
- Molded-in handle on the back for easy maneuvering.



	1826LTC	1826DTC
PRODUCT CODE	4123500-XX	4123501-XX
CAMBRO CODE	1826LTC	1826DTC
DESCRIPTION	Hold 13 x 46 x 66cm Tray / Sheet Pan	Hold 24 x 46 x 66cm Tray / Sheet Pan
COMP DIA (w x d x h cm)	46 x 66.4 x 66.7	46.4 x 67.3 x 64.6
OVERALL DIA (w x d x h cm)	55 x 81.5 x 95.5	55 x 84.5 x 162
CASTORS TYPE	15.2cm: 2 Fixed, 2 Swivel, 1with Brakes	15.2cm: 2 Fixed, 2 Swivel, 1with Brakes
ADDITIONAL INFORMATION	Complete with 1 removable cutting Board on top Space between rails: 4.92cm, 13 rails	Space between rails: 4.92cm, 12 rails per compt

*Available Colour

■ DBR (dark brown) ■ GNGY (granite grey)

When ordering Dark Brown Colour add **CODE** suffix to item number (example: 4123500-DBR)

Combo Cart™ Plus (Non Electric) 综合食品车

- The most versatile insulated transporter on the market! Holds food pans, sheet pans, trays and even large pizza boxes.
- Two separate compartments offer the flexibility of holding either hot or cold food.
- Tough, durable polyethylene exterior will not dent, rust or chip a great alternative to metal holding carts!
- Thick, CFC-free polyurethane insulation throughout the cabinet ensures excellent food quality and temperature retention for 4 or more hours.
- Ideal for caterers, schools, hotels and large institutions.



STAINLESS STEEL UNIVERSAL RAILS*
Holds sheet pans, food pans, pizza boxes and trays (or limitless combinations of these!)
*7 pairs/compartment

MARINE RAILING
Creates a bonus staging area for food pans.



ERGONOMIC VERTICAL MOLDED-IN HANDLES
Will never break; great for maneuvering by operators of all heights.

GASKET-FREE DOOR
Worry free door! Swings open completely to the side.

MENU POCKET
Allows for easy product ID with either an index card or by writing directly onto smooth surface with a grease pencil.

WIDE PADDLE LATCHES
For easy opening and closing.



CASTERS
All swivel with brakes for smooth positioning and navigation; non-marking.

PERIMETER BUMPER
Protects cart and walls.



INSULATION
CFC-free, polyurethane insulation throughout the body and doors maximizes heat or cold retention for 4 hours or more.

	CMBPL	CMBP
PRODUCT CODE	4122900	4122901
CAMBRO CODE	CMBP	CMBP
DESCRIPTION	Low Model	Tall Model
COMP DIA (w x d x h cm)	53.7 x 66.7 x 64.8	53.7 x 66.7 x 64.8
OVERALL DIA (w x d x h cm)	70.2 x 85.1 x 104.5	70.2 x 85.1 x 167.3
CASTORS TYPE	15 x 3.2cm: all swivel with brakes	15 x 3.2cm: all swivel with brakes
HOLD	45 x 66cm (18" x 26") Sheet Pan, 33 x 5.7cm Sheet Pan, GN Pan, 40 x 60cm Baking Tray, 32.5 x 53cm Tray, 40.6 x 40.6 x 5.1cm PIZZA Box	

*Available Colours: Charcoal Grey

Holding Capacity Reference

TYPE OF PANS	STANDARD CAPACITY	RAIL SPACING	MAXIMUM CAPACITY	RAIL SPACING
45.7 x 66cm SHEET PANS	14	8.6 cm	32 (additional rails required)	3.8 cm
33 x 5.7cm SHEET PANS	28	8.6 cm	64 (additional rails required)	3.8 cm
GN 1/1 x 6.5cm PANS	28	8.6 cm	28	8.6 cm
GN 1/1 x 10cm PANS	20 (use 5-pairs of rails)	12.7 cm	20	12.7 cm
40 x 60cm TRAYS	14	8.6 cm	32 (additional rails required)	3.8 cm
32.5 x 53cm TRAYS	28	8.6 cm	52 (additional rails required)	4.8 cm
40.6 x 40.6 x 5.1cm PIZZA BOX	14	8.6 cm	22	5.7 cm

Combo Cart™ Plus (Electric)

电综合食品车

- The most versatile insulated transporter on the market! Holds food pans, sheet pans, trays and even large pizza boxes.
- Two separate compartments offer the flexibility of holding either hot or cold food by simply keeping it unplugged.
- Tough, durable polyethylene exterior will not dent, rust or chip and remains cool to the touch during operation - a great alternative to metal holding carts!
- Thick, CFC-free polyurethane insulation throughout the cabinet ensures excellent food quality and temperature retention for 4 hours or more, even when unplugged.
- Over 50% more energy-efficient, on average, than leading metal carts.
- Ideal for caterers, schools, hotels and large institutions.



STAINLESS STEEL UNIVERSAL RAILS

Holds sheet pans, food pans, pizza boxes and trays (or limitless combinations of these!)

ENERGY-SAVING HEATER

compared to leading metal carts! Gentle, non-radiant heat circulates consistently from front to back of the cabinet.



POWER ON AND HEAT ON INDICATORS

Communicate the power and heating status of the unit. Know instantly when the compartment has reached target temperature. Turn on and off without unplugging the cord.

GASKET-FREE DOOR

Worry free door! Swings open completely to the side.

MARINE RAILING

Creates a bonus staging area for food pans.



MENU POCKET

Allows for easy product ID with either an index card or by writing directly onto smooth surface with a grease pencil.

CASTERS

All swivel with brakes for smooth positioning and navigation; non-marking.

CORD KEEPER

Stores 9' (2,7 m) power cord neatly and safely.

PERIMETER BUMPER

Protects cart and walls.



ERGONOMIC VERTICAL MOLDED-IN HANDLES

Will never break; great for maneuvering by operators of all heights.

SOLAR DIGITAL THERMOMETER

Monitor internal cabinet temperature at a glance.

WIDE PADDLE LATCHES

For easy opening and closing.



INSULATION

CFC-free, polyurethane insulation throughout the body and doors maximizes heat or cold retention for 4 hours or more.



	CMBPLH	CMBPH
PRODUCT CODE	4123000	4123001
CAMBRO CODE	CMBPLH	CMBPH
VOLTAGE / CYCLE	230V / 50-60Hz	230V / 50-60Hz
WATTS / AMPS	506W / 2.3A	506W / 2.3A
COMP DIA (w x d x h cm)	53.7 x 66.7 x 64.8	53.7 x 66.7 x 64.8
OVERALL DIA (w x d x h cm)	70.2 x 85.1 x 104.5	70.2 x 85.1 x 167.3
CASTORS TYPE	15 x 3.2cm: all swivel with brakes	15 x 3.2cm: all swivel with brakes
POWER CORD LENGTH	2.7 metre	2.7 metre
HOLD	45 x 66cm (18"x 26") Sheet Pan, 33 x 5.7cm Sheet Pan, GN Pan, 40 x 60cm Baking Tray, 32.5 x 53cm Tray, 40.6 x 40.6 x 5.1cm PIZZA Box	

*Available Colours: Charcoal Grey



BLANCO
GERMANY

BLANCO BANQUET TROLLEY

Perfectly positioned for
immediate service

banquettrolley



Reliable, rugged, beautiful: BLANCO CS quality is unmistakable.

The banquet trolley family from BLANCO fulfils the highest demands of design, functionality and ergonomics.

Even its appearance is appetizing: With their timeless design and superior appearance, BLANCO banquet trolleys look good in any setting.

BLANCO banquet trolleys are not just aesthetically pleasing. Thanks to their temperature adjustment – right down to the nearest degree – and excellent insulating properties, they ensure the best possible food quality – even in case of longer waiting times.

Thus you and your food can put on an appetizing performance at all times, regardless of whether served ceremoniously on plates at banquets or in GN containers in food halls or for buffets.





8230118

Heated Banquet Trolley

宴会手推车 (热)

BW 18

Code	8230118
Power	2,200 watts
Voltage	220–240 V, /50–60 Hz
Heat-up time	approx. 15 min
Max No. GN container	18 GN 2/1-65
Max load capacity	200 kg
Dimension (l x d x h)	84.0 x 94.5 x 192 cm
Weight	146 kg

BW 36

Code	8230136
Power	2,200 watts
Voltage	220–240 V, /50–60 Hz
Heat-up time	approx. 15 min
Max No. GN container	Without dividing wall, no GN
Max load capacity	200 kg
Dimension (l x d x h)	139 x 94.5 x 192 cm
Weight	225 kg



8230136

- Push handles also accessible when the doors are open
- Door double-walled, insulated and thermally separated with all-round removable sealing profile
- Self-closing, 2-point lock secure for transport (with safety position), lockable
- Completely open doors can be locked
- Interior: HS hygienic type
- Protection type: IP X4



Cold Banquet Trolley

宴会手推车 (冷)

BW-UK 15

Code	8230215
Power	500 watts
Voltage	220–240 V, 50/60 Hz
Pre cooling time	(+25 °C to +2 °C) approx. 15 min
Max No. GN container	15 GN 2/1-65
Max load capacity	200 kg
Dimension (l x d x h)	84.0 x 94.5 x 192 cm
Weight	180 kg

- Can be regulated down to the degree from –10 °C to +8 °C
- Push handles also accessible when the doors are open
- Door double-walled, insulated and thermally separated with all-round removable sealing profile
- Self-closing, 2-point lock secure for transport (with safety position), lockable
- Completely open doors can be locked
- Interior: HS hygienic type
- Protection type: IP X4

BLANCOTHERM Heatable

宴会手推车 (冷)

BLT 1020 EB

Code	8230310
Power	380 watts
Voltage	220-240 V, 50-60 Hz
Heat up time	25 min
Capacity	GN containers up to max. 3 x GN 1/1-200 + 1 x GN 1/1-100
GN-container capacity	max. 92.8 L
Range of use	-20 °C to +100 °C
Heating & temperature	Convection heating, Temperature range: +30 °C to +90 °C, continuously adjustable
Dimension (l x d x h)	54.0 x 81.5 x 115 cm
Weight	66 kg



8230310

BLT 1220 EB

Code	8230320
Power	760 watts
Voltage	220-240 V, 50-60 Hz
Heat up time	25 min
Capacity	GN containers up to max. 5 x GN 1/1-200
GN-container capacity	max. 132.5 L
Range of use	-20 °C to +100 °C
Heating & temperature	Convection heating, Temperature range: +30 °C to +90 °C, continuously adjustable
Dimension (l x d x h)	54.0 x 81.5 x 149.5 cm
Weight	86 kg



8230320

BLT 820 EB

Code	8230330
Power	380 watts
Voltage	220-240 V, 50-60 Hz
Heat up time	25 min
Capacity	GN containers up to max. 3 x GN 1/1-200
GN-container capacity	max. 79.5 L
Range of use	-20 °C to +100 °C
Heating & temperature	Convection heating, Temperature range: +30 °C to +90 °C, continuously adjustable
Dimension (l x d x h)	54.0 x 81.5 x 97.7 cm
Weight	59 kg



8230330

Plate Dispenser Trolley

碗碟分配车

TS-H1 18-33

Code	8230401
Power	900 watts
Voltage	220-240 V, 50-60 Hz
Capacity	Approx. 80 plates
Range of use	+30 °C to +110 °C
Dimension (l x d x h)	68 x 52 x 103 cm
Weight	44 kg

TS-H2 18-33

Code	8230402
Power	1,200 watts
Voltage	220-240 V, 50-60 Hz
Capacity	Approx. 160 plates
Range of use	+30 °C to +110 °C
Dimension (l x d x h)	107.6 x 52 x 103 cm
Weight	69 kg





8240401



8240402

Electric Plate Warmer Cart 电保温碗碟推车

Single

Code	8240401
Power	400 watts
Voltage	220V, 50Hz
Fits	8 - 12 inch round plate
Capacity	Approx. 75 plates
Dimension (l x d x h)	45 x 48.5 x 77 cm
Weight	31 kg

Double

Code	8240402
Power	800 watts
Voltage	220V, 50Hz
Fits	8 - 12 inch round plate
Capacity	Approx. 150 plates
Dimension (l x d x h)	45 x 91 x 77 cm
Weight	48 kg



Heated Banquet Trolley 电热食物推车



Code	8240200
Power	2,000 watts
Voltage	230V, 50Hz
Temperature	50-80°C
Dimension (l x d x h)	91.0 x 82.7 x 181.6 cm
Weight	114 kg

- The convection-heated banquet trolleys can be used with dry or moist air, depending on what is best for your food.
- Digital control with cabinet temperature display and setting. Fully compliant with HACCP digital controls include visible alarms.
- Large storage area suitable to contain 2/1 GN containers or shelves on anti-tilt pressed runners.
- Optimized bottom to up forced air flow provides even temperature distribution and fast heating in any conditions.
- Cabinet fitted with up to 70 mm thickness of eco friendly polyurethane insulation for best insulating performance.
- Removable triple e-chamber ballon magnetic gasket to improve insulation and to reduce energy consumption.
- The gap on the sides-end ensures the circulation of the convection air to achieve even temperature inside the banquet trolley.
- The slide-in heating module can be removed easily.
- The water tank for the moist-air heating can also be removed conveniently.
- Manual water refilling

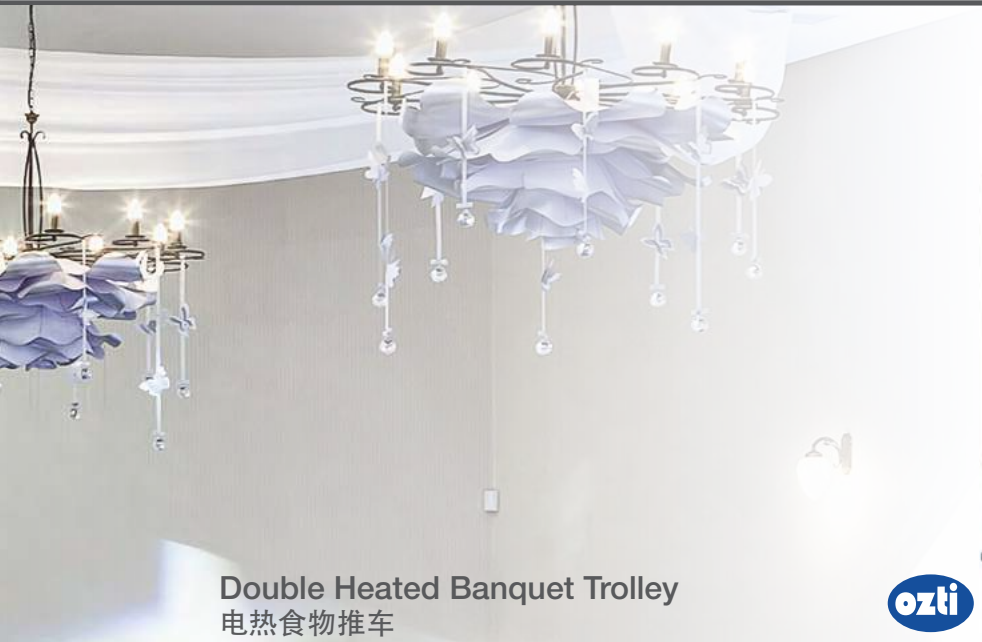

Double Heated Banquet Trolley 电热食物推车



Code	8240100
Power	2,000 watts
Voltage	230V, 50Hz
Temperature	50-80°C
Dimension (l x d x h)	91 x 151.7 x 181.6 cm
Weight	208 kg

- Complete stainless steel inner and outer body.
- Environment friendly insulation polyurethane injection at the density of 40-42 kg/m³
- Removable heating system



Cold Banquet Trolley 电冷食物推车



Code	8240300
Power	310 watts
Voltage	230V, 50Hz
Temperature	-2 / +8 °C
Capacity	500 L
Dimension (l x d x h)	91.0 x 85.0 x 187.2 cm
Weight	125 kg

- Complete stainless steel inner and outer body.
- Environment friendly insulation polyurethane injection at the density of 40-42 kg/m³
- GN 2/1 tray can be fitted.
- The refrigeration is ventileted, plastic coated adjustable wire shelves.
- HACCP Digital thermometer and wheels.





KÄNGABOX TOWER EURO

The **space saving** thermo box for catering

Stackable and easy to carry

The safe and convenient front-loader for gastronomic containers



Leak proof front cover

Perfectly closed lid preventing liquid and air from escaping



Internal sliding grooves



Stackable



Environmental Friendly EPP

- Tough
- Lightweight
- Recyclable
- **Temperature Resistance** - loss or raise of temperature will be between 1° to 3° C per hour



Comply with HACCP

- Food safe
- Dishwasher safe to 80° C

MODEL	COLOUR	VOLUME	WEIGHT	OUTER DIMENSION			INNER DIMENSION		
				L	W	H	L	W	H
TW5400-SZ	BLACK	66	2.4	600	400	490	550	335	545
TW5400-BU	BLUE	66	2.4	600	400	490	550	335	545
		(l)	(kg)			(mm)			(mm)

Slidinglid™ Ice Caddies

CAMBRO

Low Profile



	ICS100L	ICS125L	ICS175L
PRODUCT CODE	4121401-XX	4121402-XX	4121403-XX
CAMBRO CODE	ICS100L	ICS125L	ICS175L
ICE CAPACITY	46 kg (100 Lbs)	57 kg (125 Lbs)	80 kg (175 Lbs)
DESCRIPTION	Low Profile	Low Profile	Low Profile
OVERALL DIA (w x d x h cm)	57 x 77 x 73	58.5 x 80 x 74.5	61 x 95.5 x 74.5
CASTORS TYPE	2 swivel, 2 with brake	2 fixed, 2 swivel, 1 with brake	2 fixed, 2 swivel, 1 with brake

Tall Profile



	ICS125T	ICS175T	ICS200TB
PRODUCT CODE	4121404-XX	4121405-XX	4121406-XX
CAMBRO CODE	ICS125T	ICS175T	ICS200TB
ICE CAPACITY	57 kg (125 Lbs)	80 kg (175 Lbs)	91 kg (200 Lbs)
DESCRIPTION	Tall Profile	Tall Profile	Tall Profile
OVERALL DIA (w x d x h cm)	58.5 x 80 x 88	58.5 x 86.5 x 95.5	58.5 x 86.5 x 100.5
CASTORS TYPE	2 fixed, 2 swivel, 1 with brake	2 fixed, 2 swivel, 1 with brake	2 swivel, 1 with brake, 2 25.4cm Wide Easy Wheels

*Available Colour

■ BK (black) ■ DBR (dark brown) ■ GNGY (granite grey)

When ordering Black Colour add **CODE** suffix to item number (example: 4121404-BK)

Traex® Safety Mate® Ice Porter™

TRAEX®

- Durable, break resistant plastic for long lasting use
- Pour spout
- Built-in easy-grip handle
- Built-in hook for hanging/draining
- Easily transports four units in a Glass rack dolly
- Ice Porter lid sold separately



	7001	7005	7004
PRODUCT CODE	4121805	4121806	4121807
ICE CAPACITY	21.8 Ltr (5.75 Gal)	15.1 (4 Gal)	80 kg (175 Lbs)
DESCRIPTION	With Hanging Bracket	-	Fits 7001 & 7005 Ice Tote
OVERALL DIA (Ø x h cm)	32.2 x 68.1	32.3 x 53	37.9 x 33.1 x 7.6
MATERIAL	HDPE	Polycarbonate	HDPE

SERVISTAR GASTRO 80 and 120 碟车 **BLANCO**

- Plate stacking system, mobile.
- Frame made of high-quality, corrosion-resistant stainless steel.
- Uniquely formed, patented plate holders with soft-grip surface.
- Maximum load-bearing capacity per pair of plate holders: 1 kg.
- Plate spacing: 80 mm.
- Continuously adjustable for plate sizes up to 30 cm.
- Castor model either synthetic or galvanised steel, 125 mm dia., 4 steering castors, 2 of which have brakes.

Unique, patented plate holders

- Thanks to their unique form, the plates are held securely - based on the example of the human hand!
- The plates rest on the plate holders in a soft and non-slip position due to the fine elastic soft-grip surface.
- With its patented plate holders, the *SERVISTAR* has a gentle and secure grip on your porcelain – even when fully loaded and on uneven floors.

- Easy to load
- Easy to remove
- Secure grip



CODE	SIZE (l x w x h cm)	REMARK
4130108	65.3 x 66.3 x 185.6	Holds 80 Plates
4130112	65.3 x 93.3 x 185.6	Holds 120 Plates

PVC Clear Canvas Cover

CODE	REMARK
4130100	Fit 80 Plates Trolley
4130101	Fit 120 Plates Trolley

JACKSTACK®

Lack of space has always been one of the major problems in any professional kitchen. The patented JACKSTACK® plate racks make it possible to stack plates, of any size, from 12 up to 104 plates.

One or two persons can easily move the vertical 104 plate tower in a minimum of time to storage or banquet area. Its 15 cm (6") diameter swivel wheels care for stability.

Clearing up with JACKSTACK® takes no time, 400 plates are taken to the dishwash department in one go.

The counter and wall models are particularly convenient in the small kitchens. The swivel top ensures that plates are always facing you.

CODE	SIZE (l x w x h cm)	REMARK
4130201	60 x 60 x 179	Holds 104 Plates
4130202	60 x 60 x 103	Holds 52 Plates



Plastic Cover 碗碟车塑料套

JACKSTACK®

CODE	SIZE (l x w x h cm)	REMARK
4130200	65.3 x 66.3 x 185.6	For Jackstack® 104 Plates

- Protects prepared food longer and keeps food longer fresh in cold storage.



Thermo - Cover 碗碟车热套

JACKSTACK®

CODE	SIZE (l x w x h cm)	REMARK
4130300	65.3 x 93.3 x 185.6	For Jackstack® 104 Plates

- Preserves in transit. 72-104 plates with warm or cold food in a transportable cabin.
- Keeps food longer fresh.



Camwear® Polycarbonate CamSquare® Food Storage Containers

Maximize your storage area with CamSquare food storage containers. The square shape provides 33% better space usage than traditional round containers. Clear polycarbonate provides product visibility for at a glance inventory management. Seal covers feature an inner and outer seal for superior spill resistance, even during transport.

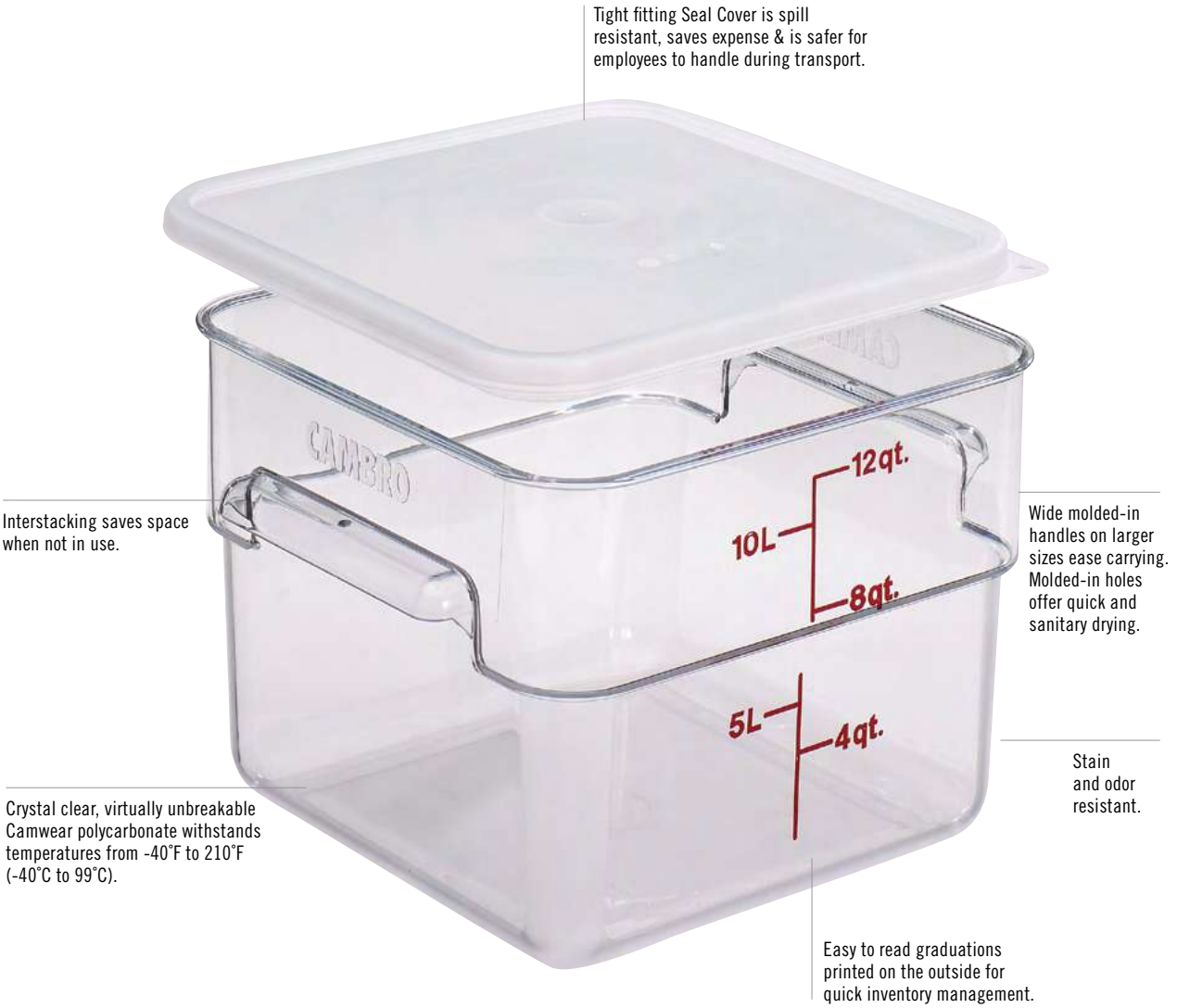

Crystal clear, virtually unbreakable Camwear polycarbonate withstands temperatures from -40°F to 210°F (-40°C to 99°C).

Seal Covers for Camwear CamSquares*

- Inner and outer seal provide excellent spill resistance.
- Includes a hole on the corner for hanging during storage.
- Translucent lid easily identifies contents.
- Withstands temperatures from -40°F to 160°F (-40°C to 70°C).

* Seal covers only fit Camwear Square Containers.

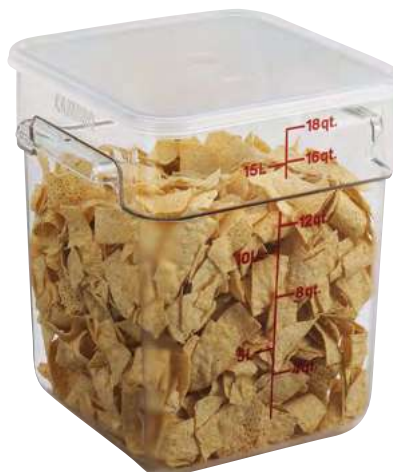

Polycarbonate & Polypropylene CamSquare® Food Storage Containers

Polycarbonate



PRODUCT CODE	9010102	9010104	9010106	9010108	9010112	9010118	9010122
CAMBRO CODE	2SFSCW	4SFSCW	6SFSCW	8SFSCW	12SFSCW**	18SFSCW**	22SFSCW**
CAPACITY	1,9 L	3,8 L	5,7 L	7,6 L	11,4 L	17,2 L	20,8 L
DIMENSION (CM)	18,5 x 18,5 x 10	18,5 x 18,5 x 18,7	21,5 x 21,5 x 18,5	21,5 x 21,5 x 23	25,6 x 31 x 21	25,6 x 31 x 32	25,6 x 31 x 40
CASE PACK	6	6	6	6	6	6	6

Colour: Clear. Height includes covers. **Dimensions include handles.

Note: All graduations are approximate.

Seal Covers for Polycarbonate CamSquare Only

PRODUCT CODE	9016802	9016806	9016812
CAMBRO CODE	SFC2SCPP	SFC6SCPP	SFC12SCPP
DESCRIPTION	Fits 1,9 & 3,8 L	Fits 5,7 & 7,6 L	Fits 11,4, 17,2 & 20,8 L
CASE PACK	6	6	6



Colour: Translucent.

Translucent Polypropylene



PRODUCT CODE	9010202	9010204	9010206	9010208	9010212	9010218	9010222
CAMBRO CODE	2SFSP	4SFSP	6SFSP	8SFSP	12SFSP**	18SFSP**	22SFSP**
CAPACITY	1,9 L	3,8 L	5,7 L	7,6 L	11,4 L	17,2 L	20,8 L
DIMENSION (CM)	18,5 x 18,5 x 10	18,5 x 18,5 x 18,7	21,5 x 21,5 x 18,5	21,5 x 21,5 x 23	25,6 x 31 x 21	25,6 x 31 x 32	25,6 x 31 x 40
CASE PACK	6	6	6	6	6	6	6

Colour: Translucent. Height includes covers. **Dimensions include handles.

Note: All graduations are approximate.

Covers for Polycarbonate & Polypropylene CamSquare Container

PRODUCT CODE	9010302	9010306	9010312
CAMBRO CODE	SFC2	SFC6	SFC12
DESCRIPTION	Fits 1,9 & 3,8 L	Fits 5,7 & 7,6 L	Fits 11,4, 17,2 & 20,8 L
COLOUR	Kelly Green	Winter Rose	Midnight Blue
CASE PACK	6	6	6



Camwear® Polycarbonate Round Food Storage Containers

Store ingredients or transport ready to serve or partially prepared foods. Clear Camwear polycarbonate allows for easy content identification at a glance. Reduces risk of contamination and enhances food safety. Round shape promotes proper air circulation, ideal for stirring soups and sauces.



Seal Cover provides excellent spill resistance.

Crystal clear, virtually unbreakable Camwear polycarbonate withstands temperatures from -40°F to 210°F (-40°C to 99°C).

Molded-in handles ease carrying. Molded-in holes offer quick and sanitary drying.



Interstacking saves space when not in use.

Resists food acids, oils & alcohol. Stain and odor resistant.

Easy to read graduations on the outside for at a glance inventory management.

Round Polycarbonate Covers

- Snap on covers fit tightly.
- Stain resistant to food acids and oils.
- Withstands temperatures from -40°C to 99°C.

PRODUCT CODE	9010501	9010502	9010506	9010512
CAMBRO CODE	RFSCWC1	RFSCWC2	RFSCWC6	RFSCWC12
DESCRIPTION	Fits 0,9 L	Fits 1,9 & 3,8 L	Fits 5,7 & 7,6 L	Fits 11,4, 17,2 & 20,8 L
CASE PACK	12	12	12	6

Colour: Clear.



Seal Covers for Polycarbonate Round Container

- Inner and outer seal provide excellent spill resistance.
- Safe from -40°C to 70°C.
- Thumb tab for easy removal.

PRODUCT CODE	9010601	9010602	9010606	9010612
CAMBRO CODE	RFS1SCPP	RFS2SCPP	RFS6SCPP	RFS12SCPP
DESCRIPTION	Fits 0,9 L	Fits 1,9 & 3,8 L	Fits 5,7 & 7,6 L	Fits 11,4, 17,2 & 20,8 L
CASE PACK	12	12	12	6

Colour: Translucent.



Polycarbonate & Polypropylene Round Food Storage Containers

Polycarbonate



PRODUCT CODE	9010401	9010402	9010404	9010406	9010408	9010412	9010418	9010422
CAMBRO CODE	RFSCW1	RFSCW2	RFSCW4	RFSCW6	RFSCW8	RFSCW12	RFSCW18	RFSCW22
CAPACITY	0,9 L	1,9 L	3,8 L	5,7 L	7,6 L	11,4 L	17,2 L	20,8 L
TOP DIAMETER	15,4 cm	20,8 cm	20,8 cm	25,2 cm	25,2 cm	37,8 cm	37,8 cm	37,8 cm
HEIGHT	12,7 cm	11,1 cm	21,8 cm	20,2 cm	27,6 cm	21,3 cm	30,5 cm	38,1 cm
CASE PACK	12	12	12	12	12	6	6	6

Colour: Clear. Top diameter dimension includes handle. Height dimension includes cover.

Note: All graduations are approximate.

Translucent Polypropylene



PRODUCT CODE	9010701	9010702	9010704	9010706	9010708	9010712	9010718	9010722
CAMBRO CODE	RFS1PP	RFS2PP	RFS4PP	RFS6PP	RFS8PP	RFS12PP	RFS18PP	RFS22PP
CAPACITY	0,9 L	1,9 L	3,8 L	5,7 L	7,6 L	11,4 L	17,2 L	20,8 L
TOP DIAMETER	15,4 cm	20,8 cm	20,8 cm	25,2 cm	25,2 cm	37,8 cm	37,8 cm	37,8 cm
HEIGHT	12,7 cm	11,1 cm	21,8 cm	20,2 cm	27,6 cm	21,3 cm	30,5 cm	38,1 cm
CASE PACK	12	12	12	12	12	6	6	6

Colour: Translucent. Top diameter dimension includes handle. Height dimension includes cover.

Note: All graduations are approximate.

Covers for Translucent Polypropylene Rounds

PRODUCT CODE	9010801	9010802	9010806	9010812
CAMBRO CODE	RFSC1PP	RFSC2PP	RFSC6PP	RFSC12PP
DESCRIPTION	Fits 0,9 L	Fits 1,9 & 3,8 L	Fits 5,7 & 7,6 L	Fits 11,4, 17,2 & 20,8 L
CASE PACK	12	12	12	6



Colour: Translucent.

Camwear® Food Storage Boxes – Eliminate the hazard of cross contamination.

Extend the freshness of ingredients and eliminate points of cross contamination by transferring product into food boxes at the receiving dock. A safe solution for storing bulk fruits and vegetables. Clear polycarbonate allows visibility for product identification. Snap tight Camwear covers or SlidingLids™, sold separately, won't come off during transportation.



Camwear Flat Lids

- Snap-tight covers won't come off during transport.
- Top molded-in rails for safer, more secure stacking.
- Durable Camwear polycarbonate is safe from -40°F to 210°F (-40°C to 99°C).

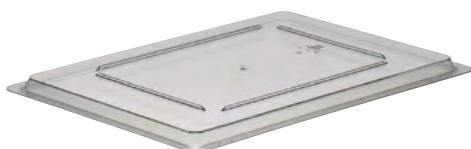

Camwear SlidingLids fits Camwear Food Storage Boxes

- Lid slides back to easily access contents, minimizing handling.
- Reduces the risk of cross contamination since lid remains on food box.
- Made of virtually unbreakable Camwear polycarbonate.



Polycarbonate Food Storage Boxes

Size 46 x 66 cm (18" x 26")



	9011009	9011015	9011023	9011030	9011038	Coloured Container	
PRODUCT CODE	9011009	9011015	9011023	9011030	9011038	9011015-RD	9011015-YE
CAMBRO CODE	18263CW	18266CW	18269CW	182612CW	182615CW	18266CW467	18266CW464
CAPACITY	18,9 L	33,1 L	49,2 L	64,4 L	83,3 L	33,1 L	33,1 L
DIMENSION (CM)	46 x 66 x 9	46 x 66 x 15	46 x 66 x 23	46 x 66 x 30	46 x 66 x 38	46 x 66 x 15	46 x 66 x 15
COLOUR	Clear	Clear	Clear	Clear	Clear	Safety Red	Safety Yellow
CASE PACK	6	6	4	4	3	6	6

Size 30.5 x 46 cm (12" x 18")



	9010909	9010915	9010923	Coloured Container		
PRODUCT CODE	9010909	9010915	9010923	9010915-RD	90110915-YE	90110923-YE
CAMBRO CODE	12183CW	12186CW	12189CW	12186CW467	12186CW464	12189CW464
CAPACITY	6,6 L	11,4 L	18 L	11,4 L	11,4 L	18 L
DIMENSION (CM)	30,5 x 46 x 9	30,5 x 46 x 15	30,5 x 46 x 23	30,5 x 46 x 15	30,5 x 46 x 15	30,5 x 46 x 23
COLOUR	Clear	Clear	Clear	Safety Red	Safety Yellow	Safety Yellow
CASE PACK	6	6	6	6	6	6

Polycarbonate Food Storage Covers

Size 46 x 66 cm (18" x 26")



	Flat Lid	Sliding Lid	Coloured Lid	
PRODUCT CODE	9011102	9011202	9011102-RD	9011102-YE
CAMBRO CODE	1826CCW	1826SCCW	1826CCW467	1826CCW464
DIMENSION (CM)	45,7 x 66	45,7 x 66	45,7 x 66	45,7 x 66
COLOUR	Clear	Clear	Safety Red	Safety Yellow
CASE PACK	6	6	6	6

Polycarbonate Food Storage Covers

Size 30,5 x 45,7 cm (12" x 18")



	Flat Lid	Sliding Lid	Coloured Lid	
PRODUCT CODE	9011101	9011201	9011101-RD	9011101-YE
CAMBRO CODE	1218CCW	1218SCCW	1218CCW467	1218CCW464
DIMENSION (CM)	30,5 x 45,7	30,5 x 45,7	30,5 x 45,7	30,5 x 45,7
COLOUR	Clear	Clear	Safety Red	Safety Yellow
CASE PACK	6	6	6	6

Polyethylene Food Storage Boxes

Size 46 x 66 cm (18" x 26")



	9011409	9011415	9011423	9011430	9011438	Flat Lid 9011502
PRODUCT CODE	9011409	9011415	9011423	9011430	9011438	9011502
CAMBRO CODE	18263P	18266P	18269P	182612P	182615P	1826CP
CAPACITY	18,9 L	33,1 L	49,2 L	64,4 L	83,3 L	-
DIMENSION (CM)	46 x 66 x 9	46 x 66 x 15	46 x 66 x 23	46 x 66 x 30	46 x 66 x 38	45,7 x 66
COLOUR	White	White	White	White	White	White
CASE PACK	6	6	6	4	3	6

Size 30.5 x 46 cm (12" x 18")



	9011309	9011315	9011323	Flat Lid 9011501
PRODUCT CODE	9011309	9011315	9011323	9011501
CAMBRO CODE	12183CW	12186CW	12189CW	1218CP
CAPACITY	6,6 L	11,4 L	18 L	-
DIMENSION (CM)	30,5 x 46 x 9	30,5 x 46 x 15	30,5 x 46 x 23	30,5 x 45,7
COLOUR	White	White	White	White
CASE PACK	6	6	6	6

Drain Shelf & Colanders Polycarbonate



	For 46 x 66cm 9011602	For 30,5 x 46cm 9011601	Colanders 9011701	9011702
PRODUCT CODE	9011602	9011601	9011701	9011702
CAMBRO CODE	1826DSCW	1218DSCW	1826CLRCW (12,7cm Deep)	18268CLRCW (20 cm Deep)
DIMENSION	Fits 46 x 66 cm Food Storage Boxes	Fits 30,5 x 46 cm Food Storage Boxes	Fits Polycarbonate Food Storage Boxes 46 x 66 x 15 cm & deeper	Fits Polycarbonate Food Storage Boxes 46 x 66 x 23 cm & deeper
COLOUR	Clear	Clear	Clear	Clear
CASE PACK	6	6	6	4



Food Rotation Label, Biodegradable 散装分配器包装

CODE	SIZE (l x w cm)	SPEC
9011801	5 x 7.6	24 rolls, 250 Labels per roll

Ingredient Bins & Camcrisper®

Ingredient Bins

- Store bulk dry ingredients such as flour and grain.
- Hygienic clear sliding lid reduces handling and allows for quick content identification.
- Bin made of FDA-accepted material so no liners are needed.
- Designed to fit under standard work tables.

Camcrisper

- A self-contained system for brining or storing, washing and transporting bulk produce.
- Prevents cross contamination and minimizes unnecessary handling.
- Transfer dry produce out of cartons into bin, cover and roll into cooler for safe storage.
- Wash and rinse produce for easy and safe prep.



Casters feature wide wheels for excellent stability and weight bearing capability.



PRODUCT CODE	9011921	9011927	9011937	9016927
CAMBRO CODE	IBS20	IBS27	IBS37	IBSF27
CAPACITY	81 L	102 L	140 L	102 L
CUBIC FEET	0.081	0.102	0.140	0.101
DIMENSION (CM)	33 x 75 x 71	42 x 75 x 71	55 x 75 x 71	33 x 76.5 x 72.5
LOAD CAPACITY (SUGAR)	77 Kg	103 Kg	143 Kg	98 Kg
LOAD CAPACITY (FLOUR)	63 Kg	68 Kg	102 Kg	68 Kg
REMARK	2 Fixed, 2 Swivel	2 Fixed, 2 Swivel	2 Fixed, 2 Swivel	2 Fixed, 2 Swivel



PRODUCT CODE	9017032	9012036	9012044	9012132
CAMBRO CODE	IB32	IB36	IB44	CC32
CAPACITY	121 L	129 L	161 L	121 L
CUBIC FEET	0.123	0.134	0.160	0.123
DIMENSION (CM)	56 x 61 x 58.5	39 x 75 x 74	47 x 75 x 74	56 x 61 x 58.5
LOAD CAPACITY (SUGAR)	98 Kg	114 Kg	145 Kg	24 lettuce heads (unfinished)
LOAD CAPACITY (FLOUR)	73 Kg	82 Kg	104 Kg	42 lettuce heads (finished)
REMARK	2 Fixed, 2 Swivel	2 Fixed, 2 Swivel	2 Fixed, 2 Swivel	2 Fixed, 2 Swivel

STORAGE & TRANSPORT



Flour Ingredient Bin 面粉箱



CODE	SIZE (l x w x h x cm)	SPEC	CAP (kg)
9012201	59.7 x 29.2 x 42.9	100 Cups	11.3
9012202	48.8 x 59.7 x 42.62	200 Cups	22.7



Polycarbonate Ice Scoop 胶冰铲



CODE	CAP (oz)	REMARKS
2170106	6	SCP6CW
2170112	12	SCP12CW
2170124	24	SCP24CW
2170164	64	SCP64CW

Pizza Dough Box 比萨饼面团存储箱



Polycarbonate 比萨饼面团存储箱



CODE	SIZE (l x w x h Inch)	REMARKS
6110703	26 x 18 x 3	DB18263CW
6110706	26 x 18 x 6	DB18266CW



Polypropylene 比萨饼面团存储箱



CODE	SIZE (l x w x h Inch)	REMARKS
6113903	26 x 18 x 3	DB18263P

Cover For Dough Box 盖子

CODE	SIZE (l x w Inch)	REMARKS
6110800	26 x 18	DBC1826CW

Colour: White

Cover For Dough Box 盖子

CODE	SIZE (l x w Inch)	REMARKS
6114000	26 x 18	DBC1826P

Colour: White

Pizza Dough Camdolly 比萨饼面团存储箱小车



CODE	SIZE (l x w x h Inch)	REMARKS
6110900	19.78" x 27.78" x 10.14"	CD1826PDB-401

Colour: Slate Blue



Hold 136kg

Plastic Container With Cover 胶食物盒



CODE	SIZE (l x w x h cm)	REMARKS
9012501	19.0 x 19.0 x 7.7	A-612
9012502	21.5 x 21.5 x 8.8	A-613
9012503	24.0 x 24.0 x 10	A-614
9012504	28.0 x 28.0 x 11	A-615



CODE	SIZE (l x w x h cm)	CAP	REMARKS
9012601	15.2 x 11.0 x 9.3	940 ml	A-617
9012602	17.5 x 12.7 x 11.6	1.75 L	A-618
9012603	19.6 x 14.2 x 14.0	2.75 L	A-619
9012604	27.8 x 16.5 x 13.8	4.0 L	A-620

With Marking

9012603A 19.6 x 14.2 x 14.0 2.75 L A-619/A



CODE	SIZE (l x w x h cm)	CAP	REMARKS
9013501	37 x 27.5 x 13.2	10.3 L	A-700



CODE	SIZE (l x w x h cm)	CAP	REMARKS
5180431	12.5 x 8.8 x 4.0	280 ml	1286-831
5180432	15.2 x 10.8 x 5.0	530 ml	1286-832
5180433	17.9 x 12.8 x 5.8	910 ml	1286-833
5180434	20.6 x 14.8 x 6.8	1.4 L	1286-834
5180435	22.7 x 15.6 x 9.1	2.2 L	1286-835
5180436	25.6 x 17.9 x 9.8	3 L	1286-836
5180437	30.3 x 20.7 x 10.7	5 L	1286-837
5180438	34.3 x 23.5 x 11.6	7 L	1286-838
5180439	39.6 x 26.7 x 12.6	10 L	1286-839



CODE	SIZE (l x w x h cm)	CAP (ml)	REMARKS
9013601	11.5 x 11.5 x 9.8	750	A-205



CODE	SIZE (l x w x h cm)	CAP	REMARKS
9013401	11.7 x 7.9 x 4.6	260 ml	A-699
9012801	15.3 x 11.0 x 5.8	550 ml	A-627
9012802	17.8 x 13.0 x 7	950 ml	A-628
9012803	20.2 x 14.5 x 9	1.83 L	A-629
9012804	31.0 x 22.5 x 11	4.90 L	A-630
9012805	27.8 x 20.0 x 10	3.65 L	A-631
9012806	34.5 x 24.5 x 12	7.45 L	A-635



Tight-Seal Lid 密封盖

CODE	SIZE (l x w x h cm)	CAP	REMARKS
9013701-xx	14.9 x 9.9 x 9.3	750 ml	A-5912

*Available Colour

GR OR

When ordering Container add **CODE** suffix to item number
(example: 9013701-GR)



CODE	SIZE (l x w x h cm)	CAP	REMARKS
5180540	15.2 x 10.5 x 9.3	1.0 L	1286-840
5180541	17.8 x 12.5 x 10.7	1.7 L	1286-841
5180542	20.6 x 14.8 x 13.0	2.8 L	1286-842
5180543	26.0 x 17.9 x 15.3	5.2 L	1286-843
5180544	30.1 x 20.7 x 16.5	7.9 L	1286-844
5180545	34.3 x 23.9 x 17.7	11 L	1286-845
5180546	39.6 x 26.7 x 19.0	15.8 L	1286-846

STORAGE & TRANSPORT

Plastic Container With Cover 胶食物盒



CODE	SIZE (l x w x h cm)	CAP	REMARKS
9014301	39.8 x 29.8 x 11.6	9.4 L	A-2001A
9014302	32.5 x 23.0 x 11.0	5.2 L	A-2002A
9014303	27.5 x 16.2 x 13.0	3.8 L	A-2003A
9014304	17.5 x 13.0 x 11.5	1.6 L	A-2004A



CODE	SIZE (l x w x h cm)	CAP	REMARKS
9014401	32.8 x 17.9 x 7.7	2.9 L	A-2011
9014402	32.8 x 32.8 x 7.8	5.9 L	A-2012

Plastic Container Cover Only 胶蒸盆盖



CODE	SIZE (l x w x h cm)	REMARKS
9014501	34.8 x 18.4 x 8	A-2011C
9014502	35.0 x 33.3 x 8	A-2012C

CODE	SIZE (l x w x h cm)	REMARKS
5180710	27 x 20.0 x 16.5	5460-363/T
5180712	32 x 25.0 x 19.5	5460-364/T
5180714	37 x 30.0 x 22.5	5460-365/T
5180716	42 x 34.5 x 25.5	5460-366/T



Condiment Container 调味品盒



CODE	SIZE (l x w x h cm)	CAP	REMARKS
9013101-xx	16.5 x 6.5 x 11.5	645 ml	A-679
9013001-xx	16.5 x 9.5 x 11.5	1.0 L	A-678

CODE	SIZE (Ø x h cm)	CAP	REMARKS
9012901	16.0 x 9.0	1.2 L	A-637
9012902	19.0 x 10.7	2.0 L	A-638
9012903	21.5 x 12.3	3.0 L	A-639

*Available Colour

GR RD YE

When ordering Container add **CODE** suffix to item number
(example: 9013101-GR)



CODE	SIZE (Ø x h cm)	CAP	REMARKS
9013215	13.7 x 16.6	1.5 L	A-693
9013227	16.5 x 19.2	2.75 L	A-694
9013244	18.7 x 22.5	4.4 L	A-695

CODE	SIZE (Ø x h cm)	CAP	REMARKS
9013301	10.5 x 9.8	650 ml	A-697
9013302	11.8 x 11.8	1.0 L	A-698

Storage Container with Cover 胶盒



Small

CODE	SIZE (l x w x h cm)
9014101-xx	44 x 30.2 x 20

REMARK:
A-1831/1832

*Available Colour

GR BL



Medium

CODE	SIZE (l x w x h cm)
9014201-xx	49.2 x 35 x 27.2

REMARK:
A-1837/1838

*Available Colour

GR BL



Large

CODE	SIZE (l x w x h cm)
9014001-xx	56 x 39.5 x 30

REMARK:
A-1829/1830

*Available Colour

RD BL

When ordering Red add **CODE** suffix to item number (example: 9014001-RD)

Stackable Container 胶盒

CODE	SIZE (l x w x h cm)	REMARKS
9013901	56.5 x 38 x 7.6	A-1817



CODE	SIZE (l x w x h cm)	REMARKS
5181210-xx	42 x 32 x 9	SG-8810

CODE	SIZE (l x w x h cm)	REMARKS
5181211-xx	64 x 42 x 9	SG-8811
5181212-xx	64 x 42 x 16	SG-8812

Cover Only

9014701	65.5 x 42.5 x 2.0	SG-8811/2A
---------	-------------------	------------

*Available Colour

BL GY

When ordering Grey add **CODE** suffix to item number (example: 5181210-GY)

STORAGE & TRANSPORT

Stackable Container 工业箱



Side Hole

CODE	SIZE (l x w x h cm)
9014801	63 x 37 x 13.5

REMARK:
SG-8813-BE



Shallow

CODE	SIZE (l x w x h cm)	REMARKS
9014901-xx	53 x 40 x 6.7	
9014902-xx	53 x 40 x 8.6	
9014903-xx	53 x 40 x 10	

Cover
9015001 SG-8815C

REMARK:
SG-8815B
SG-8817B
SG-8819B

*Available Colour

■ YE ■ GY

When ordering Grey add **CODE** suffix to item number (example: 9014901-GY)



CODE	SIZE (l x w x h cm)
9015101-xx	34.5 x 27 x 12.7

REMARK:
SG-8820

*Available Colour

■ BL ■ GY

When ordering Grey add **CODE** suffix to item number (example: 9015101-GY)



CODE	SIZE (l x w x h cm)
9015201-xx	55 x 42.5 x 24

Cover
9015301 SG-8821A-NL

REMARK:
SG-8821B

*Available Colour

■ BL ■ GY

When ordering Grey add **CODE** suffix to item number (example: 9015301-GY)



CODE	SIZE (l x w x h cm)
9015401-xx	43 x 26.5 x 13

REMARK:
SG-8822

*Available Colour

■ BL ■ GY

When ordering Grey add **CODE** suffix to item number (example: 9015401-GY)



CODE	SIZE (l x w x h cm)
9015501-xx	46 x 36 x 15

Cover
9015601 46 x 36 x 3 SG-8823A-NL

REMARK:
SG-8823B

*Available Colour

■ BL ■ GY

When ordering Grey add **CODE** suffix to item number (example: 9015401-GY)

Stackable Container 工业箱



Perforated Side

CODE	SIZE (l x w x h cm)
9015701-RD	59.5 x 39.0 x 19.0
9015801-RD	59.3 x 38.9 x 24.7

REMARK:
SG-8825
SG-8826



CODE	SIZE (l x w x h cm)	REMARKS
9015901-xx	60 x 45 x 22.0	
9015902-xx	60 x 45 x 32.5	

Cover
9016001 61 x 46 x 3 SG-8828/9A

REMARK:
SG-8828
SG-8829

*Available Colour

■ BL ■ GY ■ YE



CODE	SIZE (l x w x h cm)
9016101-xx	66 x 45 x 23
9016201-xx	66 x 45 x 38

Cover
9016301 67 x 46 x 2 SG-8832/4A

REMARK:
SG-8832
SG-8834

*Available Colour

■ BL ■ GY ■ YE ■ RD

When ordering Grey add **CODE** suffix to item number (example: 9016101-GY)



With Metal Handle

CODE	SIZE (l x w x h cm)
9016401-xx	70 x 49 x 43

REMARK:
SG-8833

*Available Colour

■ BL ■ RD ■ GR

When ordering Red add **CODE** suffix to item number (example: 9016401-RD)



With Cover

CODE	SIZE (l x w x h cm)
9014601	48 x 33.5 x 26.9

REMARK:
SG-8891

Space Saver Box



CODE	SIZE (l x w x h cm)
------	------------------------

9016601-GY 50 x 31 x 20.6
9016701-GY 50 x 31 x 28.5

Cover
9016501 51 x 32 x 3 SG-8899A

REMARK:
SG-8889B
SG-8899B

Camshelving®

ELEMENTS Series

Camshelving® Elements Series

STRONG TECHNOLOGY



- Composite material is as strong as steel.
- 1980 mm traverse is the longest and strongest in the industry; supports loads up to 272 Kg per shelf.
- 60% lighter in weight than steel; easy to set up, adjust and change configurations.
- Resistant to moisture; won't rust or corrode.

HYGIENIC DESIGN



- Non-porous surface simply wipes clean.
- Shelf plates are easily removed for thorough dishwasher cleaning.
- Camguard® Antimicrobial protection is permanently embedded in shelf plates.
- Camguard works continuously to suppress the growth of microbes between cleanings.

SHELVING FOR LIFE



- Lifetime warranty against corrosion and rust.
- Withstands temperatures as cold as -38°C or warm environments up to 88°C.
- Ideal for wet, dry, cold or humid environments.
- Impervious to moisture and chemicals.
- Won't peel, dent or warp; corrosion resistant.

4 Shelf Unit Weight Bearing Chart

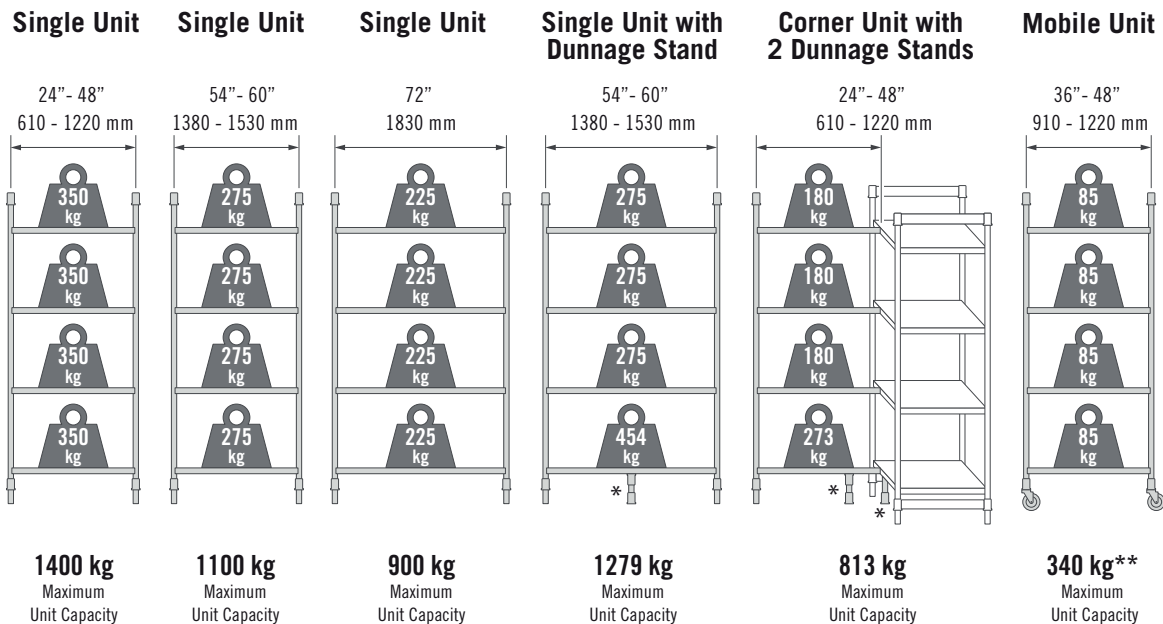

* Dunnage Stands add stability and increase weight bearing capacity on bottom shelf only. Add to any shelf length. Highly recommended for Starter Units 1380 mm (54") and longer, all Corner Units, U-Shape Units and units specified for heavier loads.

** Due to the weight bearing capacity of casters, maximum weight load on an entire Mobile Unit is 340 kg.

ELEMENTS SERIES

V4

4-Shelf Vented Stationary Units

72"
HEIGHT

Starter units include 2 factory assembled stationary post kits, stationary traverses, stationary traverse dovetails and shelf plates. Add-On units include 1 factory assembled stationary post kit, stationary traverses, stationary traverse dovetails and shelf plates. Units ship complete in 1 box.

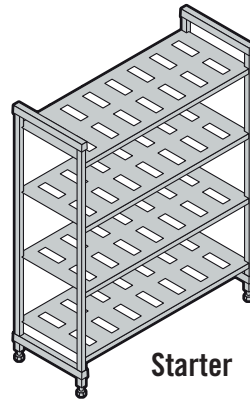

Starter

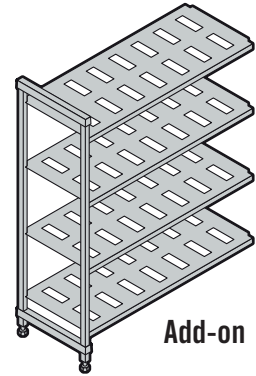

Add-on

18" DEPTH	DIMENSIONS (D x L x H)
	18" x 24" x 72"
	18" x 30" x 72"
	18" x 36" x 72"
	18" x 42" x 72"
	18" x 48" x 72"
	18" x 54" x 72"
	18" x 60" x 72"
	18" x 72" x 72"

STARTER CODE
ESU182472V4
ESU183072V4
ESU183672V4
ESU184272V4
ESU184872V4
ESU185472V4
ESU186072V4
ESU187272V4

ADD-ON CODE
EA182472V4
EA183072V4
EA183672V4
EA184272V4
EA184872V4
EA185472V4
EA186072V4
EA187272V4

21" DEPTH	DIMENSIONS (D x L x H)
	21" x 24" x 72"
	21" x 30" x 72"
	21" x 36" x 72"
	21" x 42" x 72"
	21" x 48" x 72"
	21" x 54" x 72"
	21" x 60" x 72"
	21" x 72" x 72"

STARTER CODE
ESU212472V4
ESU213072V4
ESU213672V4
ESU214272V4
ESU214872V4
ESU215472V4
ESU216072V4
ESU217272V4

ADD-ON CODE
EA212472V4
EA213072V4
EA213672V4
EA214272V4
EA214872V4
EA215472V4
EA216072V4
EA217272V4

24" DEPTH	DIMENSIONS (D x L x H)
	24" x 24" x 72"
	24" x 30" x 72"
	24" x 36" x 72"
	24" x 42" x 72"
	24" x 48" x 72"
	24" x 54" x 72"
	24" x 60" x 72"
	24" x 72" x 72"

STARTER CODE
ESU242472V4
ESU243072V4
ESU243672V4
ESU244272V4
ESU244872V4
ESU245472V4
ESU246072V4
ESU247272V4

ADD-ON CODE
EA242472V4
EA243072V4
EA243672V4
EA244272V4
EA244872V4
EA245472V4
EA246072V4
EA247272V4

Need More information? Please contact us for a complete ranges of Cambro Shelving Systems

78" HEIGHT

Mobile units include 2 factory assembled mobile post kits, mobile traverses, mobile traverse dovetails, shelf plates, and 4 premium swivel casters with total locking brake. Units ship complete in 1 box.

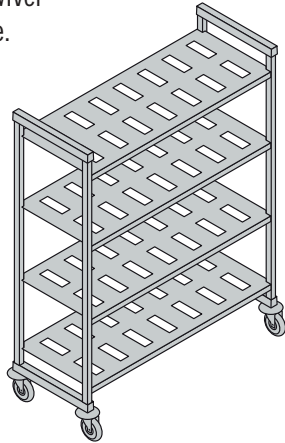

V4 4-Shelf Vented Mobile Units

18" DEPTH	DIMENSIONS (D x L x H)	STARTER CODE
	18" x 36" x 78"	EMU183678V4
	18" x 48" x 78"	EMU184878V4
	18" x 60" x 78"	EMU186078V4
21" DEPTH	DIMENSIONS (D x L x H)	STARTER CODE
	21" x 36" x 78"	EMU213678V4
	21" x 48" x 78"	EMU214878V4
	21" x 60" x 78"	EMU216078V4
24" DEPTH	DIMENSIONS (D x L x H)	STARTER CODE
	24" x 36" x 78"	EMU243678V4
	24" x 48" x 78"	EMU244878V4
	24" x 60" x 78"	EMU246078V4

Element Camshelving Accessories & Add-Ons

Vented Single Shelf Kits for Stationary Units

Include Vented Shelf Plates & Traverse.

**Cannot be used for mobile units*



18" DEPTH	DIMENSIONS (D x L)	SHELF KITS CODE	21" DEPTH	DIMENSIONS (D x L)	SHELF KITS CODE	24" DEPTH	DIMENSIONS (D x L)	SHELF KITS CODE
	18" x 24"	ESK1824V		21" x 24"	ESK2124V		24" x 24"	ESK2424V
	18" x 30"	ESK1830V		21" x 30"	ESK2130V		24" x 30"	ESK2430V
	18" x 36"	ESK1836V		21" x 36"	ESK2136V		24" x 36"	ESK2436V
	18" x 42"	ESK1842V		21" x 42"	ESK2142V		24" x 42"	ESK2442V
	18" x 48"	ESK1848V		21" x 48"	ESK2148V		24" x 48"	ESK2448V
	18" x 54"	ESK1854V		21" x 54"	ESK2154V		24" x 54"	ESK2454V
	18" x 60"	ESK1860V		21" x 60"	ESK2160V		24" x 60"	ESK2460V
	18" x 72"	ESK1872V		21" x 72"	ESK2172V		24" x 72"	ESK2472V

Need More information? Please contact us for a complete ranges of Cambro Shelving Systems

Element Camshelving Accessories & Add-Ons

Vented Single Shelf Kits for Mobile Units

Include Vented Shelf Plates & mobile units Traverse.



18"

DEPTH

DIMENSIONS (D x L)	SHELF KITS CODE
18" x 36"	EMSK1836V
18" x 48"	EMSK1848V
18" x 60"	EMSK1860V

21"

DEPTH

DIMENSIONS (D x L)	SHELF KITS CODE
21" x 36"	EMSK2136V
21" x 48"	EMSK2148V
21" x 60"	EMSK2160V

24"

DEPTH

DIMENSIONS (D x L)	SHELF KITS CODE
24" x 36"	EMSK2436V
24" x 48"	EMSK2448V
24" x 60"	EMSK2460V

Corner Connectors

Unique patented design ensures maximum shelf space utilization. Use 1 set per shelf to connect starter and add-on units in corners. Connect 4 or 5 intermediate shelves between 2 starter units (2 sets required per shelf). Available as a single set or 8 or 10 set packs.

CODE	DESCRIPTION
ECC1	1 Set
ECC8	8 Sets
ECC10	10 Sets

Colour: Brushed Graphite

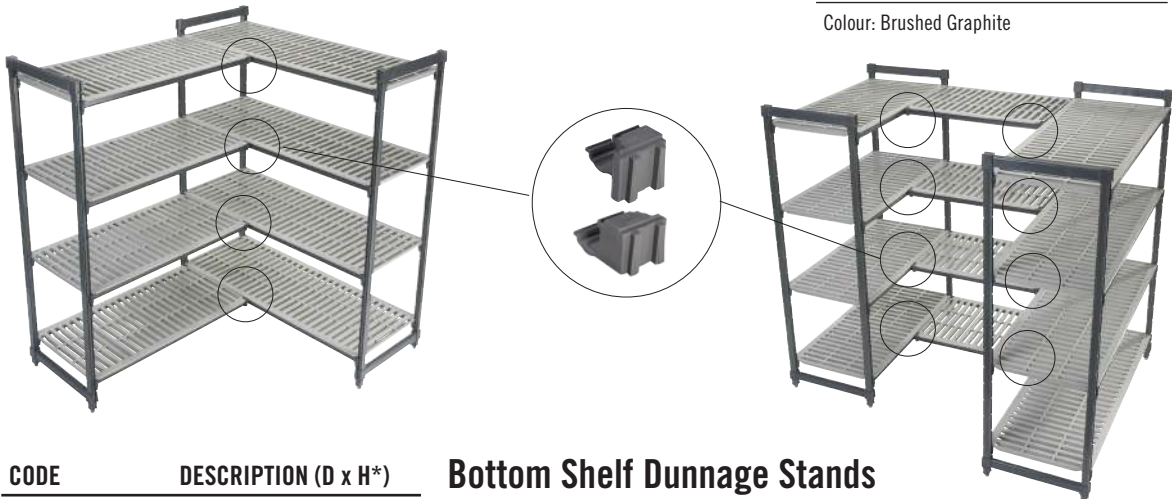

CODE **DESCRIPTION (D x H*)**

Dunnage Stand - Low

EDS18H6	18" x 6.5"
EDS21H6	21" x 6.5"
EDS24H6	24" x 6.5"

Dunnage Stand - Tall

EDS18H10	18" x 10.5"
EDS21H10	21" x 10.5"
EDS24H10	24" x 10.5"

Case Pack: 1 Colour: Brushed Graphite

Bottom Shelf Dunnage Stands

Increase weight bearing capacity on bottom shelf only. Add to any shelf length. Highly recommended for starter units 54" and longer and all corner units, intermediate units and units specified for heavier load volume on and off bottom shelves.

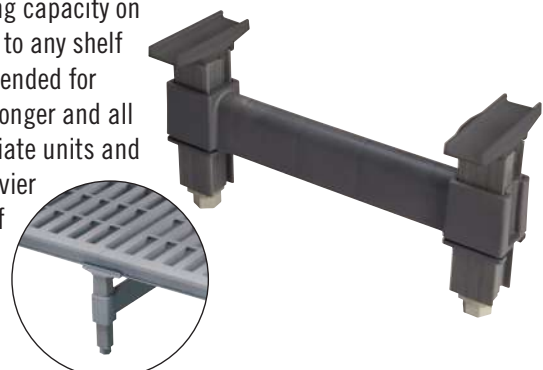

Element Camshelving Accessories & Add-Ons

Donut Bumper for Mobile Units Only

Offers added protection during transport and when maneuvering mobile units into place against walls or alongside other units for storage.

CODE	SIZE
CSMHDDB	5"

Case Pack: 4
Colour: Gray

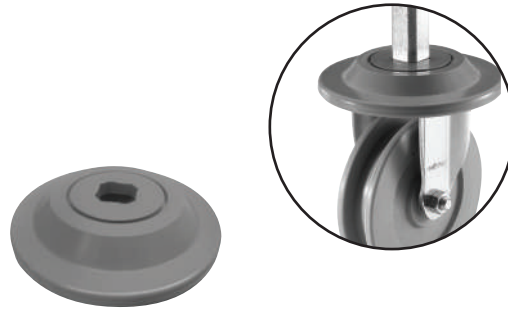

Shelf Divider

Stack and separate items stored on shelves. Made of highly durable ABS plastic. Installs directly onto solid or vented shelves. Easily removable for relocating or washing.

CODE	DIMENSION (D x H)	
CSSD188	18" x 8"	for 18" Depth Shelving
CSSD218	21" x 8"	for 21" Depth Shelving
CSSD248	24" x 8"	for 24" Depth Shelving

Case Pack: 1
Colour: Soft Gray



Shelf Divider Bars (for 24" depth shelf only)

Create a custom service or storage station for food pans, boxes or dish racks. Install straight or angled dividers directly onto shelf traverses.

CODE	DESCRIPTION
EDBA	Angled Divider Bar
EDBS	Straight Divider Bar

Case Pack: 4
Colour: Speckled Gray



Single Shelf Security Cage (for 24" depth shelf only)

Securely store valuable products on a single shelf. Made of heavy duty, 304 stainless steel for use in any environment. Requires 18" height between shelves.

Install on vented shelves only.

Lock not included.

CODE	DIMENSION (D x L x H)
CSSC244818	25.25" x 42.5" x 18"

Case Pack: 1
Colour: Silver



Element Camshelving Accessories & Add-Ons

Vertical Drying and Storage Cradle Only (for 24" depth shelf only)

Modular 7-slot rack designed for drying and storing trays, sheet pans, cutting boards and lids. Installs directly onto shelf traverses. Made of highly durable ABS plastic.

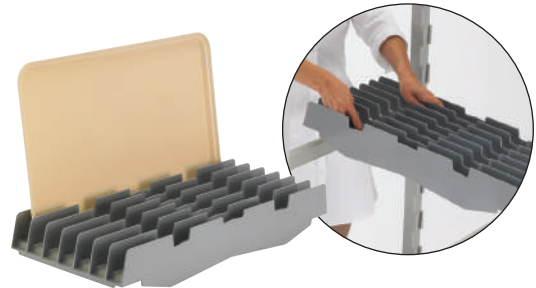

CODE	DIMENSION (D x L x H)
CSDR7	23.5" x 10.25" x 33.75"

Case Pack: 1
Colour: Soft Gray

Vertical Drying and Storage Mobile Rack

Promotes sanitary drying, safe handling and efficient product organization with easy access to product.

Units ship complete with factory assembled mobile post kits, 6 mobile shelf traverses, mobile shelf traverse dovetails, 12 or 15 vertical drying cradles and premium swivel casters with total locking brake. Assembly required.



CODE	DIMENSION (D x L x H)	HOLDING CAPACITY
EMU244878DRPKG	24" x 48" x 78"	84 trays
EMU246078DRPKG	24" x 60" x 78"	105 trays

Colour: Brushed Graphite

Angled Drying and Storage Cradle (for 24" depth shelf only)

Uniquely designed cradle holds up to 8 each meal delivery pellets or use to dry, store and transport food pans and other commercial kitchen ware. Installs directly onto shelf traverses. Made of highly durable ABS plastic.

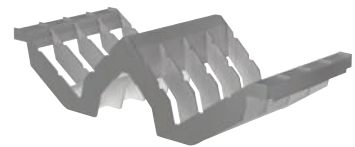

CODE	DIMENSION (D x L x H)	CASE PACK
CSDR8	23.516" x 10.15" x 6.516"	1

Colour: Soft Gray

Angled Drying and Storage Mobile Rack

Promotes sanitary drying, safe handling and efficient product organization with easy access to product.

Unit ships complete with factory assembled mobile post kits, 8 mobile shelf traverses, mobile shelf traverse dovetails, 16 angled drying cradles and premium swivel casters with total locking brake. Assembly required.



CODE	DIMENSION (D x L x H)	HOLDING CAPACITY
EMU244878PDPKG	24" x 48" x 78"	128 Pellets and Bases or 16 GN 1/1 Food Pans

Colour: Brushed Graphite

Camshelving®

BASICS Series



innovative, strong composite material with stands all elements

- designed for all areas of food service operations.
- ideal for wet, dry, cold or hot environments.
- withstands temperatures as cold as -38°C or warm environments up to 88°C.
- resistant to moisture; won't rust or corrode.

smart design

- designed with flexibility to fit into any space.
- shelf plates are easily removed for thorough dishwasher cleaning.
- non-porous surface simply wipes clean.

uncompromised reliability

- composite material has a memory feature and is stronger than common wire or aluminum shelving.
- up to 60% lighter in weight than steel; easy to set up, adjust and change configurations.
- ideal for freezers, walk-in coolers, any wet or humid environment or dry storage room.

exceptional value

- impervious to moisture, salt and chemicals.
- won't peel, dent or warp; remains rust-free.
- lifetime warranty against corrosion and rust.

4 Shelf Unit Weight Bearing Chart

Single Unit

30" - 36"
760 - 910 mm

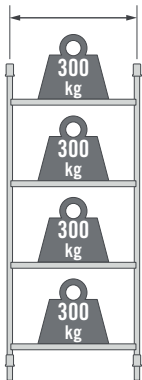

1200 kg
Maximum
Unit Capacity

Single Unit

42" - 48"
1070 - 1220 mm

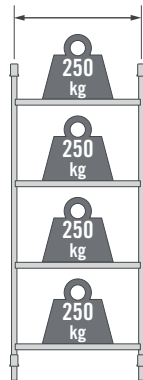

1000 kg
Maximum
Unit Capacity

Single Unit

54" - 60"
1380 - 1530 mm

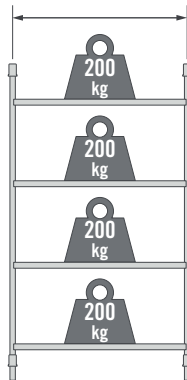

800 kg
Maximum
Unit Capacity

Single Unit with Dunnage Stand

54" - 60"
1380 - 1530 mm

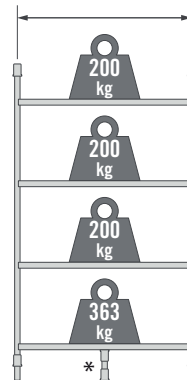

963 kg
Maximum
Unit Capacity

Corner Unit with 2 Dunnage Stands

30" - 48"
760 - 1220 mm

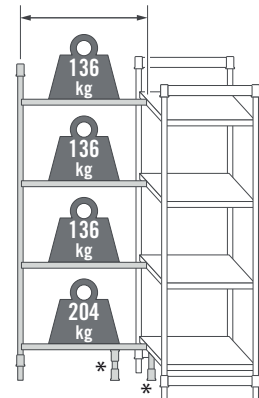

612 kg
Maximum
Unit Capacity

* Dunnage Stands add stability and increase weight bearing capacity on bottom shelf only. Add to any shelf length. Highly recommended for Starter Units 1380 mm (54") and longer, all Corner Units, U-Shape Units and units specified for heavier loads.



BASIC SERIES

72"
HEIGHT

Starter units include 2 factory assembled post kits and shelves. Add-on units include 1 factory assembled post kit and shelves. Units ship complete in 1 box.

Colour: Brushed Graphite

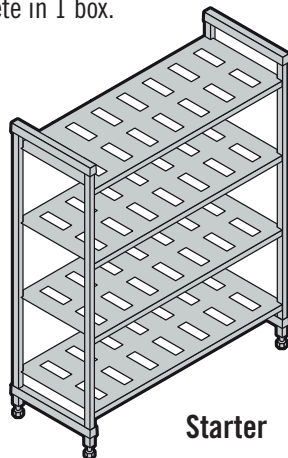

Starter

V4
4-Shelf Vented Stationary Units

18" DEPTH	DIMENSIONS (D x L x H)	STARTER CODE
	18" x 36" x 72"	CBU183672V4
	18" x 48" x 72"	CBU184872V4
	18" x 60" x 72"	CBU186072V4

21" DEPTH	DIMENSIONS (D x L x H)	STARTER CODE
	21" x 36" x 72"	CBU213672V4
	21" x 48" x 72"	CBU214872V4
	21" x 60" x 72"	CBU216072V4

24" DEPTH	DIMENSIONS (D x L x H)	STARTER CODE
	24" x 36" x 72"	CBU243672V4
	24" x 48" x 72"	CBU244872V4
	24" x 60" x 72"	CBU246072V4

Corner Connectors

Unique patented design ensures maximum shelf space utilization. Use 1 set per shelf to connect starter and add-on units in corners. Connect 4 or 5 intermediate shelves between 2 starter units (2 sets required per shelf). Available as a single set or 8 or 10 set packs.

CODE	DESCRIPTION
CBCC1	1 Set
CBCC8	8 Sets
CBCC10	10 Sets

Colour: Brushed Graphite

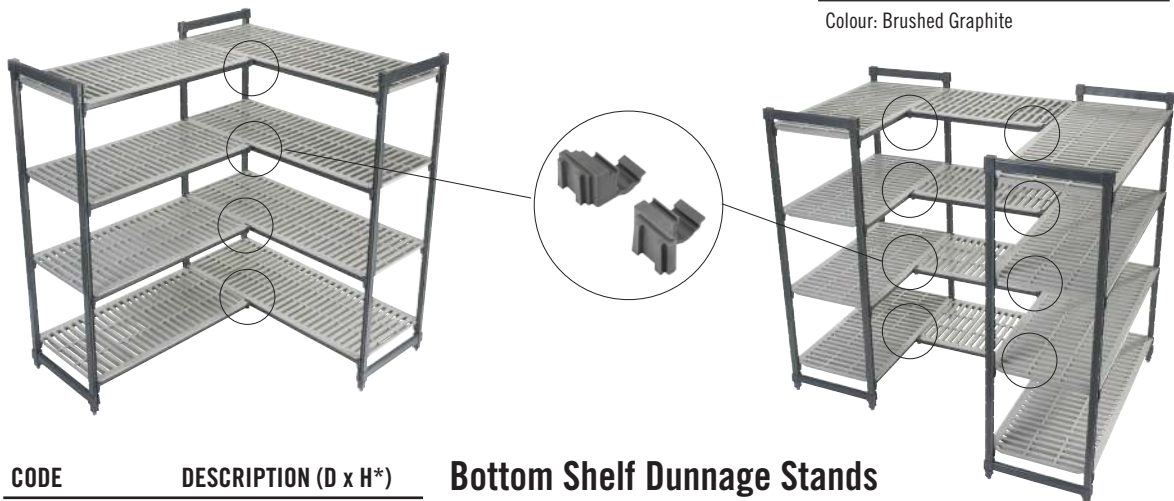

CODE	DESCRIPTION (D x H*)
Dunnage Stand - Low	
CBDS18H6	18" x 6.5"
CBDS21H6	21" x 6.5"
CBDS24H6	24" x 6.5"
Dunnage Stand - Tall	
CBDS18H10	18" x 10.5"
CBDS21H10	21" x 10.5"
CBDS24H10	24" x 10.5"

Case Pack: 1 Colour: Brushed Graphite

Bottom Shelf Dunnage Stands

Increase weight bearing capacity on bottom shelf only. Add to any shelf length. Highly recommended for starter units 54" and longer and all corner units, intermediate units and units specified for heavier load volume on and off bottom shelves.

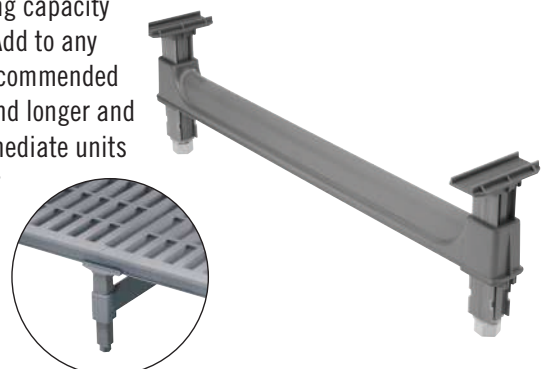

Camshelving® Wall Shelves and Shelf Extenders

Wall Shelves

- Expand storage space in kitchens, above work stations and sinks.
- Features virtually indestructible I-beam supports that hold up to 150 lbs. (68 kg) per shelf.
- Durable polypropylene withstands temperatures up to 190°F (88°C), and will not rust or corrode.
- Snap fit rail design allows shelves to snap on and off for easy cleaning.
- 2" (5 cm) backsplash and marine front edge controls spills and cross contamination.

Shelf Extenders

- Convert empty wall space into a functional storage area.
- Use with or without Camshelving Wall Shelves.
- Peg strips withstand temperatures up to 190°F (88°C), and will not rust or corrode.



14"
DEPTH



CODE	CSWS1436SK	CSWS1448SK	CSWS1436VK	CSWS1448VK
DESCRIPTION	36" x 14" Wall Shelf, Solid	48" x 14" Wall Shelf, Solid	36" x 14" Wall Shelf, Vented	48" x 14" Wall Shelf, Vented
EXTERIOR DIMENSIONS (CM)	L 36" x D 14" x H 13.5"	L 48" x D 14" x H 13.5"	L 36" x D 14" x H 13.5"	L 48" x D 14" x H 13.5"

18"
DEPTH



CODE	CSWS1836SK	CSWS1848SK	CSWS36EK	CSWS48EK
DESCRIPTION	36" x 18" Wall Shelf, Solid	48" x 18" Wall Shelf, Solid	36" Shelf Extender	48" Shelf Extender
EXTERIOR DIMENSIONS (CM)	L 36" x D 18" x H 13.5"	L 48" x D 18" x H 13.5"	L 35.5" x D 2" x H 15.5"	L 47.5" x D 2" x H 15.5"

S-Series Dunnage Racks

- Keep frozen, cold or dry inventory 12" (30,5 cm) safely off the floor.
- One piece construction and sturdy legs provide strength and stability.
- Heavy duty polypropylene is safe to -36°F (-38°C), and will not rust, corrode or bend.
- Choose slotted tops for maximum air circulation around perishable products.
- Solid tops catch spills for easy clean up.

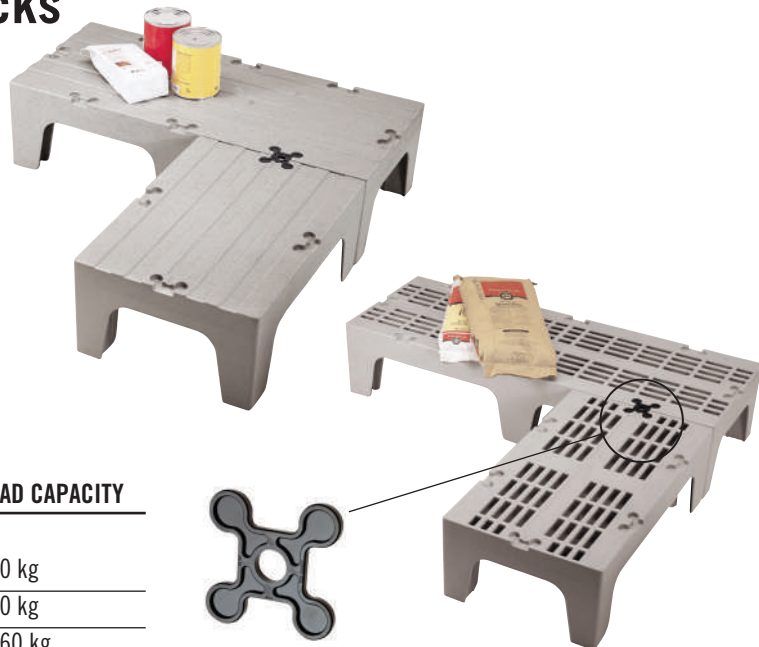

CODE	EXTERIOR DIMENSIONS (H x D x L)	LOAD CAPACITY
SOLID TOP		
DRS30	12" x 21" x 30"	680 kg
DRS36	12" x 21" x 36"	680 kg
DRS48	12" x 21" x 48"	1360 kg
DRS60	12" x 21" x 60"	1360 kg
SLOTTED TOP		
DRS300	12" x 21" x 30"	680 kg
DRS360	12" x 21" x 36"	680 kg
DRS480	12" x 21" x 48"	1360 kg
DRS600	12" x 21" x 60"	1360 kg

Case Pack: 1
Colour: Speckled Gray



Camlink®

Camlink connectors securely lock dunnage racks together for greater stability.

CODE	CASE PACK
DRLNK	6

Colour: Black





Aluminium High Density Shelving System





HIGH DENSITY SHELVING SYSTEM

The high density shelving system allows a better exploitation of the space increasing the storage capacity compared to a normal fixed shelving.
Build with 20 micron anodized aluminium, the shelving is entirely steel and ideal for cold storage.

Slats of the shelves are removable and dishwasher safe.
Developable indefinitely in width and length.

The slats are available in polyethylene or aluminium, certified for direct food contact.
Polyethylene is non-toxic, chemical resistant and with low hygroscopic absorption.
All hardware is stainless steel and is hidden within the structure itself.

Resistant to wear over time and insensitive to temperature changes.
The Eko Fit assembly does not require the use of any tool.

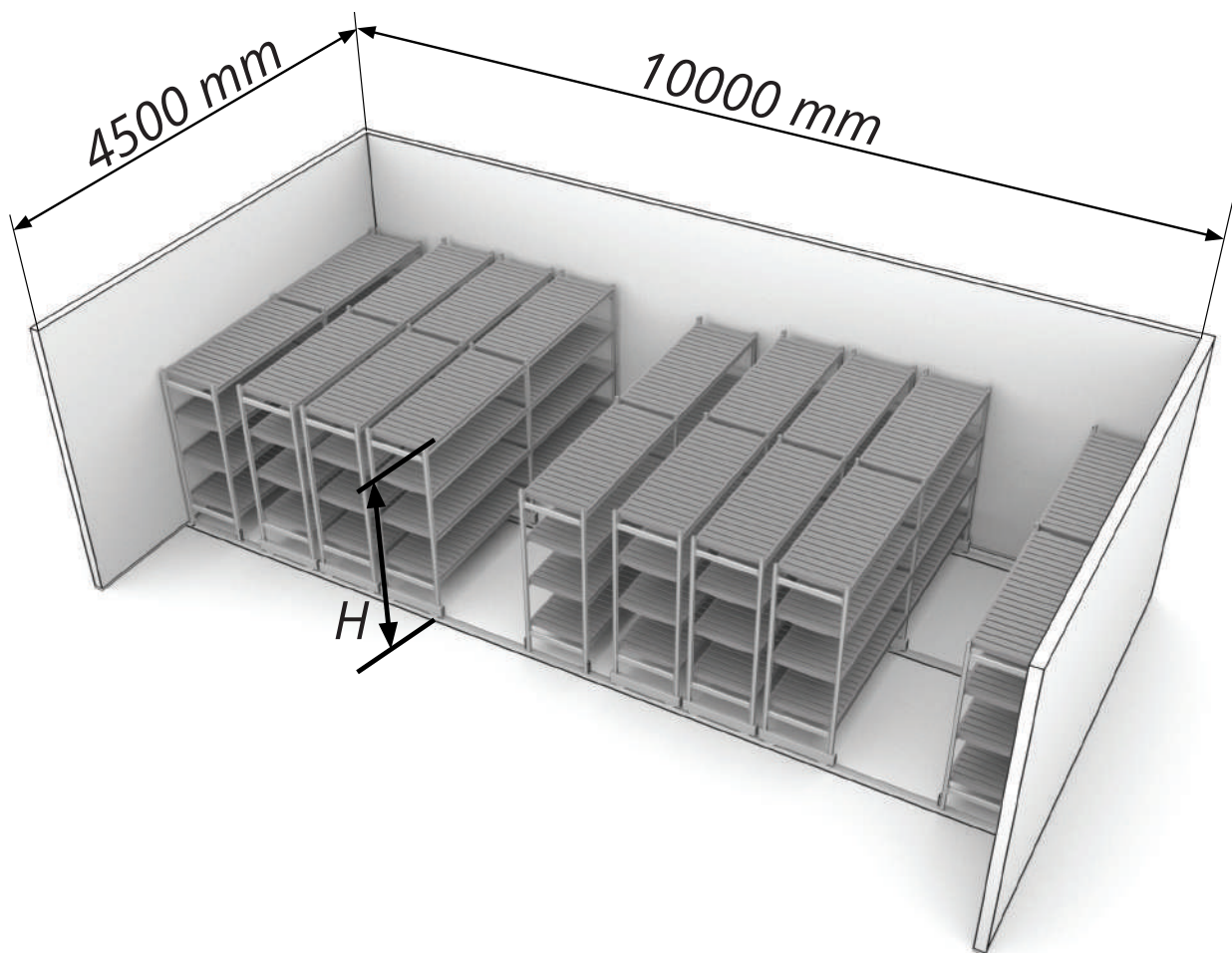

$H = 1650 / 1800 / 1950 / 2100 / 2250 \text{ mm}$



High density shelving system with lower rail

Dimensions in mm

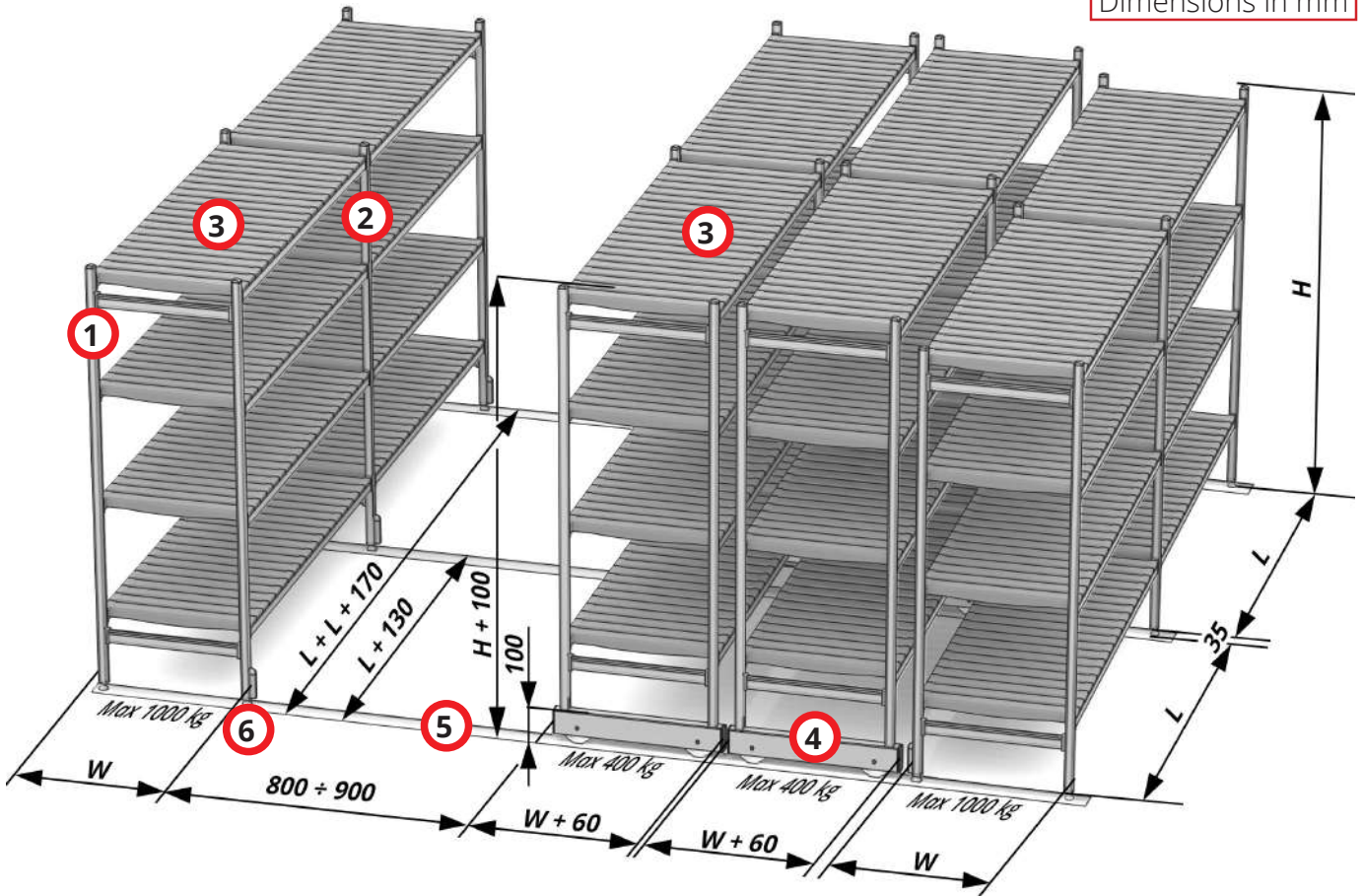

- 1 Terminal Frame
- 4 Stainless Steel Roller Unit
- 2 Central Frame
- 5 Lower Rail
- 3 Vented Shelf
- 6 Rubber Bumper

High density shelving system with lower rail - Components

ALUMINIUM TERMINAL FRAME H 1550 / 1700 / 1850 / 2000 / 2150 *

Pos.	Height mm (H)	Width mm (W)				
		300	375	450	525	600
1	1550	KFT298	KFT373	KFT448	KFT523	KFT598
	1700	KFT300	KFT375	KFT450	KFT525	KFT600
	1850	KFT301	KFT376	KFT451	KFT526	KFT601
	2000	KFT302	KFT377	KFT452	KFT527	KFT602
	2150	KFT303	KFT378	KFT453	KFT528	KFT603

* FOR EACH FRAME ALWAYS ADD P/N 2PCGHD

ALUMINIUM CENTRAL FRAME H 1550 / 1700 / 1850 / 2000 / 2150 *

Pos.	Height mm (H)	Width mm (W)				
		300	375	450	525	600
2	1550	KFC298	KFC373	KFC448	KFC523	KFC598
	1700	KFC300	KFC375	KFC450	KFC525	KFC600
	1850	KFC301	KFC376	KFC451	KFC526	KFC601
	2000	KFC302	KFC377	KFC452	KFC527	KFC602
	2150	KFC303	KFC378	KFC453	KFC528	KFC603

* FOR EACH FRAME ALWAYS ADD P/N 2PCGHD

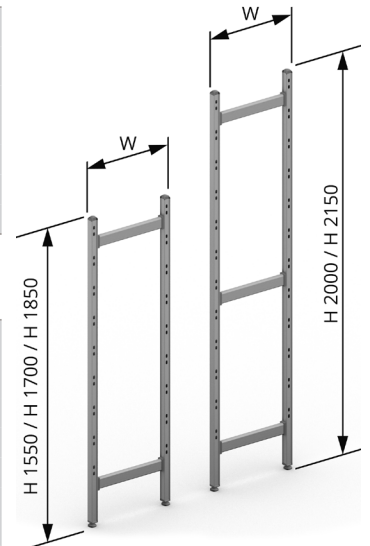

High Density Shelving System

VENTED ALUMINIUM SHELF WITH POLYETHYLENE SLATS Only for fixed frames

Pos.	Length mm (L)	Width mm (W)				
		300	375	450	525	600
3	700	KFS300	KFS375	KFS450	KFS525	KFS600
	775	KFS302	KFS377	KFS452	KFS527	KFS602
	850	KFS304	KFS379	KFS454	KFS529	KFS604
	925	KFS306	KFS381	KFS456	KFS531	KFS606
	1000	KFS308	KFS383	KFS458	KFS533	KFS608
	1075	KFS310	KFS385	KFS460	KFS535	KFS610
	1150	KFS312	KFS387	KFS462	KFS537	KFS612
	1225	KFS314	KFS389	KFS464	KFS539	KFS614
	1300	KFS316	KFS391	KFS466	KFS541	KFS616
	1375	KFS318	KFS393	KFS468	KFS543	KFS618
	1450	KFS320	KFS395	KFS470	KFS545	KFS620
	1525	KFS322	KFS397	KFS472	KFS547	KFS622



VENTED ALUMINIUM SHELF WITH POLYETHYLENE SLATS Only for mobile frames

Pos.	Length mm (L)	Width mm (W)				
		300	375	450	525	600
3	700	-	-	KFS450	KFS525	KFS600
	775	-	-	KFS452	KFS527	KFS602
	850	-	-	KFS454	KFS529	KFS604
	925	-	-	KFS456	KFS531	KFS606
	1000	-	-	KFS458	KFS533	KFS608
	1075	-	-	KFS460	KFS535	KFS610
	1150	-	-	KFS462	KFS537	KFS612
	1225	-	-	KFS464	KFS539	KFS614
	1300	-	-	KFS466	KFS541	KFS616
	1375	-	-	KFS468	KFS543	KFS618
	1450	-	-	KFS470	KFS545	KFS620
	1525	-	-	KFS472	KFS547	KFS622



STAINLESS STEEL ROLLER UNIT

Pos.	P/N	Description
4	BS45HD	Stainless steel roller unit width 450 mm
	BS52HD	Stainless steel roller unit width 525 mm
	BS60HD	Stainless steel roller unit width 600 mm

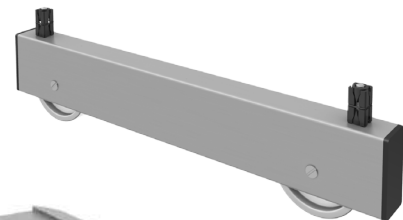

ALUMINIUM LOWER RAIL

Pos.	P/N	Description
5	SGP8HD	2 bars rail 8 m (4 + 4)
	SGPMHD	Tailor made rail

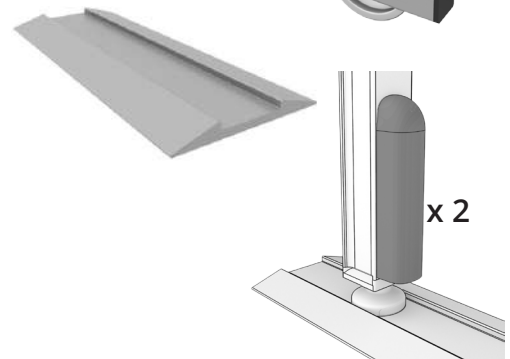

PARACOLPI IN GOMMA

Pos.	P/N	Description
6	2PCGH	2 rubber bumper for HD shelving system

In case you want to further secure the lower rail, you can order the couple end stops P/N 2AGPHD



Installation example

High density shelving system with lower rail

- ⊗ Cold room length = 3.5 metre, with lower rail.
- ⊗ Frames height H 1700 mm.
- ⊗ Shelf type = 600 x 1525 mm.
- ⊗ Load capacity 1000 kg for fixed frames.
- ⊗ Load capacity 400 kg for mobile frames.

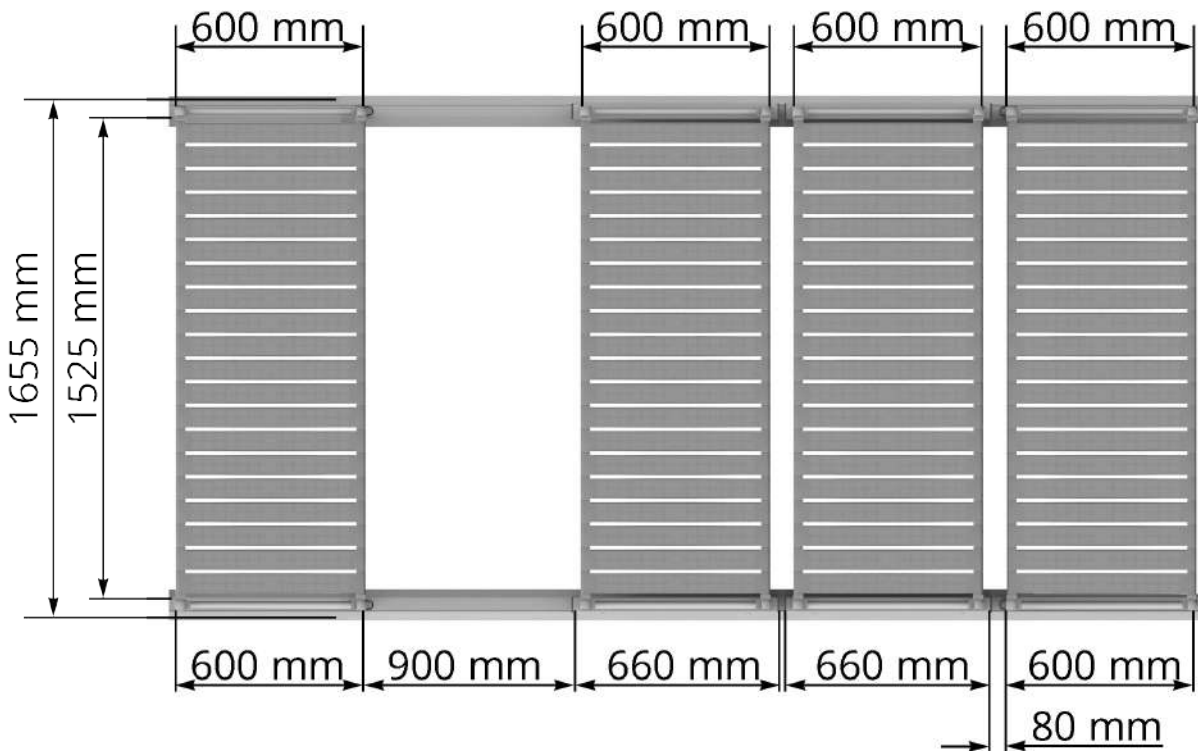
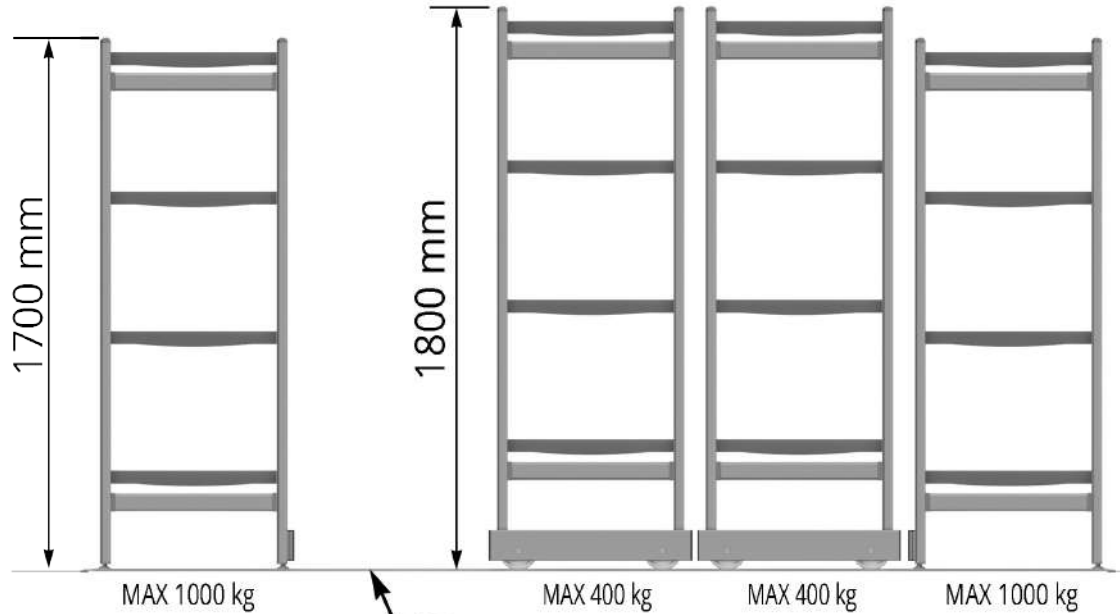

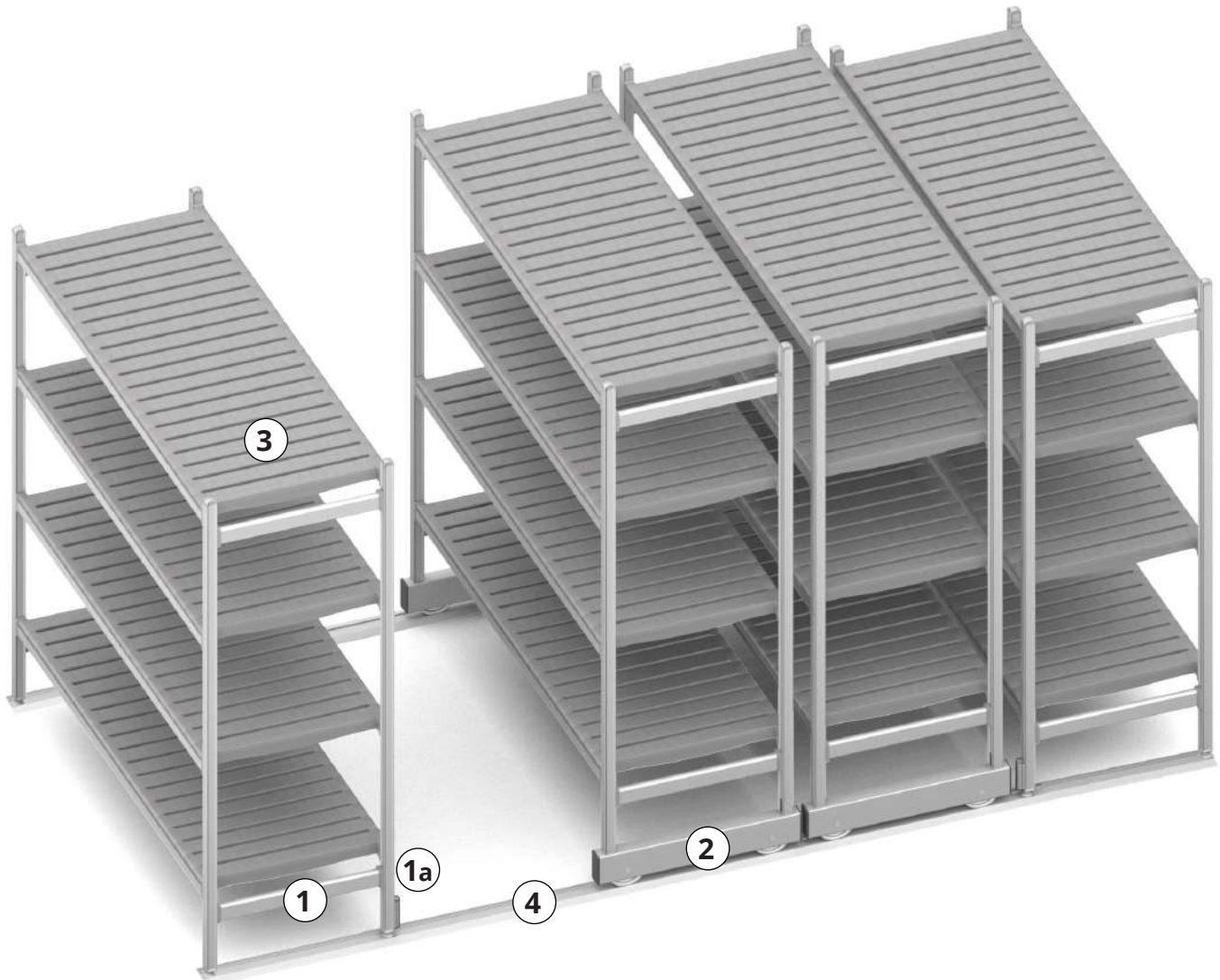

Components necessary for assembly

- 1** n° 4 **Terminal frame**
P/N KFT600, anodized aluminium.
- 1a** n° 2 **2 rubber bumper for HD shelving system**
P/N 2PCGHD, thermoplastic material
- 2** n° 4 **Roller unit**
P/N BS60HD, stainless steel.
- 3** n° 16 **Vented aluminium shelf with polyethylene slats**
P/N KFS622, 600x1525 mm, HDPE polyethylene.
- 4** 7 m **Tailor made lower rail (3.5 m x 2)**
P/N SGPMHD, anodized aluminium.

High density shelving system with upper rail

The Eko Fit high density shelving system with upper rail is the perfect product for those who do not want impediments on the ground. As the modular shelving is fully customizable in length, depth and height. The high density shelving system with upper rail is also very popular for its incredible strength and great load capacity.

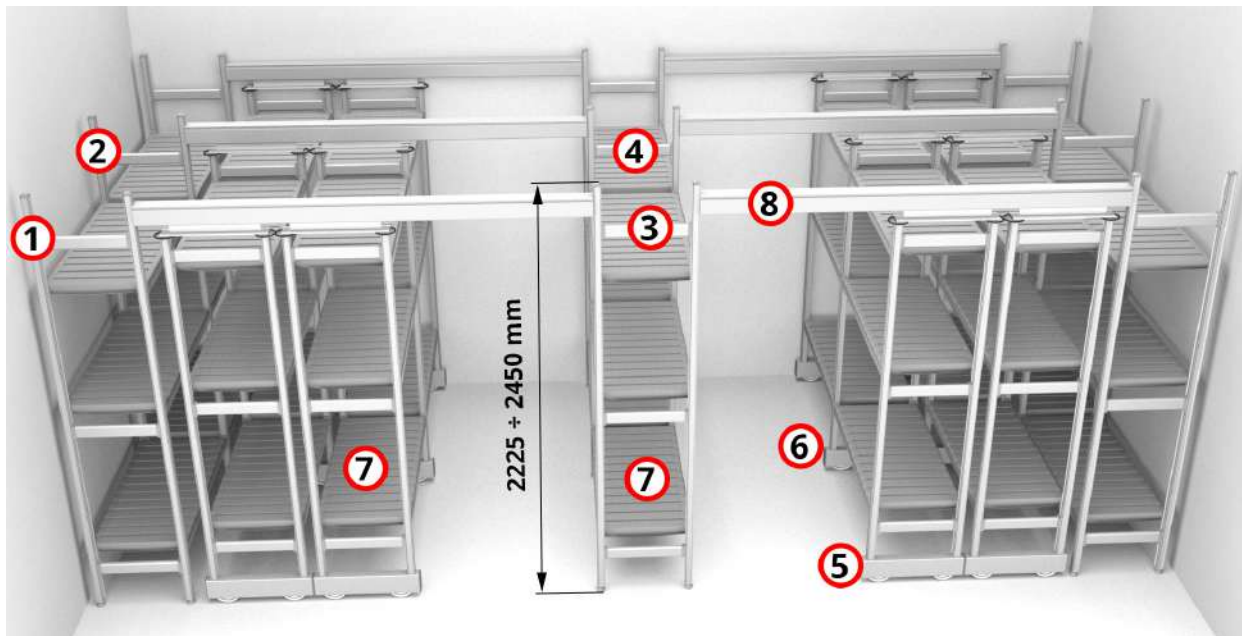

- ① Fixed terminal frame
- ⑤ Mobile terminal frame
- ② Fixed central frame
- ⑥ Mobile central frame
- ③ Fixed intermediate terminal frame
- ⑦ Vented shelf
- ④ Fixed intermediate central frame
- ⑧ Upper rail

High density shelving system with upper rail components

FIXED FRAME (with rubber bumpers included)

Pos.	P/N	Description
①	SFT300	Terminal fixed frame H 2450 - L 300
	SFT375	Terminal fixed frame H 2450 - L 375
	SFT450	Terminal fixed frame H 2450 - L 450
	SFT525	Terminal fixed frame H 2450 - L 525
	SFT600	Terminal fixed frame H 2450 - L 600
②	SFC300	Central fixed frame H 2450 - L 300
	SFC375	Central fixed frame H 2450 - L 375
	SFC450	Central fixed frame H 2450 - L 450
	SFC525	Central fixed frame H 2450 - L 525
	SFC600	Central fixed frame H 2450 - L 600
③	SFTI30	Terminal intermediate fixed frame H 2450 - L 300
	SFTI37	Terminal intermediate fixed frame H 2450 - L 375
	SFTI45	Terminal intermediate fixed frame H 2450 - L 450
	SFTI52	Terminal intermediate fixed frame H 2450 - L 525
	SFTI60	Terminal intermediate fixed frame H 2450 - L 600
④	SFCI30	Central intermediate fixed frame H 2450 - L 300
	SFCI37	Central intermediate fixed frame H 2450 - L 375
	SFCI45	Central intermediate fixed frame H 2450 - L 450
	SFCI52	Central intermediate fixed frame H 2450 - L 525
	SFCI60	Central intermediate fixed frame H 2450 - L 600

SPECIAL DIMENSIONS AVAILABLE BY REQUEST



High Density Shelving System

MOBILE FRAME

Pos.	P/N	Description
5	SMT450	Terminal mobile frame H 2000 - L 450
	SMT525	Terminal mobile frame H 2000 - L 525
	SMT600	Terminal mobile frame H 2000 - L 600
6	SMC450	Central mobile frame H 2000 - L 450
	SMC525	Central mobile frame H 2000 - L 525
	SMC600	Central mobile frame H 2000 - L 600

SPECIAL DIMENSIONS AVAILABLE BY REQUEST



VENTED ALUMINIUM SHELF WITH POLYETHYLENE SLATS

Only for fixed frames

Pos.	Length mm (L)	Width mm (W)				
		300	375	450	525	600
7	700	KFS300	KFS375	KFS450	KFS525	KFS600
	775	KFS302	KFS377	KFS452	KFS527	KFS602
	850	KFS304	KFS379	KFS454	KFS529	KFS604
	925	KFS306	KFS381	KFS456	KFS531	KFS606
	1000	KFS308	KFS383	KFS458	KFS533	KFS608
	1075	KFS310	KFS385	KFS460	KFS535	KFS610
	1150	KFS312	KFS387	KFS462	KFS537	KFS612
	1225	KFS314	KFS389	KFS464	KFS539	KFS614
	1300	KFS316	KFS391	KFS466	KFS541	KFS616
	1375	KFS318	KFS393	KFS468	KFS543	KFS618
	1450	KFS320	KFS395	KFS470	KFS545	KFS620
	1525	KFS322	KFS397	KFS472	KFS547	KFS622



VENTED ALUMINIUM SHELF WITH POLYETHYLENE SLATS

Only for mobile frames

Pos.	Length mm (L)	Width mm (W)				
		300	375	450	525	600
7	700	-	-	KFS450	KFS525	KFS600
	775	-	-	KFS452	KFS527	KFS602
	850	-	-	KFS454	KFS529	KFS604
	925	-	-	KFS456	KFS531	KFS606
	1000	-	-	KFS458	KFS533	KFS608
	1075	-	-	KFS460	KFS535	KFS610
	1150	-	-	KFS462	KFS537	KFS612
	1225	-	-	KFS464	KFS539	KFS614
	1300	-	-	KFS466	KFS541	KFS616
	1375	-	-	KFS468	KFS543	KFS618
	1450	-	-	KFS470	KFS545	KFS620
	1525	-	-	KFS472	KFS547	KFS622



UPPER RAIL

Pos.	P/N	Description
8	S90MCP	Aluminium tailor made upper rail H 90

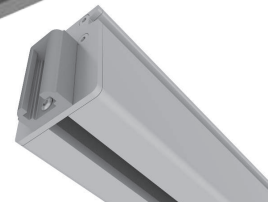

STORAGE & TRANSPORT

Stainless Steel GN 1/1 Trolley Dismantled Flat Pack 不锈钢份数盆车



CODE	9030501	9030503	9030502	9030504
DESCRIPTION	Single Low	Single Tall	Double Low	Double Tall
DIMENSIONS (l x d x h cm)	38 x 55 x 100	38 x 55 x 173.5	74 x 55 x 100	74 x 55 x 173.5
Capacity	Hold 6 x GN 1/1 x 2.5" Pan	Hold 14 x GN 1/1 x 2.5" Pan	Hold 12 x GN 1/1 x 2.5" Pan	Hold 28 x GN 1/1 x 2.5" Pan



Stainless Steel GN 2/1 Trolley 钢 2/1 份数盆车

CODE	9030505
DESCRIPTION	Single Tall
DIMENSIONS (l x d x h cm)	67 x 82 x 173.5
Capacity	Hold 28 x GN 1/1 x 2.5" Pan OR 14 x 2/1 x 2.5" GN



BLANCO

Stainless Steel GN Trolley, Dismantled Flat Pack 不锈钢餐盘车 (可拆除)

CODE	EXTERIOR DIMENSIONS (w x d x h)	CAPACITY
For GN 1/1 Pan		
9040601	46.0 x 61.4 x 16.45	Fits 18 x GN1/1 x 2.5" Pan
For GN 2/1 Pan		
9040602	66.2 x 73.3 x 16.45	Fits 18 x GN 2/1 x 2.5" Pan

Stainless Steel GN Trolley With Worktop **BLANCO** 不锈钢餐盘车

CODE	EXTERIOR DIMENSIONS (w x d x h)	CAPACITY
For GN 2/1 Pan		
9040501	66.2 x 73.3 x 84.5	Fits 8 x 2/1 GN x 2.5" Pan



Stainless Steel Tray / Rack Trolley 不锈钢台车

CODE	EXTERIOR DIMENSIONS (w x d x h)	CAPACITY
For 40 x 60 cm / 16" x 24" Baking Tray		
9030401	44 x 60.3 x 173.5 cm	Hold 15 x 40x60 cm Tray
For 45 x 65 cm / 18" x 26" Sheet Pan		
9030402	47 x 66 x 173.5 cm	Hold 15 x 45x65 cm Tray



Aluminium Tray Trolley 铝合金台车

CODE	EXTERIOR DIMENSIONS (w x d x h)	CAPACITY
For 40 x 60 cm / 16" x 24" Baking Tray		
9030301	47.1 x 60.3 x 185.2 cm	Hold 20 x 40x60 cm Tray



Aluminium Enclosed Tray Trolley 铝合金台车

CODE	EXTERIOR DIMENSIONS (w x d x h)	CAPACITY
For 40 x 60 cm / 16" x 24" Baking Tray		
9030302	62.8 x 47.1 x 171.2 cm	Hold 18 x 40x60 cm Tray



- 3 Side fully enclosed in Clear Acrylic Panel
- Top & Bottom Door for Easy retrieving

STORAGE & TRANSPORT

GN & Sheet Pan Plastic Food Trolley

食品运送车

CODE	9036602	9036601
DESCRIPTION	For GN 1/1 Pan	For 18"x26"cm Pan
DIMENSIONS (l x d x h cm)	47.3 x 60 x 172.4	80.6 x 60.3 x 172.4
Capacity	Hold 18 x GN 1/1 x 2.5" Pan	Hold 17 x 18"x26"x1" Pan



PVC Canvas Cover For Trolley with 2 Side Zip

数盆车套

CODE	ESTIMATED DIMENSIONS (w x d x h)
For GN 1/1 Single Tall Trolley	
9030510	41 x 58 x 165 cm
For GN 2/1 Single Tall Trolley	
9030512	70 x 85 x 165 cm
For 40x60cm / 16"x24" Trolley	
9030513	47 x 64 x 165 cm
For 45x65cm / 18"x26" Trolley	
9030514	50 x 69 x 165 cm



Disposable PP Covers for GN Trolley

数盆车套

CODE	ESTIMATED DIMENSIONS (w x d x h)	REMARK
For GN 2/1 Tall Trolley		
9036501	82 x 70 x 190 cm / sheet	Roll Of 100 Sheets



Plastic Wall Dispenser for PP Cover

CODE	ESTIMATED DIMENSIONS (l x w)	REMARK
9036502	90 x 20 cm	Roll Of 100 Sheets



Enclosed Stainless Steel Transport Trolley

CODE	DIMENSION (w x d x h cm)	Fit For
9030601	46 x 65 x 170	40x60 cm Tray
9030701	59 x 70 x 170	53x65 cm Pan (GN 2/1 Size)
9030801	38 x 58 x 170	32x53 cm Pan (GN 1/1 Size)

*Customized Sizes are available, please contact us for more details

Aluminium Rectangle Dolly

铝合金平台车



PRODUCT CODE	9030101	9030201
SAN NENG CODE	SN1987	SN1985
OVERALL DIA. (l x d x h cm)	62 x 42 x 14	72.5 x 47 x 14
HOLD TRAY SIZE (cm)	60x40 Tray	71.8x46 or 66x46 or 67.5x43.5 cm Tray
LOAD CAPACITY	250 kg	227 kg

*Customized Sizes are available, please contact us for more details

Stainless Steel Dolly

钢圆盘车 (有边用于钢桶)

CODE	DIAMETER (cm)	CODE	DIAMETER (cm)
9070137	37	9070152	52
9070142	42	9070156	56
9070147	47	9070162	62



Stainless Steel 2 / 3-Tier Trolley GOURMET STEEL

钢2/3层推车



3-Tier Round Pole Fixed

CODE	DIMENSION (l x w x h cm)	TYPE
9030801	70 x 40 x 79	Small
9030802	100 x 45 x 79	Large



2-Tier Round Pole Fixed

CODE	DIMENSION (l x w x h cm)	TYPE
9031201	75 x 40 x 83	Small
9031202	95 x 50 x 95	Large

3-Tier Round Pole Dismantled Flat Pack

CODE	DIMENSION (l x w x h cm)	TYPE
9031001	75 x 40 x 84	Small
9031002	85 x 45 x 90	Medium
9031003	95 x 50 x 95	Large



STORAGE & TRANSPORT

Stainless Steel 2 / 3-Tier Trolley **GOURMET** 钢2/3层推车 **STEEL**

2-Tier Round Pole Dismantled Flat Pack

CODE	DIMENSION (l x w x h cm)	TYPE
9031301	75 x 40 x 84	Small
9031302	85 x 45 x 90	Medium
9031303	95 x 50 x 95	Large



3-Tier Flat with One Side Open

CODE	DIMENSION (l x w x h cm)	TYPE
9030901	70 x 40 x 84	Small
9030902	79 x 45 x 86	Medium
9030903	100 x 50 x 86	Large

3-Tier Full Flat Dismantled Flat Pack

CODE	DIMENSION (l x w x h cm)	TYPE
9031101	70 x 40 x 84	Small
9031102	79 x 45 x 86	Medium
9031103	90 x 50 x 86	Large

Stainless Steel Side / Bar Trolley 方形钢酒水车

Square Dismantled Flat Pack

CODE	DIMENSION (l x w x h cm)	TYPE
9031401	45 x 40 x 76.5	Small
9031402	50 x 45 x 83	Medium
9031403	55 x 50 x 88	Large



Stainless Silverware & Trash Bin 钢桶



CODE	9031501	9031702
DESCRIPTION	Stainless Steel Silverware Bin	Stainless Steel Trash Bin
DIMENSIONS (l x d x h cm)	44 x 16 x 16	37.5 x 17.5 x 55
REMARK	Fit 9031001 / 9031002 / 9031003 / 9031301 / 9031302 / 9031303 Trolley	

Plastic Utility Service Cart 3层推车



CODE	9031601-XX	9032001-XX	9031801-XX
DESCRIPTION	3-Tier Small Utility	2-Tier Small Utility	3-Tier Large Utility
DIMENSIONS (l x d x h cm)	71 x 42 x 90	71 x 42 x 90	89 x 54 x 94



*Available Colour for small utility cart only

■ BK ■ GY ■ BG

When ordering Black Colour add **CODE** suffix to item number
(example: 9031601-BK)

*Available Colour for large utility cart only

■ BK ■ GY

When ordering Black Colour add **CODE** suffix to item number
(example: 9031801-BK)

Optional Accessories for Utility Cart 垃圾箱, 餐具盒



CODE	9031703	9031704	9031901-XX
DESCRIPTION	9.5 Ltr Silverware Bin	30 Ltr Trash Bin	Shelf Panel Only for Large Utility Cart Only
DIMENSIONS (l x d x h cm)	33.7 x 23.1 x 18.7	33.7 x 23.1 x 56	80 x 45 x 24
REMARK			1 Long & 2 Short Panel



*Available Colour for shelf panel only

■ BK ■ GY

When ordering Black Colour add **CODE** suffix to item number
(example: 9031901-BK)

KD Service Cart And KD Utility Cart

- Versatile, durable and economically-priced carts.
- Marine rails and lightly-textured polypropylene shelves keep contents in place.
- Aluminum uprights ensure stability.
- Ships “knocked down” to minimize shipping costs.
- Easy to assemble.



PRODUCT CODE	9032201	9032101	CAMBRO
CAMBRO CODE	BC331KD	BC340KD	
DESCRIPTION	Small Utility Cart	Large Utility Cart	
OVERALL DIA. (l x d x h cm)	83.5 x 41.3 x 96.5	101.5 x 54 x 95	
SHELF DIA. (l x d x h cm)	62 x 40 x 30	80 x 52 x 29.8	
LOAD CAPACITY	136 kg	180 kg	

Optional Accessories for KD Cart

垃圾箱, 餐具盒



PRODUCT CODE	9031705	9031706	9031902-XX	CAMBRO
CAMBRO CODE	BC331KDTC	BC331KDSH	BC340KDP	
DESCRIPTION	30 Ltr Trash Bin	9.5 Ltr Silverware Bin	Shelf Panel Only for KD340 Cart Only	
Dimension (l x w x h cm)	33 x 24 x 56	33 x 24 x 18.5	80.3 x 45 x 29.8	
REMARK			1 Long & 2 Short Panel	

Heavy Duty Utility Transport Cart



*Available Colour

■ BK ■ GY

When ordering Shelf add **CODE** suffix to item number (example: 9032601-BK)



CODE	9032601-XX	9032701-XX	9033001
DESCRIPTION	Small Utility	Large Utility	Large Utility 5 Tier
DIMENSIONS (l x d x h cm)	83 x 47.3 x 95.5	101 x 51 x 96	101 x 51 x 134

*Back Colour Only

Optional Accessories for Utility Cart

垃圾箱, 餐具盒



270 Degree Openly Enhanced Operation Usage

Covered Trash Bin Enhanced appearance & Cleanliness

Wide opening facilitates maneuver and keeps handles clean



*Available Colour

■ BK ■ GY

When ordering Shelf add **CODE** suffix to item number (example: 9032801-BK)

CODE	9033002	9032801-XX	9032901-XX
DESCRIPTION	Silver Ware Bin with Cover	Shelf Panel Only for Small Utility Cart Only	Shelf Panel Only for Large Utility Cart Only
DIMENSIONS (l x d x h cm)	43 x 32 x 56		
REMARK		1 Long & 2 Short Panel	1 Long & 2 Short Panel

Polyethylene Service Carts

- All-purpose versatile, durable and dependable workhorses.
- Ideal for use on the receiving dock or setting up and bussing tables.
- Made of one-piece, polyethylene with molded-in handles and shelves.
- Choose from models with open or enclosed sides.

Casters Diameter & Type for All Carts: 7.6cm, 2 Fixed, 2 Swivel & 1 w/brake



PRODUCT CODE	9033401
CAMBRO CODE	BC225
OVERALL DIA. (l x d x h cm)	71 x 41 x 82
SHELF DIA. (l x d x h cm)	56 x 39.5 x 29
LOAD CAPACITY	159 kg



PRODUCT CODE	9033501
CAMBRO CODE	BC235
OVERALL DIA. (l x d x h cm)	95 x 55 x 88
SHELF DIA. (l x d x h cm)	79 x 52 x 29
LOAD CAPACITY	227 kg



PRODUCT CODE	9033601
CAMBRO CODE	BC230
OVERALL DIA. (l x d x h cm)	84.5 x 51 x 88
SHELF DIA. (l x d x h cm)	69 x 49.5 x 29
LOAD CAPACITY	227 kg



Enclosed Model
9033701

PRODUCT CODE	9033601	9033701
CAMBRO CODE	BC230	BC330
OVERALL DIA. (l x d x h cm)	84.5 x 51 x 88	84.5 x 51 x 88
SHELF DIA. (l x d x h cm)	69 x 49.5 x 29	69 x 46.5 x 29
LOAD CAPACITY	227 kg	227 kg

Optional Accessories for Service Carts

垃圾箱, 餐具盒



PRODUCT CODE	9033801
CAMBRO CODE	BC11TC
DESCRIPTION	42 Ltrs Trash Container
DIMENSION (l x w x h cm)	35 x 20.6 x 53.7



PRODUCT CODE	9033901
CAMBRO CODE	BC11115SH
DESCRIPTION	6.6 Ltrs Silverware Bin
DIMENSION (l x w x h cm)	36.8 x 15.2 x 13.7

Tray & Dish Cart / Tray & Silverware Carts

Tray & Dish Cart

- Open storage compartment holds a wide variety of plates and trays.
- Use with or without detachable cutlery station.
- Made of easy-to-clean polyethylene that won't rust, peel or corrode.
- Rounded, molded-in corners protect furniture and walls.
- Molded-in handles and heavy-duty 15.2 cm swivel casters ease maneuvering.
- Casters: 15.2 cm all swivel, 2 with brakes

Vinyl Cover for Sanitary storage is included

PRODUCT CODE	9034101-XX
CAMBRO CODE	TDCR12
DESCRIPTION	Cutleries & Trays Combination
DIMENSION (l x w x h cm)	97 x 58 x 105

*Available Colour

- DBR (dark brown)
- SPGY (speckled gray)

When ordering Dark Brown Colour add **CODE** suffix to item number (example: 9035401-DBR)



Tray & Silverware Cart

- Use to neatly organize trays and accessories for self-service.
- Includes eight clear polycarbonate food pans to hold flatware, napkins and non-perishable condiments.
- Casters: 15.2 cm all swivel, 2 with brakes

Vinyl Cover for Sanitary storage is included

PRODUCT CODE	9034001-XX
CAMBRO CODE	TDC1418
DESCRIPTION	Complete with Pans & Cover
MAXIMUM TRAY SIZE	36 x 46 cm
MAXIMUM TRAY CAPACITY	180 - 200 In two stacks
DIMENSION (l x w x h cm)	82 x 54 x 116

*Available Colour

- DBR (dark brown)
- SPGY (speckled gray)

When ordering Dark Brown Colour add **CODE** suffix to item number (example: 9034001-DBR)



Adjustable Tray & Dish Cart

- Use to store a wide variety of plates and trays.
- Move two adjustable dividers into position easily to secure trays and plates.
- Made of durable polyethylene that cushions plates and trays to prevent chipping.
- Easy to clean and won't dent, rust, chip or break.
- Maximum load capacity: 227 kg.
- Casters: 15.2 cm all swivel, 2 with brakes

Vinyl Cover for Sanitary storage is included

PRODUCT CODE	9035401-XX
CAMBRO CODE	TDC30
NUMBER OF DIVIDER	2
PLATES PER COLUMN	Hold 45 - 60 plates
TRAYS PER COLUMN	80 Trays of 35 x 46cm
DIMENSION (l x w x h cm)	59 x 99 x 88

*Available Colour

- DBR (dark brown)
- SPGY (speckled gray)

When ordering Dark Brown Colour add **CODE** suffix to item number (example: 9035401-DBR)





Heavy Duty Utility Cart

- Sturdy structural foam construction won't rust, dent, chip or peel.
- Rounded corners protect walls and furniture.
- Lightweight and maneuverable.
- Large 4" (10.2 cm) non-marking swivel casters.
- Sturdy, structural foam construction won't rust, dent, chip or peel.
- Large, non-marking casters.
- Ergonomically designed push handle provides optimum hand placement and push height improving control and worker safety
- Molded-in storage compartments, holsters, hooks, and notches
- Molded-in customizable fittings
- High density structural resin construction
- Easy-access bottom shelf
- Best-in-class casters to meet the most demanding environments



2-Shelves with Lipped Model

PRODUCT CODE	9034201-XX	9034202-XX	9034203-XX
RUBBERMAID CODE	4500-88	4520-88	4546
DESCRIPTION	Small	Medium	Large
MAX LOAD CAPACITY (kg)	226.8	226.8	340.2
DIMENSION (l x w x h cm)	99 x 45.4 x 84.5	114.9 x 65.7 x 84.5	137.2 x 64.1 x 84.5

*Available Colour

■ BK

■ BG

When ordering Black Colour add **CODE** suffix to item number
(example: 9034201-BK)

- Perfect for transporting materials, supplies, and heavy loads in almost any environment
- Ergonomically designed push handle provides optimum hand placement and push height improving control and worker safety
- Molded-in storage compartments, holsters, hooks, and notches
- Molded-in customizable fittings
- High density structural resin construction
- Easy-access bottom shelf
- Best-in-class casters to meet the most demanding environments



Flat Shelf Model



PRODUCT CODE	9034401-XX	9034402-XX
RUBBERMAID CODE	4505-00	4525-00
DESCRIPTION	Small	Medium
MAX LOAD CAPACITY (kg)	226.8	226.8
DIMENSION (l x w x h cm)	97.8 x 43.8 x 96.8	111.4 x 65.7 x 84.6

*Available Colour

■ BK

■ BG

When ordering Black Colour add **CODE** suffix to item number
(example: 9034401-BK)

BITBAR Utility Cart 多用途工具推车

- Innovative design for easy transporting of any items.
- Sturdy structural foam construction won't rust, dent chip or peel easily
- Molded in Storage compartments and cup holders at the handle enhances storages of small items & tools
- Ergonomically design handle provide comfort & easy maneuverability



2-Shelves with Lipped Model

3-Shelves with Lipped

PRODUCT CODE	9036201	9036202	9036203
MANUFACTURE CODE	4044	4041	4043
DESCRIPTION	Small	Medium	Medium 3-Shelves
MAX LOAD CAPACITY (kg)	230	230	230
DIMENSION (l x w x h cm)	97.8 x 43.5 x 98.7	115 x 64.1 x 98.7	115 x 64.1 x 98.7

2-Flat Shelf Model

PRODUCT CODE	9036301
MANUFACTURE CODE	4045
DESCRIPTION	Small
MAX LOAD CAPACITY (kg)	230
DIMENSION (l x w x h cm)	97.8 x 43.5 x 96.8



Oeazy Platform Trolley

- Perfect for transporting of heavy loads in any environment
- User friendly handles help to maneuver the cart & ensure the safety of operators
- Molded-in structure add strength & durability & helps to prolong the service life
- Textures surfaces for non-skid & safe transporting of loads
- Grooves closes to edges help prevent small items from rolling out
- Large Platform size of 121.9 x 61cm



PRODUCT CODE	9070601
MANUFACTURE CODE	4413
DESCRIPTION	15cm PP Castors Provided
MAX LOAD CAPACITY (kg)	900
DIMENSION (l x w x h cm)	101.9 x 61 x 100.6



Complete with 4 Sided Fence

PRODUCT CODE	9070602
MANUFACTURE CODE	4463
DESCRIPTION	20cm TPR Castors Provided
MAX LOAD CAPACITY (kg)	900
DIMENSION (l x w x h cm)	142.2 x 61 x 105.4

STORAGE & TRANSPORT

Utility Platform Trolley

- Easy transports of large bulky items & foldable handles provides easy storage.
- Sturdy structural foam deck won't rust, dent, chip or peel
- Non-Skid platform surface helps prevent load shifting
- Three Position handle allows users to push, pull or fold flat for use as a dolly
- Non marking Wheels are provided

PRODUCT CODE	9070501
MANUFACTURE CODE	4482
DESCRIPTION	12.5cm Castors Provided
MAX LOAD CAPACITY (kg)	230
DIMENSION (l x w x h cm)	97.8 x 43.5 x 96.8



Heavy Duty Platform Trolley

PRODUCT CODE	9070212	9070230
DESCRIPTION	Small, Foldable Handle	Medium, Foldable Handle
PLATFORM TYPE	Gray Plastic	Gray Plastic
MAX LOAD CAPACITY (kg)	120	300
DIMENSION (l x w x h cm)	71 x 46 x 90	92 x 59 x 110



PRODUCT CODE	9070312	9070330	9070350
DESCRIPTION	Small, Foldable Handle	Medium, Foldable Handle	Large, Non Foldable Handle
PLATFORM TYPE	Metal	Metal	Metal
MAX LOAD CAPACITY (kg)	150	300	500
DIMENSION (l x w x h cm)	71 x 46 x 90	92 x 59 x 110	125 x 79 x 115

S-Series Adjustable Dish Caddy S系列可调式盘碟车

- Store one size dish or a combination of different sizes in a single caddy.
- Features easy-to-adjust column towers.



Holds plates and bowls from 11,7 to 33 cm

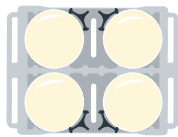

Plate sizes: ø 23,5 cm to 33 cm
4 Columns (60 each)
Total Capacity: 240

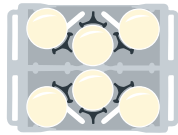

Plate sizes: ø 18,42 cm to 23,5 cm
6 Columns (60 each)
Total Capacity: 360

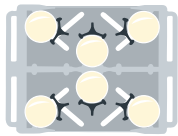
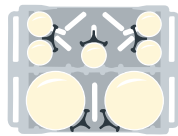
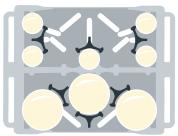

Plate sizes: ø 14,6 cm to 18,42 cm
6 Columns (45 each)
Total Capacity: 270



2 Columns: ø 23,5 cm to 33 cm (60 each)
5 Columns: ø 12,6 cm (45 each)
Total Capacity: 345



3 Columns: ø 18,42 cm to 23,5 cm (60 each)
5 Columns: ø 11,75 cm (45 each)
Total Capacity: 405

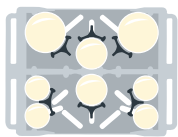

2 Columns: ø 18,42 cm to 23,5 cm (60 each)
2 Columns: ø 14,6 cm to 18,42 cm (45 each)

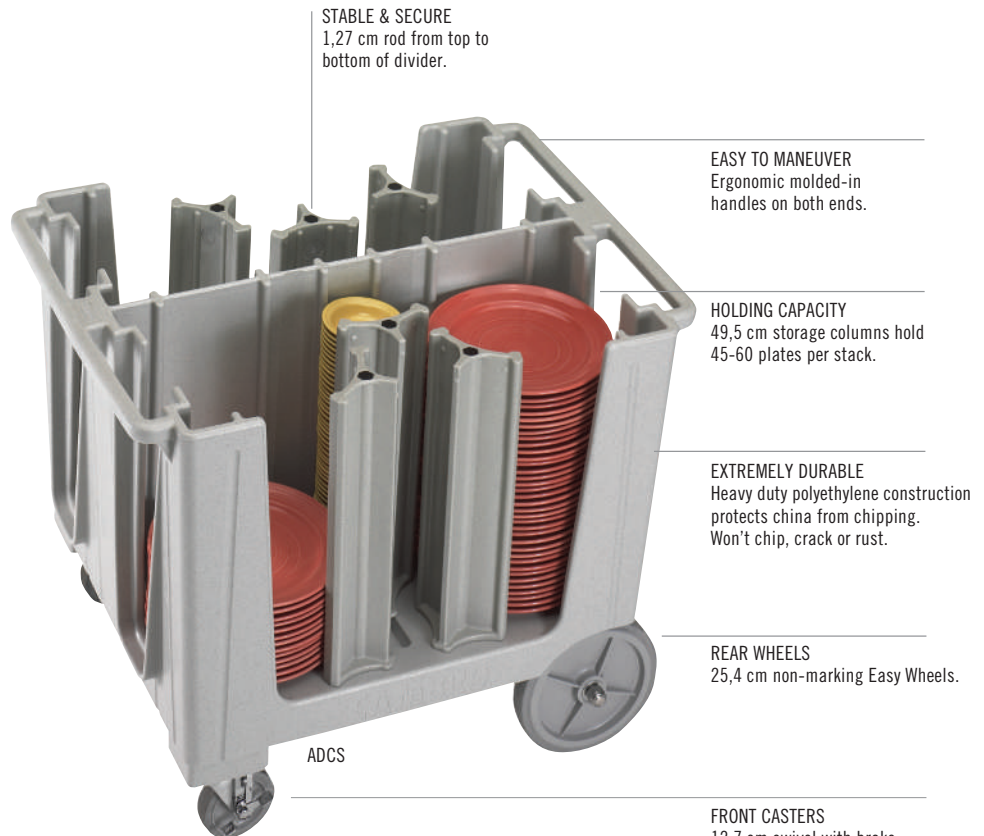

STABLE & SECURE
1,27 cm rod from top to bottom of divider.

EASY TO MANEUVER
Ergonomic molded-in handles on both ends.

HOLDING CAPACITY
49,5 cm storage columns hold 45-60 plates per stack.

EXTREMELY DURABLE
Heavy duty polyethylene construction protects china from chipping. Won't chip, crack or rust.

REAR WHEELS
25,4 cm non-marking Easy Wheels.

ADCS

FRONT CASTERS
12,7 cm swivel with brake.



A 2 cm plated steel rear axle allows for 227 Kg load capacity.



Vinyl cover included with every dolly for sanitary storage.

PRODUCT CODE	9034701-XX
CAMBRO CODE	ADCS
NUMBER OF DIVIDER	6
PLATES PER COLUMN	45 - 60
DIMENSION (l x w x h cm)	73 x 96 x 81
WEIGHT (kg)	60.69

*Available Colour

- BK (black)
- SPGY (speckled grey)
- DBR (dark brown)

When ordering Black Colour add **CODE** suffix to item number (example: 9034701-BK)

Versa Adjustable Dish Caddy

可调式盘碟车

Unlimited Versatility, Great Capacity Adjustable Dish Caddy

- Great capacity with a range of 180 to 480 plates at a capacity of 45-60 plates per column, depending on the brand of the plates.
- Plates Size ranges from 11 - 33cm Round Plates Or 20.3 - 28.8cm Square Plates
The versatile design allows many possible configurations for your dinnerware:
- Ergonomic design with handles built flush into either side wall make the ADC33 compact and comfortable to handle.
- Durable, polyethylene exterior will not rust, crack, dent or chip
- The ADC33 features four 6" swivel casters with brakes at each corner, and one rigid caster in the center of the unit which makes it easy to maneuver, even when the caddy is fully loaded!

PRODUCT CODE	9034702
CAMBRO CODE	ADC33
NUMBER OF DIVIDER	6
PLATES PER COLUMN	45 - 60
DIMENSION (l x w x h cm)	98.43 x 76.2 x 83.82
WEIGHT (kg)	34.9



Vinyl Covers Included in All Dish Caddies

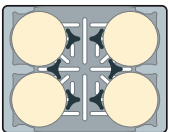

6 Dividers:
4 stacks (11-33 cm)
Rounds

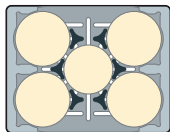

6 Dividers:
4 stacks (11-33 cm) Rounds +
1 stack (17.5-30 cm) Rounds

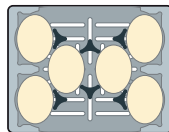

6 Dividers:
6 stacks
(20,3-29,2 x 12,7-21,9 cm) Ovals

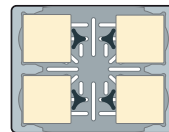

4 Dividers:
4 stacks (25-28,8 cm)
Squares

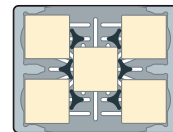

6 Dividers:
5 stacks (24-27,9 cm)
Squares

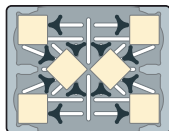

12 Dividers*:
6 stacks (15,2-20,3 cm)
Squares or Rounds

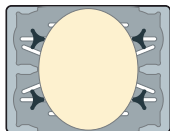

6 Dividers:
4 stacks (11-33 cm)
Rounds

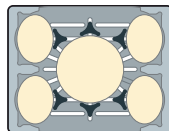

4 Dividers:
1 stack (35-73,6 cm) long x
up to (59,9 cm) wide Oval trays

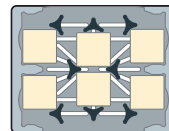

8 Dividers*:
6 stacks (20,3 cm)
Medium Squares

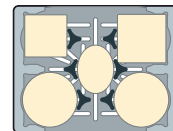

6 Dividers:
2 stacks (33,7 cm)
Large Rounds,
1 stack (25,4 cm)
Medium Squares,
1 stack (29,2 cm)
Large Squares,
1 stack (29,2 x 21,9 cm)
Medium Ovals

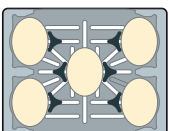

6 Dividers:
5 stacks (29,2 x
21,9 cm) Ovals

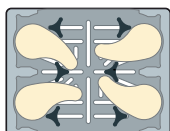

6 Dividers:
4 stacks Custom
Plates

Dish Caddies

盘碟车

Poker Chip Style Dish Caddies

- Use to store and protect valuable dishware.
- Dividers are molded into the body in a standard poker chip design.
- Made of durable polyethylene that protects plates from chipping.
- Open access from two sides for easy loading and unloading.
- Rounded corners inside and out protect dishware, furniture and walls.

*Available Colour for
Poker Chip Caddies

- BK (black)
- GNGY (granite grey)
- DBR (dark brown)

When ordering Slate Blue Colour
add **CODE** suffix to item number
(example: 9035001-SLBL)



POKER CHIP DISH CADDIES SERIES

PRODUCT CODE	9035001-XX	9035101-XX	9035201-XX
CAMBRO CODE	DC575	DC700	DC825
PLATES SIZE RANGE (cm & Inch)	14.6 (5" - 5.5")	14.9 - 17.8 (7" Plate)	18.1 - 21 (8" Plate)
NUMBER OF COLUMN	6	6	4
PLATES PER COLUMN	45 - 60	45 - 60	45-60
DIMENSION (l x w x h cm)	83 x 60 x 81	83 x 60 x 81	73 x 60.5 x 81.5

Vinyl Covers Included in All Dish Caddies

Versa Dish Caddies

- Secure, high-capacity storage to protect both square and round plates.
- Durable, polyethylene exterior will not rust, crack, dent or chip.
- Poker chip style offers greater access for easy plate removal.
- A 2 cm plated steel rear axle allows for 227 kg load capacity.
- Molded-in handles on both ends for easy transporting.
- 12,7 cm front swivel casters with brake and 25,4 cm non-marking rear wheels ease maneuvering.
- No assembly required.

*Available Colour for
Versa Dish Caddies

- BK (black)
- SPGY (speckled grey)
- DBR (dark brown)

When ordering Black Colour add
CODE suffix to item number
(example: 9034801-BK)

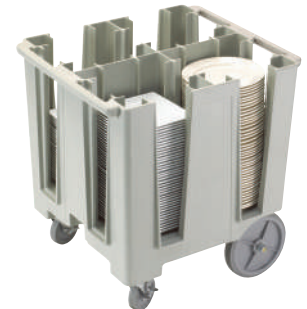
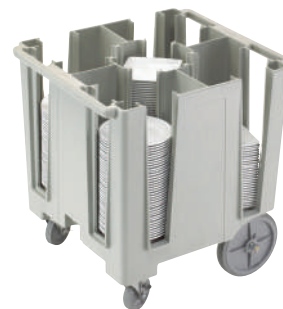

POKER CHIP DISH CADDY

PRODUCT CODE	9035301-XX
CAMBRO CODE	DC1225
PLATES SIZE RANGE (cm)	28.9 - 31.1 (12" Plate)
NUMBER OF COLUMN	4
PLATES PER COLUMN	45 - 60
DIMENSION (l x w x h cm)	83 x 70 x 81.5

Vinyl Covers Included in All Dish Caddies

VERSA DISH CADDIES SERIES

PRODUCT CODE	9034801-XX	9034901-XX
CAMBRO CODE	DCS950	DCS1125
PLATES SIZE RANGE (cm)	21.3 - 24.1(9" Plate) 18.4 - 20.5 For Square	24.4 - 28.6 (11.25" plate) 21.3 - 24.1 For Square
NUMBER OF COLUMN	5	4
PLATES PER COLUMN	45 - 60	45-60
DIMENSION (l x w x h cm)	69 x 78 x 81	69 x 78 x 81

Vinyl Covers Included in All Dish Caddies

CAMBRO®

Camrack® 4-in-1 Warewashing System

The Camrack® System will protect glassware and keep it clean until the next event, eliminating the need for rewashing.

Efficient Washing

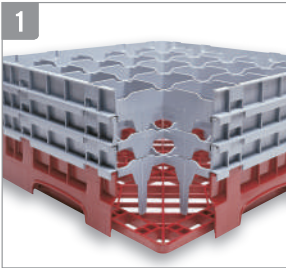

Open inside compartments provide thorough circulation of water and cleaning solutions and promote quick and thorough drying.

Long-lasting polypropylene Camracks are built to withstand chemicals and high temperatures up to 200°F (93°C).

Sanitary Storage



Closed outer walls keep fingers and contaminants out and reduce risk of breakage and injury. The Camrack cover and Camdolly make this system completely enclosed. Glassware stays clean when in storage, so operators will only have to wash items once.

Inventory Control



A variety in base rack colors help identify at a glance both contents and quantity per rack. Available in 10 colors.

Safe, Sanitary Transportation



Camracks can be transported across large campuses or to off-site locations in one single unit.

Easy to grip handles and smooth overlapping sides facilitate safe handling.

Camrack Cover Seals from the Top and Camdolly® Seals from the Bottom.



Camracks interstack with racks from major manufacturers.

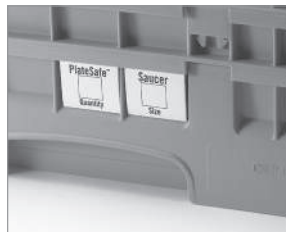

Content labeling options include one-color custom hot stamping or pre-printed clips that are added at factory during assembly.



Camracks are covered by one or more of the following patents: Full Base Dish Rack D412,607. Half Base Dish Rack D404,176. Half Dish Rack Extender D400,321. Enlarged Dish Rack Extender D399,614. Dish Rack with Extender 5,934,486 Utility Patent. Pronged Base Dish Rack D403,472.

Cambro Glass Rack

49 Compartment

Maximum Glass Diameter: 6.2 cm

Overall Rack Diameter: 50 x 50 cm

Individual Comp Diameter: 6.2 x 6.2 cm

MAX GLASS HEIGHT (CM)	9.2	13.3	17.4	21.5	25.7	29.8
PRODUCT CODE	9061401-xx	9061402-xx	9061403-xx	9061404-xx	9061405-xx	9061406-xx
CAMBRO CODE	49S318	49S434	49S638	49S800	49S958	49S1114
OVERALL RACK Height (cm)	14.3	18.4	22.5	26.7	30.8	34.9
NO. OF EXTENDER	1	2	3	4	5	6



36 Compartment

Maximum Glass Diameter: 7.3 cm

Overall Rack Diameter: 50 x 50 cm

Individual Comp Diameter: 7.3 x 7.3 cm

MAX GLASS HEIGHT (CM)	9.2	13.3	17.4	21.5	25.7	29.8
PRODUCT CODE	9061501-xx	9061502-xx	9061503-xx	9061504-xx	9061505-xx	9061506-xx
CAMBRO CODE	36S318	36S434	36S638	36S800	36S958	36S1114
OVERALL RACK Height (cm)	14.3	18.4	22.5	26.7	30.8	34.9
NO. OF EXTENDER	1	2	3	4	5	6



25 Compartment

Maximum Glass Diameter: 8.7 cm

Overall Rack Diameter: 50 x 50 cm

Individual Comp Diameter: 8.9 x 8.9 cm

MAX GLASS HEIGHT (CM)	9.2	13.3	17.4	21.5	25.7	29.8
PRODUCT CODE	9061601-xx	9061602-xx	9061603-xx	9061604-xx	9061605-xx	9061606-xx
CAMBRO CODE	25S318	25S434	25S638	25S800	25S958	25S1114
OVERALL RACK Height (cm)	14.3	18.4	22.5	26.7	30.8	34.9
NO. OF EXTENDER	1	2	3	4	5	6



16 Compartment

Maximum Glass Diameter: 11cm

Overall Rack Diameter: 50 x 50 cm

Individual Comp Diameter: 11.1 x 11.1 cm

MAX GLASS HEIGHT (CM)	9.2	13.3	17.4	21.5	25.7	29.8
PRODUCT CODE	9061701-xx	9061702-xx	9061703-xx	9061704-xx	9061705-xx	9061706-xx
CAMBRO CODE	16S318	16S434	16S638	16S800	16S958	16S1114
OVERALL RACK Height (cm)	14.3	18.4	22.5	26.7	30.8	34.9
NO. OF EXTENDER	1	2	3	4	5	6



*Available Color

Indent Colour



In Stock Colour



When ordering Base Rack add **CODE** suffix to item number
(example: 9060401-151 for Gray Colour)

Cambro Glass Rack

9 Compartment

Maximum Glass Diameter: 14.9 cm

Overall Rack Diameter: 50 x 50 cm

Individual Comp Diameter: 15.0 x 15.0 cm

MAX GLASS HEIGHT (CM)	9.2	13.3	17.4	21.5	25.7	29.8
PRODUCT CODE	9061801-xx	9061802-xx	9061803-xx	9061804-xx	9061805-xx	9061806-xx
CAMBRO CODE	9S318	9S434	9S638	9S800	9S958	9S1114
OVERALL RACK Height (cm)	14.3	18.4	22.5	26.7	30.8	34.9
NO. OF EXTENDER	1	2	3	4	5	6



*Available Color

Indent Colour



In Stock Colour



When ordering Base Rack add **CODE** suffix to item number
(example: 9060401-151 for Gray Colour)



16 Compartment (For Cups Only)

Overall Rack Diameter: 50 x 50 cm

Individual Comp Diameter: 10.95 x 11.1 cm

MAX CUP HEIGHT (CM)	6.6	10.7	14.9
PRODUCT CODE	9060901	9060902	9060903
CAMBRO CODE	16C258	16C414	16C578
OVERALL RACK Height (cm)	10.1	14.3	18.4
NO. OF EXTENDER	1	2	3



20 Compartment (For Cups Only)

Overall Rack Diameter: 50 x 50 cm

Individual Comp Diameter: 8.73 x 11.1 cm

MAX CUP HEIGHT (CM)	6.6	10.7	14.9
PRODUCT CODE	9061901	9061902	9061903
CAMBRO CODE	20C258	20C414	20C414+E3
OVERALL RACK Height (cm)	10.1	14.3	18.4
NO. OF EXTENDER	1	2	3

Open Base Rack Only

Rack Diameter (L x W x H): 50 x 50 x 10.1 cm

Inside Rack Height: 8.3 cm

PRODUCT CODE	9060401-XX
CAMBRO CODE	BR258

*Available Color

Indent Colour



In Stock Colour



When ordering Base Rack add **CODE** suffix to item number
(example: 9060401-151 for Gray Colour)



Cambro Glass Rack

5 x 9 Rack Base Plate & Tray

Rack Diameter (L x W x H): 50 x 50 x 10.1 cm
Inside Rack Height: 8.3 cm

PRODUCT CODE	9060301
CAMBRO CODE	PR59314



Rack Base Plate & Tray Open End

Rack Diameter (L x W x H): 50 x 50 x 10.1 cm
Inside Rack Height: 8.3 cm

PRODUCT CODE	9060201
CAMBRO CODE	OETR314

Rack Base Fork & Spoon

Rack Diameter (L x W x H): 50 x 50 x 10.1 cm
Inside Rack Height: 8.3 cm

PRODUCT CODE	9060101
CAMBRO CODE	FR258



Full Rack Cover

Rack Diameter (L x W x H): 50 x 50 x 2.4 cm

PRODUCT CODE	9060601
CAMBRO CODE	DRC2020

Half Size Rack Base Fork & Spoon

Rack Diameter (L x W x H): 50 x 50 x 10.1 cm
Inside Rack Height: 8.3 cm

PRODUCT CODE	9060102
CAMBRO CODE	HFR258



Half Size Open Rack Base

Rack Diameter (L x W x H): 50 x 50 x 10.1 cm
Inside Rack Height: 8.3 cm

PRODUCT CODE	9060402
CAMBRO CODE	HBR258

Cambro Glass Rack

Rack Extender Only



49 Compartment Full Drop Extender

Extender Diameter (L x W x H): 49.9 x 49.9 x 5.1 cm
 Comp Diameter (L x W x H): 6.2 x 6.2 x 4.1 cm

PRODUCT CODE	9061049
CAMBRO CODE	49E1



49 Compartment Half Drop Extender

Extender Diameter (L x W x H): 49.9 x 49.9 x 5.1 cm
 Comp Diameter (L x W x H): 6.2 x 6.2 x 4.1 cm

PRODUCT CODE	9061149
CAMBRO CODE	49E2



36 Compartment Full Drop Extender

Extender Diameter (L x W x H): 49.9 x 49.9 x 5.1 cm
 Comp Diameter (L x W x H): 7.3 x 7.3 x 4.1 cm

PRODUCT CODE	9061036
CAMBRO CODE	36E1



36 Compartment Half Drop Extender

Extender Diameter (L x W x H): 49.9 x 49.9 x 5.1 cm
 Comp Diameter (L x W x H): 7.3 x 7.3 x 4.1 cm

PRODUCT CODE	9061136
CAMBRO CODE	36E2



25 Compartment Full Drop Extender

Extender Diameter (L x W x H): 49.9 x 49.9 x 5.1 cm
 Comp Diameter (L x W x H): 8.9 x 8.9 x 4.1 cm

PRODUCT CODE	9061025
CAMBRO CODE	25E1



25 Compartment Half Drop Extender

Extender Diameter (L x W x H): 49.9 x 49.9 x 5.1 cm
 Comp Diameter (L x W x H): 8.9 x 8.9 x 4.1 cm

PRODUCT CODE	9061125
CAMBRO CODE	25E2



16 Compartment Full Drop Extender

Extender Diameter (L x W x H): 49.9 x 49.9 x 5.1 cm
 Comp Diameter (L x W x H): 11.1 x 11.1 x 4.1 cm

PRODUCT CODE	9061016
CAMBRO CODE	16E1



16 Compartment Half Drop Extender

Extender Diameter (L x W x H): 49.9 x 49.9 x 5.1 cm
 Comp Diameter (L x W x H): 11.1 x 11.1 x 4.1 cm

PRODUCT CODE	9061116
CAMBRO CODE	16E2

36 Comp Full Size Half Drop Extender

Extender Diameter (L x W x H): 49.9 x 49.9 x 5.1 cm
Comp Diameter (L x W x H): 7.3 x 7.3 x 4.1 cm

PRODUCT CODE	9061336
CAMBRO CODE	36E5



25 Comp Full Size Half Drop Extender

Extender Diameter (L x W x H): 49.9 x 49.9 x 5.1 cm
Comp Diameter (L x W x H): 8.9 x 8.9 x 4.1 cm

PRODUCT CODE	9061325
CAMBRO CODE	25E5

16 Comp Full Size Half Drop Extender

Extender Diameter (L x W x H): 49.9 x 49.9 x 5.1 cm
Comp Diameter (L x W x H): 11.1 x 11.1 x 4.1 cm

PRODUCT CODE	9061316
CAMBRO CODE	16E5

36 Comp Full Size Full Drop Extender

Extender Diameter (L x W x H): 49.9 x 49.9 x 5.1 cm
Comp Diameter (L x W x H): 7.3 x 7.3 x 4.1 cm

PRODUCT CODE	9061236
CAMBRO CODE	36E4



25 Comp Full Size Full Drop Extender

Extender Diameter (L x W x H): 49.9 x 49.9 x 5.1 cm
Comp Diameter (L x W x H): 8.9 x 8.9 x 4.1 cm

PRODUCT CODE	9061225
CAMBRO CODE	25E4

16 Comp Full Size Full Drop Extender

Extender Diameter (L x W x H): 49.9 x 49.9 x 5.1 cm
Comp Diameter (L x W x H): 11.1 x 11.1 x 4.1 cm

PRODUCT CODE	9061216
CAMBRO CODE	16E4

Full Size Open Extender

Extender Diameter (L x W x H): 49.9 x 49.9 x 5.1 cm
Comp Diameter (L x W x H): 45.7 x 45.7 x 4.1 cm

PRODUCT CODE	9061700
CAMBRO CODE	E3



Half Size Half Drop Extender

Extender Diameter (L x W x H): 50.2 x 25.2 x 5.1 cm
8 Comp Diameter (L x W x H): 10.5 x 11.3 x 4.1 cm

PRODUCT CODE	9061408
CAMBRO CODE	8HE2

Half Size Full Drop Extender

Extender Diameter (L x W x H): 50.2 x 25.2 x 5.1 cm
8 Comp Diameter (L x W x H): 10.5 x 11.3 x 4.1 cm

PRODUCT CODE	9061508
CAMBRO CODE	8HE1

10 Comp Diameter (L x W x H): 10.5 x 8.9 x 4.1 cm

PRODUCT CODE	9061410
CAMBRO CODE	10HE2

10 Comp Diameter (L x W x H): 10.5 x 8.9 x 4.1 cm

PRODUCT CODE	9061510
CAMBRO CODE	10HE1

17 Comp Diameter (L x W x H): 7.4 x 7.4 x 4.1 cm

PRODUCT CODE	9061417
CAMBRO CODE	17HE2

17 Comp Diameter (L x W x H): 7.4 x 7.4 x 4.1 cm

PRODUCT CODE	9061517
CAMBRO CODE	17HE1



Half Size Open Extender

Extender Diameter (L x W x H): 50.2 x 25.2 x 5.1 cm

Comp Diameter (L x W x H): 46.4 x 21.3 x 4.1 cm

PRODUCT CODE	9061600
CAMBRO CODE	HE3



Camdolly with Wheels & Handle

Base Diameter (L x W): 53 x 53 cm

Overall Diameter (L x W x H): 54.5 x 59.5 x 94 cm

Load Capacity (kg): 159

PRODUCT CODE	9060801
UNICA CODE	CDR2020H

Camdolly with Wheels Only

Base Diameter (L x W): 53 x 53 cm

Overall Diameter (L x W x H): 54.5 x 59.5 x 20.5 cm

Load Capacity (kg): 159

PRODUCT CODE	9060701
UNICA CODE	CDR2020





CLEANING & JANITORIAL WARE



Polyethylene Four Compartment Cutlery Box 四格餐具箱

CAMBRO

CODE	SIZE (l x w x h cm)
9035501	28.9 x 52 x 9.5



9035601



9035603



9035602

Polyethylene Cambox® Bus Boxes

CAMBRO

CODE	SIZE (l x w x h cm)
9035601	39.7 x 52.0 x 12.4
9035602	38.7 x 51.4 x 12.5
9035603	38.6 x 51.2 x 17.6

Polyethylene Cover For Cambox® 箱盖

CODE	SIZE (l x h cm)
9035701	39.4 x 52



Deep Plastic Bus Box / Container 工业箱



CODE	SIZE (l x h cm)
9035801	52.0 x 39.0 x 17.7
9035802	52.0 x 39.0 x 12.7



8-Compartment Half Flatware Basket 8 格半号平餐具

CAMBRO

CODE	SIZE (h cm)
9060508	18.4



8-Comp Flatware Basket 8 格平餐具



CODE	REMARK
9036001	Without Handle
9036101	With Handle



4 Compartment Cutlery Tray 四格筷子盒



CODE	SIZE (l x h cm)
9035901	50 x 32.5



UNICA WAREWASHING HANDLING SYSTEM

Molded in one-piece with double-wall construction from PP Polymer, the **UNICA** Washracks are resistant to heat and chemicals. They are available in the standard size of 500mm x 500mm. Base racks have comfortable handgrips on all four sides facilitating handling. For added height and protection, use our **UNICA** “clip-on” extenders. With the **UNICA** Warewashing- Handling System, you can create the system most suitable to your needs

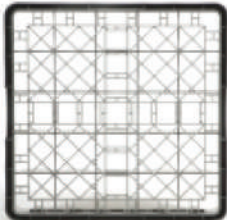
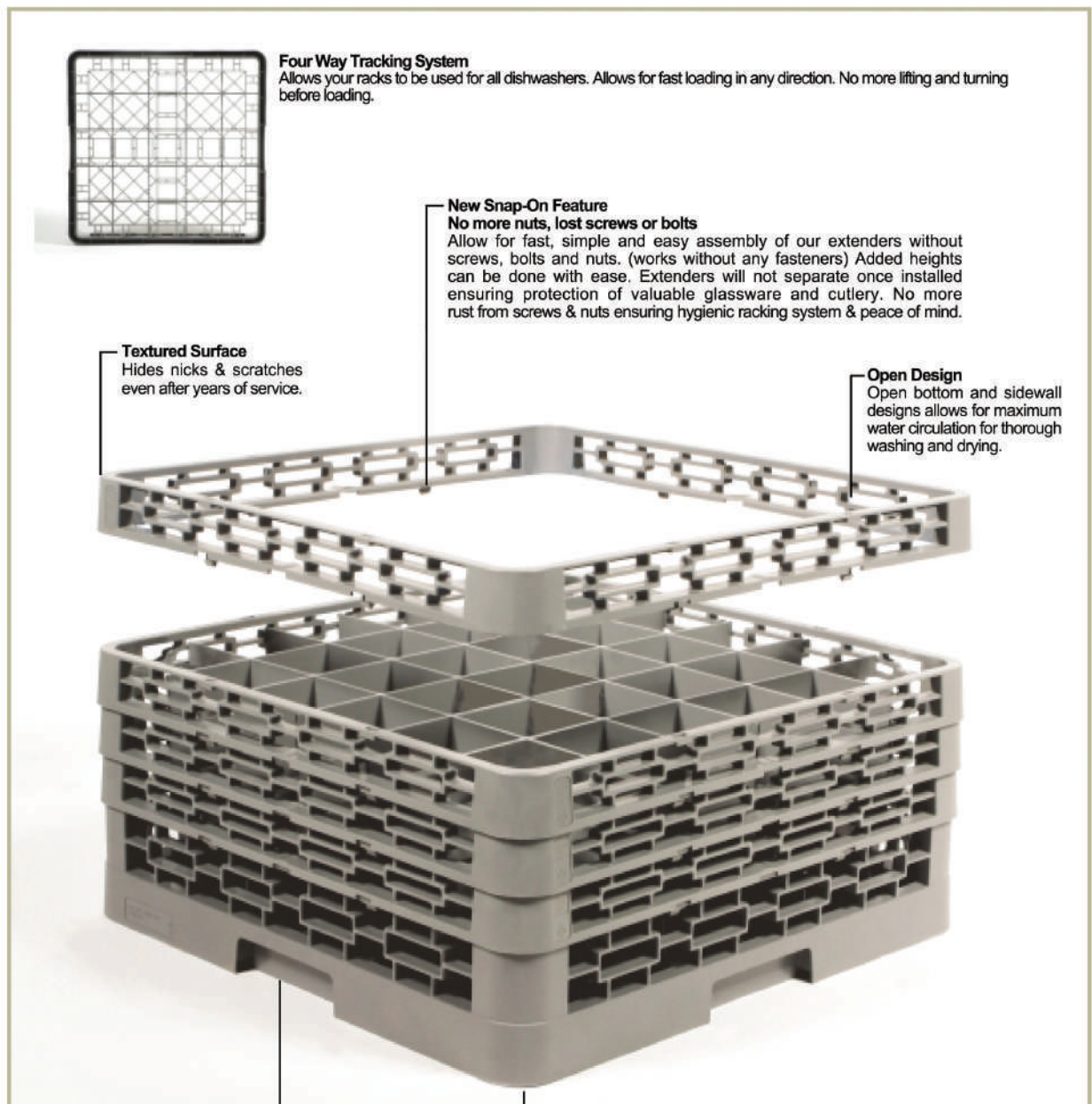

Four Way Tracking System
Allows your racks to be used for all dishwashers. Allows for fast loading in any direction. No more lifting and turning before loading.

New Snap-On Feature
No more nuts, lost screws or bolts
Allow for fast, simple and easy assembly of our extenders without screws, bolts and nuts. (works without any fasteners) Added heights can be done with ease. Extenders will not separate once installed ensuring protection of valuable glassware and cutlery. No more rust from screws & nuts ensuring hygienic racking system & peace of mind.

Textured Surface
Hides nicks & scratches even after years of service.

Open Design
Open bottom and sidewall designs allows for maximum water circulation for thorough washing and drying.

Hand Grips
Comfortable handgrips on all four sides

Molded in one piece with double wall construction providing extra strength & durability.
Our racks are chemical and heat resistant to withstand heat and impact to provide years of service.

Unica Glass Rack

49 Compartment

Glass Diameter: 2.5 - 6.25 cm

Overall Rack Diameter: 50 x 50 cm

Individual Comp Diameter: 6.4 x 6.4 cm



MAX GLASS HEIGHT (CM)	7.3	11.3	15.3	19.3	23.3	27.3	31.3	35.3
PRODUCT CODE	9050149	9051401	9051402	9051403	9051404	9051405	9051406	9051407
UNICA CODE	RBC49	RBC49/1	RBC49/2	RBC49/3	RBC49/4	RBC49/5	RBC49/6	RBC49/7
OVERALL RACK Height (cm)	10	14	18	22	26	30	34	38
INDIVIDUAL COMP Height (cm)	8.8	12.8	16.8	20.8	24.8	28.8	32.8	36.8
NO. OF EXTENDER	0	1	2	3	4	5	6	7

36 Compartment

Glass Diameter: 6.25 - 7.3 cm

Overall Rack Diameter: 50 x 50 cm

Individual Comp Diameter: 7.4 x 7.4 cm



MAX GLASS HEIGHT (CM)	7.3	11.3	15.3	19.3	23.3	27.3	31.3	35.3
PRODUCT CODE	9050136	9051501	9051502	9051503	9051504	9051505	9051506	9051507
UNICA CODE	RBC36	RBC36/1	RBC36/2	RBC36/3	RBC36/4	RBC36/5	RBC36/6	RBC36/7
OVERALL RACK Height (cm)	10	14	18	22	26	30	34	38
INDIVIDUAL COMP Height (cm)	8.8	12.8	16.8	20.8	24.8	28.8	32.8	36.8
NO. OF EXTENDER	0	1	2	3	4	5	6	7

25 Compartment

Glass Diameter: 7.3 - 8.9 cm

Overall Rack Diameter: 50 x 50 cm

Individual Comp Diameter: 9.0 x 9.0 cm



MAX GLASS HEIGHT (CM)	7.3	11.3	15.3	19.3	23.3	27.3	31.3	35.3
PRODUCT CODE	9050125	9051601	9051602	9051603	9051604	9051605	9051606	9051607
UNICA CODE	RBC25	RBC25/1	RBC25/2	RBC25/3	RBC25/4	RBC25/5	RBC25/6	RBC25/7
OVERALL RACK Height (cm)	10	14	18	22	26	30	34	38
INDIVIDUAL COMP Height (cm)	8.8	12.8	16.8	20.8	24.8	28.8	32.8	36.8
NO. OF EXTENDER	0	1	2	3	4	5	6	7



Unica Glass Rack

20 Compartment (For Coffee Cup)

Glass Diameter: 7.3 - 9.0 cm

Overall Rack Diameter: 50 x 50 cm

Individual Comp Diameter: 9.1 x 11.3 cm



MAX GLASS HEIGHT (CM)	7.3	11.3	15.3	19.3	23.3	27.3	31.3	35.3
PRODUCT CODE	9050120	9051701	9051702	9051703	9051704	9051705	9051706	9051707
UNICA CODE	RBC20	RBC20/1	RBC20/2	RBC20/3	RBC20/4	RBC20/5	RBC20/6	RBC20/7
OVERALL RACK Height (cm)	10	14	18	22	26	30	34	38
INDIVIDUAL COMP Height (cm)	8.8	12.8	16.8	20.8	24.8	28.8	32.8	36.8
NO. OF EXTENDER	0	1	2	3	4	5	6	7

16 Compartment

Glass Diameter: 8.9 - 11.25 cm

Overall Rack Diameter: 50 x 50 cm

Individual Comp Diameter: 11.3 x 11.3 cm



MAX GLASS HEIGHT (CM)	7.3	11.3	15.3	19.3	23.3	27.3	31.3	35.3
PRODUCT CODE	9050116	9051801	9051802	9051803	9051804	9051805	9051806	9051807
UNICA CODE	RBC16	RBC16/1	RBC16/2	RBC16/3	RBC16/4	RBC16/5	RBC16/6	RBC16/7
OVERALL RACK Height (cm)	10	14	18	22	26	30	34	38
INDIVIDUAL COMP Height (cm)	8.8	12.8	16.8	20.8	24.8	28.8	32.8	36.8
NO. OF EXTENDER	0	1	2	3	4	5	6	7

9 Compartment

Glass Diameter: 11.25 - 15.0 cm

Overall Rack Diameter: 50 x 50 cm

Individual Comp Diameter: 15.1 x 15.1 cm



MAX GLASS HEIGHT (CM)	7.3	11.3	15.3	19.3	23.3	27.3	31.3	35.3
PRODUCT CODE	9050109	9051901	9051902	9051903	9051904	9051905	9051906	9051907
UNICA CODE	RBC9	RBC9/1	RBC9/2	RBC9/3	RBC9/4	RBC9/5	RBC9/6	RBC9/7
OVERALL RACK Height (cm)	10	14	18	22	26	30	34	38
INDIVIDUAL COMP Height (cm)	8.8	12.8	16.8	20.8	24.8	28.8	32.8	36.8
NO. OF EXTENDER	0	1	2	3	4	5	6	7

Unica Glass Rack

Rack Base Open Tray

Rack Diameter (L x W x H): 50 x 50 x 10 cm

PRODUCT CODE	9050801
UNICA CODE	RBT



Rack Base Fork & Spoon

Rack Diameter (L x W x H): 50 x 50 x 10 cm

PRODUCT CODE	9050501
UNICA CODE	RBFS



Rack Base Plate & Tray

Rack Diameter (L x W x H): 50 x 50 x 10 cm

PRODUCT CODE	9050601
UNICA CODE	RBPT



Rack Base Plate & Tray Open End

Rack Diameter (L x W x H): 50 x 50 x 10 cm

PRODUCT CODE	9050701
UNICA CODE	RBPTO



Rack Clip Tag

Diameter (L x W): 8 x 4 cm

PRODUCT CODE	9051001-XX
UNICA CODE	RCT-XX

*Available Color

 RD  BL  WH  GR  YE

When ordering Rack Clip in Red add **CODE** suffix to item number (example: 9051001-RD)

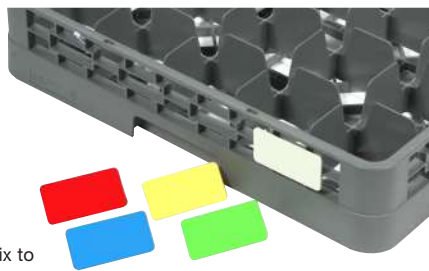

Wash Rack Cover

Diameter (L x W x H): 50.5 x 50.5 x 2.5 cm

PRODUCT CODE	9050901
UNICA CODE	RCOVER



Rack Cutlery Holder

Diameter (L x W x H): 10.8 x 10.8 x 13.8 cm

PRODUCT CODE	9051101
UNICA CODE	RCH



*Fits 16 cutlery holder per open rack



Unica Glass Rack

Rack Base Only



49 Compartment

Glass Diameter: 2.5 - 6.25 cm

Overall Rack Diameter: 50 x 50 cm

Individual Comp Diameter: 6.4 x 6.4 cm

MAX GLASS HEIGHT (CM)	7.3
PRODUCT CODE	9050149
UNICA CODE	RBC49
OVERALL RACK Height (cm)	10
INDIVIDUAL COMP Height (cm)	8.8



36 Compartment

Glass Diameter: 6.25 - 7.3 cm

Overall Rack Diameter: 50 x 50 cm

Individual Comp Diameter: 7.4 x 7.4 cm

MAX GLASS HEIGHT (CM)	7.3
PRODUCT CODE	9050136
UNICA CODE	RBC36
OVERALL RACK Height (cm)	10
INDIVIDUAL COMP Height (cm)	8.8

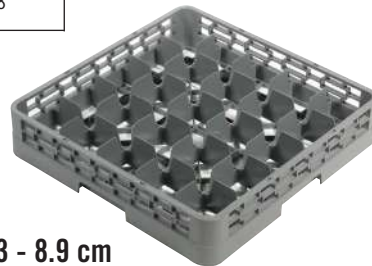

25 Compartment

Glass Diameter: 7.3 - 8.9 cm

Overall Rack Diameter: 50 x 50 cm

Individual Comp Diameter: 9.0 x 9.0 cm

MAX GLASS HEIGHT (CM)	7.3
PRODUCT CODE	9050125
UNICA CODE	RBC25
OVERALL RACK Height (cm)	10
INDIVIDUAL COMP Height (cm)	8.8



20 Compartment (For Coffee Cup)

Glass Diameter: 7.3 - 9.0 cm

Overall Rack Diameter: 50 x 50 cm

Individual Comp Diameter: 9.1 x 11.3 cm

MAX GLASS HEIGHT (CM)	7.3
PRODUCT CODE	9050120
UNICA CODE	RBC20
OVERALL RACK Height (cm)	10
INDIVIDUAL COMP Height (cm)	8.8



16 Compartment

Glass Diameter: 8.9 - 11.25 cm

Overall Rack Diameter: 50 x 50 cm

Individual Comp Diameter: 11.3 x 11.3 cm

MAX GLASS HEIGHT (CM)	7.3
PRODUCT CODE	9050116
UNICA CODE	RBC16
OVERALL RACK Height (cm)	10
INDIVIDUAL COMP Height (cm)	8.8



9 Compartment

Glass Diameter: 11.25 - 15.0 cm

Overall Rack Diameter: 50 x 50 cm

Individual Comp Diameter: 15.1 x 15.1 cm

MAX GLASS HEIGHT (CM)	7.3
PRODUCT CODE	9050109
UNICA CODE	RBC9
OVERALL RACK Height (cm)	10
INDIVIDUAL COMP Height (cm)	8.8

Unica Glass Rack

Rack Extender Only



49 Compartment Extender

Extender Diameter (L x W x H): 50 x 50 x 5.1 cm
Comp Diameter (L x W x H): 6.4 x 6.4 x 4.0 cm

PRODUCT CODE	9050249
UNICA CODE	REC49



36 Compartment Extender

Extender Diameter (L x W x H): 50 x 50 x 5.1 cm
Comp Diameter (L x W x H): 7.4 x 7.4 x 4.0 cm

PRODUCT CODE	9050236
UNICA CODE	REC36



25 Compartment Extender

Extender Diameter (L x W x H): 50 x 50 x 5.1 cm
Comp Diameter (L x W x H): 9.0 x 9.0 x 4.0 cm

PRODUCT CODE	9050225
UNICA CODE	REC25



20 Compartment Extender

Extender Diameter (L x W x H): 50 x 50 x 5.1 cm
Comp Diameter (L x W x H): 9.1 x 11.3 x 4.0 cm

PRODUCT CODE	9050220
UNICA CODE	REC20



16 Compartment Extender

Extender Diameter (L x W x H): 50 x 50 x 5.1 cm
Comp Diameter (L x W x H): 11.3 x 11.3 x 4.0 cm

PRODUCT CODE	9050216
UNICA CODE	REC16



9 Compartment Extender

Extender Diameter (L x W x H): 50 x 50 x 5.1 cm
Comp Diameter (L x W x H): 15.1 x 15.1 x 4.0 cm

PRODUCT CODE	9050209
UNICA CODE	REC9

Open Extender

Extender Diameter (L x W x H): 50 x 50 x 5.1 cm

PRODUCT CODE	9050401
UNICA CODE	REO





Unica Glass Rack

Rack Compartment With Tilt Rib



16 Compartment

Glass Diameter: 8.9 - 11.25 cm

Overall Rack Diameter: 50 x 50 cm

Individual Comp Diameter: 11.3 x 11.3 cm

MAX GLASS HEIGHT (CM)	7.3
PRODUCT CODE	9050316
UNICA CODE	RBC16TR
OVERALL RACK Height (cm)	10
INDIVIDUAL COMP Height (cm)	8.8



25 Compartment

Glass Diameter: 7.3 - 8.9 cm

Overall Rack Diameter: 50 x 50 cm

Individual Comp Diameter: 9.0 x 9.0 cm

MAX GLASS HEIGHT (CM)	7.3
PRODUCT CODE	9050325
UNICA CODE	RBC25TR
OVERALL RACK Height (cm)	10
INDIVIDUAL COMP Height (cm)	8.8



20 Compartment

Glass Diameter: 7.3 - 9.0 cm

Overall Rack Diameter: 50 x 50 cm

Individual Comp Diameter: 9.1 x 11.3 cm

MAX GLASS HEIGHT (CM)	7.3
PRODUCT CODE	9050320
UNICA CODE	RBC20TR
OVERALL RACK Height (cm)	10
INDIVIDUAL COMP Height (cm)	8.8

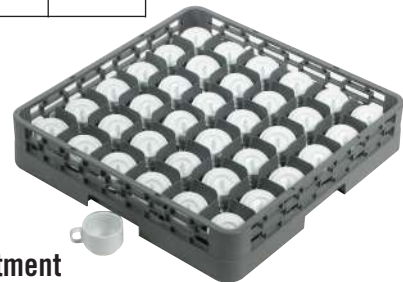

36 Compartment

Glass Diameter: 6.25 - 7.3 cm

Overall Rack Diameter: 50 x 50 cm

Individual Comp Diameter: 7.4 x 7.4 cm

MAX GLASS HEIGHT (CM)	7.3
PRODUCT CODE	9050336
UNICA CODE	RBC36TR
OVERALL RACK Height (cm)	10
INDIVIDUAL COMP Height (cm)	8.8

Rack Dolly with Wheels & Handle

Base Diameter (L x W x H): 54 x 54 x 5.0 cm

Handle Diameter (W x H): 51 x 76 cm

PRODUCT CODE	9051201
UNICA CODE	RDOLLY1

Rack Dolly with Wheels Only

Base Diameter (L x W x H): 54 x 54 x 5.0 cm

PRODUCT CODE	9051301
UNICA CODE	RDOLLY2

3M Scotch-Brite Cleaning Pad



4004CC Easy Erasing Pad
易擦除垫

CODE	SIZE (l x w x h cm)	PACKAGING
9080101	7 x 11.43 x 3	4 Pads / Bag, 3 Bags / Case

Soft, flexible pad cleans many surfaces and is safe for indirect food contact areas. Innovative white polymeric foam erases hard-to-clean stains, marks and scuffs. Unique blue urethane layer provides durability and keeps hands away from messes. Easy-to-use! Simply wet pad and squeeze out excess water. Use white side of pad to erase marks. Use blue side to wipe away residue.



9030 Light Scrubbing Pad
白丝布

CODE	SIZE (l x h cm)	PACKAGING
9080201	8.89 x 12.7	40 Pads / Case

Convenient, thick, hand-sized pad designed for gentle, no-scratch cleaning of the most delicate surfaces. Typical applications: glass, plastic, fine china, porcelain, ceramic, non-stick surfaces and glass cookware



96 General Purpose Green Pad
青布

CODE	SIZE (l x h cm)	PACKAGING
9080301	15.24 x 22.86	20 Pads / Box, 3 Boxes / Case

Synthetic scouring pad is excellent for common cleaning jobs. Performs well on kitchen equipment, walls, railings, floors, desks, stairways, counters and maintenance equipment



9650 Green Scrubbing Pad
青布

CODE	SIZE (l x h cm)	PACKAGING
9080401	8.89 x 12.7	40 Pads / Box, 2 Boxes / Case

Thick, medium-duty pad for everyday general-purpose cleaning jobs. Convenient, hand-size eliminates the need to cut or fold pad.



86 Heavy Duty Scouring Pad
青布

CODE	SIZE (l x h cm)	PACKAGING
9080501	15.24 x 22.86	12 Pads / Box, 3 Boxes / Case

Open construction pad with tough fibers and abrasives make fast work of heavy duty cleaning jobs. Use in the kitchen to replace scrapers, steel wool and metal sponges. Typical applications include heavily baked-on food and food processing equipment.



88 Extra Heavy Duty Scrubbing Pad
青布

CODE	SIZE (l x h cm)	PACKAGING
9080601	8.89 x 12.7	40 Pads / Case

Thick, open mesh construction. Rinses out easily, doesn't splinter and won't rust. Can replace stainless steel scrubbers. More effective than most pot scrubbing pads. Ideal for cleaning stubborn cheeses and thick sauce deposits.

3000 Power Sponge
海棉

CODE	SIZE (l x w x h cm)	PACKAGING
9080701	11.4 x 7.1 x 1.5	20 Sponges / Case

Two cleaning tools in one - a Scotch-Brite™ Power Pad combined with a sponge. Up to eight times less abrasive than other medium duty/heavy duty commercial scouring products to help reduce scratching.

Features 3M's anti-microbial technology integrated into every fiber. Sponge resists growth of odor-causing bacteria through hundreds of uses.





2000 Power Pad 湾深蓝丝布

CODE	SIZE (l x h cm)	PACKAGING
9080801	13.97 x 9.9	20 Pads / Case

Scours up to four times faster than conventional scouring products. Scouring power for the toughest cleaning jobs, yet gentle enough to use on most surfaces. Safe on stainless steel; scratches up to eight times less than other medium/heavy-duty commercial scouring products.



C41 Commercial Washing Sponge 海绵

CODE	SIZE (l x w x h cm)	PACKAGING
9081001	19.8 x 10.6 x 3.8	24 Sponges / Case

These cellulose sponges are 10 times more absorbent than polyurethane sponges.* Stronger, less likely to fall apart. A size for every clean-up need



213 Double Sided Sponge 海绵

CODE	SIZE (l x w cm)	PACKAGING
9081201	10 x 7	3 Pcs / Pack, 36 Pack / Carton

Scotch-Brite® Heavy Duty Scrub Sponge for tough to clean burnt-on messes. From grunge on the grill, to pots and pans that sat overnight, get it done right!



5001 Light Duty Scrubbing Sponge 海绵

CODE	SIZE (l x w cm)	PACKAGING
9081401	13.5 x 7	3 Pads / Pack, 20 Pack / Carton

Ideal for delicate glass wear or porcelain, this low-scratch scrubbing sponge is designed for gentle cleaning. The urethane sponge helps to carry cleaning solution and acts as a holder for good grip.



74 Medium Duty Scrubbing Sponge 海绵

CODE	SIZE (l x w x h cm)	PACKAGING
9080901	15.49 x 9 x 1.77	20 Sponges / Case

Dual-action cleaning tool. On one side, it's a No. 96 scouring pad for scrubbing and cleaning. On the other side, the cellulose sponge quickly wipes up spills and messes and can carry cleaning solutions to the work surface.



2020 Purple Scouring Pad 紫色冲刷垫

CODE	SIZE (l x w cm)	PACKAGING
9081101	11.4 x 7	24 / Case

Cleans your dirtiest pots and pans twice as fast as conventional heavy-duty scouring - with less scratching. Food debris rinses out of the pad easily. Unique web construction stands up to your toughest jobs. Scratches less than other heavy duty pads.



9489 Soft Scour Sponge 海绵

CODE	SIZE (l x w x h cm)	PACKAGING
9081501	13.4 x 8 x 1.5	2 Pieces / Packet

This sponge combines no-scratch scrubbing and moisture pick-up all in one! One side scours and the other side wipes up spills or carries cleaning solution to the work surface. Typical applications include tubs, sinks,



7443 Double Sided Sponge 海绵

CODE	SIZE (l x w cm)	PACKAGING
9081601	10 x 7	6 Pcs / Pack, 55 Pack / Carton



3-Pcs Pack Double Side Sponge
海棉

CODE	PACKAGING
------	-----------

9081801 100 Packets / Carton



"ECONOMY" Double Sided Washing Sponge
普通海棉

CODE

9081901



Bright Star Sponge with Silver Lining
包银丝线海棉

CODE	PACKAGING
------	-----------

9082001 300 Packets / Carton



Green Scouring Pad
青布

CODE

9082101



Green Pad
青色布

CODE	PACKAGING
------	-----------

9082201 4 piece pack



Stainless Steel Scouring Ball
钢丝球

CODE	SPEC (G)	PACKAGING
------	----------	-----------

9082335 35 300 Pieces / Carton
9082350 50 240 Pieces / Carton

Microfibre Cloth
超细纤维布

CODE	SIZE (l x w x h cm)	Remark
9191301-xx	40 x 38	5 Pcs / Packet

*Available Colour

■ BL ■ BR ■ PK ■ RD ■ WH ■ AST (assorted of 5)

When ordering Blue Colour add **CODE** suffix to item number (example: 9191301-BL)





High Performance Microfibre Cloth 丝布

CODE	SIZE (l x h cm)	PACKAGING
9090601-xx	36 x 36	10 Pieces / Packet

The 3M Scotch-Brite High Performance Cloth 2011 is an efficient cleaning tool consisting of microfibers in a unique knit pattern. The Scotch-Brite High Performance Cloth may be used dry or damp, with or without cleaning chemicals.

*Available Colour

■ BL
 ■ GR
 ■ GY
 ■ RD
 ■ YE

When ordering Blue Colour add **CODE** suffix to item number (example: 9090601-BL)



Rectangular White Bath Towel 白毛巾

CODE	SIZE (l x h cm)
5140401	68.5 x 137

Rectangular Cotton Glass Cloth 方形全棉抹玻璃布

CODE	SIZE (l x h cm)	PACKAGING
9090801-xx	20 x 30	1 Dozen / Pack

*Available Colour

■ BL
 ■ GR
 ■ RD

When ordering Blue Colour add **CODE** suffix to item number (example: 9090801-BL)



Rectangular Checked Kitchen Towel / Cloth 长抹玻璃杯布

CODE	SIZE (l x h cm)
9090701-xx	45.7 x 71

*Available Colour

■ BL
 ■ GR
 ■ BR
 ■ RD
 ■ YE

When ordering Blue Colour add **CODE** suffix to item number (example: 9090701-BL)



Thick Good Morning Towel (12'S) “祝君早安”毛巾 (12件 / 厚)

CODE
5140100



CLEANING & JANITORIAL WARE



Pressure Water Spray 气压式喷雾器

CODE	SPEC
	(L)
9091115	1.5
9091120	2.0



Water Spray 喷雾器

CODE	SIZE
	(w x d x h cm)
9091201	12.5 x 8.5 x 34

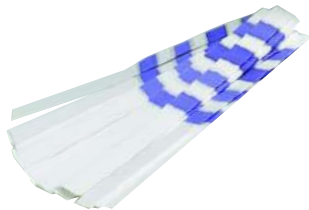

Shortening Monitor 油品质量试纸



CODE	PACKAGING
9090901	40 Pieces / Bottle, 4 Bottles / Carton
9091001	40 Pieces / Bottle, 4 Bottles / Carton (Low Range)

Shortening Monitor:

Easy to use, easy to read and eliminates guesswork. Helps keep fried food quality high. Helps save money by preventing the premature disposal of shortening. Works equally well in animal, vegetable or A/V blend shortenings.

Low Range Shortening Monitor:

When a more precise reading of early degradation of oil is desired, try the 3M™ Low Range Oil Quality Test Strips. This strip measures free fatty acid concentrations at 1%, 1.5%, 2% and 2.5%. Ideal for food processing applications or to help meet regulatory requirements.



Stainless Steel Polish & Cleaner 不锈钢抛光和清洁剂



CODE	PACKAGING	CAP
		(OZ.)
9100301	12 Cans / Case	21

Sprayable liquid cleans and polishes stainless steel, chrome, aluminum and laminated plastic surfaces to a high gloss in one step.



Grill Cleaner Screen
烧烤架清洗垫

CODE	PACKAGING	SIZE (l x h cm)
9090201	8'S/packet	11.4 x 14



Grill Screen Holder
烧烤清洗垫架

CODE	SIZE (l x h cm)
9090301	12.7 x 7.6



Broiler / Grill Brush with Red Handle
烧烤架刷

CODE	SIZE (cm)
9090401	26.7



Wire Tap Brush with Scraper
刷

CODE	SIZE (cm)
9090501	35.5



Broiler Brush w/Carbon Steel Bristles
烧烤刷

CODE	BRUSH SIZE (l x w x h cm)	Handle Length
9152201	21.6 x 12.7 x 3.1	77cm

- Wire brushes and Stainless Steel metal Scrapers make quick and easy removal of heavy Carbon deposits, rust, and burned-on food build up
- Broiler Master features a specially treated wooden head with two-sided Stainless or Carbon Steel bristles, a metal end Scraper, and a 30" wood handle



Oven Brush & Scraper w/Brass Bristles
烧烤刷

CODE	BRUSH SIZE (l x w x h cm)	Handle Length
9152301	21.6 x 10.8 x 3.8	107cm

Oven Brush features crimped Brass wire bristles and a full length Stainless Steel Scraper for cleaning high-temperature stack ovens



Redco® Grill Tender® Scraper
烧烤刷

CODE	SCRAPER SIZE (l x w cm)	Handle Length
9152001	15.2 x 7.9	54.9 cm



Replacement Blade for Redco Grill Scraper
烧烤刷刀

CODE	BLADE LENGTH (l cm)
9152002	15.2

Quickly and easily remove carbonized food from your grill surface with the Redco® Grill Tender®. Equipped with a splashguard and an extra-long handle that is positioned above the grill, the Redco® Grill Tender® scraper offers added protection from burns.

CLEANING & JANITORIAL WARE

Versatile chemical protection that performs across a diverse range of applications

DESCRIPTION

- High performance nitrile compound provides an outstanding combination of chemical resistance and strength
- Offers superior snag, puncture and abrasion protection over rubber or neoprene gloves
- Suitable for heavy-duty cleaning applications
- High levels of flexibility, comfort and dexterity
- Won't swell, weaken or degrade, and does not promote contact dermatitis
- All Sol-Vex® gloves comply with FDA food handling requirements (21 CFR 177.2600)

Ideal Applications

- Chemical plants and transportation
- Chemical processing, oil refining and petrochemicals
- Cleaning and de-greasing
- Exposure to chemicals, solvents, hazardous liquids, PVC cements or standing water
- Janitorial and maintenance work



13" Solvex Nitrile Glove

橡胶洗碗手套

CODE	SIZE	SPEC
9110608	8	Thickness 15 mil,
9110609	9	flock lined material



13" Extra Duty Rubber Glove

橡胶洗碗手套

CODE	SIZE	SPEC
9110801	Medium	Thickness 0.75 mm,
9110802	Large	cotton flocking material
9110803	X-Large	



Black Rubber Glove, Economy

黑色橡胶洗碗手套

CODE	SIZE	SPEC
9111001	Small	
9111002	Medium	
9111003	Large	
9111004	X-Large	

15" Solvex Nitrile Glove

橡胶洗碗手套

CODE	SIZE	SPEC
9110708	8	Thickness 22 mil,
9110709	9	unlined material



Description

- 50% thicker than standard flocklined gloves.
- Extremely high resistance to many ketones, salts, detergents, alcohols, alkalis and fats.
- 100% natural rubber with no fillers. Excellent resistance to mechanical hazards plus increased chemical protection.
- Chlorinated. For better grip and increased chemical resistance.
- 100% cotton flocklining. Makes a heavy glove softer and more comfortable to wear. Helps absorb perspiration.

Ideal Applications

- Heavy duty handling: where sensitivity is also required
- Chemical processing and preparation
- Maintenance of plant and heavy equipment



15" Pink Rubber Glove

橡胶洗碗手套

CODE	SIZE	PACKAGING
9110901	Small	100 Pair / Carton
9110902	Medium	100 Pair / Carton
9110903	Large	100 Pair / Carton
9110904	X-Large	100 Pair / Carton



Vinyl Surgical Hand Glove (Powdered)
橡胶手术手套 (Powdered)

CODE	SIZE	PACKAGING
9111301	Small	10 Box / Carton, 100 Pairs / Box
9111302	Medium	10 Box / Carton, 100 Pairs / Box
9111303	Large	10 Box / Carton, 100 Pairs / Box



Blue Nitrile Exam Hand Glove
橡胶手术手套

CODE	SIZE	PACKAGING
9111901	Small	10 Box / Carton, 100 Pairs / Box
9111902	Medium	10 Box / Carton, 100 Pairs / Box
9111903	Large	10 Box / Carton, 100 Pairs / Box



Clear Plastic Face Mask
面罩

CODE	PACKAGING
9111803	10 Pcs / Box



Disposable Apron
一次性围裙

CODE	PACKAGING
9111501	100 Pieces / Packet , 10 Packets / Carton



Latex Surgical Hand Glove
橡胶手术手套

CODE	SIZE	PACKAGING
9111401	Small	10 Box / Carton, 100 Pairs / Box
9111402	Medium	10 Box / Carton, 100 Pairs / Box
9111403	Large	10 Box / Carton, 100 Pairs / Box



1-Ply Paper Face Mask
一次性口罩

CODE	PACKAGING
9111801	100 Packets / Carton



Full Size Thick PVC Apron with Velcro
全身厚胶宽带围裙

CODE

9111601-xx

*Available Colour

BL BK GR YL WH BG

When ordering Blue Apron add **CODE** suffix to item number (example: 9111601-BL)

"X-LONG" 1/1 Size Thick PVC Apron
(加长) 全身厚胶围裙

CODE

9111701

Safety Shoe with Lace

安全鞋

Sole Construction

1. Single density light-weight and slip resistant polyurethane (PU) sole (SRC Outsole)
2. Sole resistant to oils and acids/alkalis
3. Antistatic

Upper Construction

1. Printed Leather
2. Breathable non-woven fabric lining
3. Antistatic insole board
4. Extra Wide 5-toe toecap provides maximum comfort for your toes
5. 200 Joules steel toe cap for impact and compression resistance
6. Pierce resistant 1100N steel mid-sole insert
7. Extra thick full length fabric-lined EVA foam insole with shock absorption, anti-bacterial and anti-static properties. It also provides extra comfort for long hours of usage.



KWS800

CODE	SIZE	CODE	SIZE
9120103	3	9120108	8
9120104	4	9120109	9
9120105	5	9120110	10
9120106	6	9120111	11
9120107	7	9120112	12



KWS803 High Density

CODE	SIZE	CODE	SIZE
9120205	5	9120209	9
9120206	6	9120210	10
9120207	7	2190211	11
9120208	8	9120212	12

Safety Shoe with Lace

安全鞋

- 4" low cut lace up
- Upper made with Buffalo full grain leather (for K800 & K807)
- Upper made with Exclusive Japan microfiber leather, excellent breathability and chemical resistance material (for K807W)
- Composite Wide safety toe-cap meeting EN ISO 20345 200 Joules impact
- Non-metallic anti-perforation sole plate meeting EN ISO 20345 1100N
- Full cambrelle lining
- Dual density PU/PU outsole mid sole design for comfort outsole designed for Ultimate abrasion performance
- Thick Full EVA breathable foot bed with textile lining comfort heel cushion, arch stability with air channel system



K800

CODE	SIZE	CODE	SIZE
9120304	4	9120309	9
9120305	5	9120310	10
9120306	6	9120311	11
9120307	7	9120312	12
9120308	8		



K807

CODE	SIZE	CODE	SIZE
9120404	4	9120409	9
9120405	5	9120410	10
9120406	6	9120411	11
9120407	7	9120412	12
9120408	8		



K807W

CODE	SIZE	CODE	SIZE
9120504	4	9120509	9
9120505	5	9120510	10
9120506	6	9120511	11
9120507	7	9120512	12
9120508	8		

Rubber Water Boots

安全鞋



Rubber Water Boots without Front Metal Capping

胶水鞋

CODE	SIZE	CODE	SIZE
BLACK BOOTS		WHITE BOOTS	
9120605	38	9120806	39
9120606	39	9120807	40
9120607	40	9120808	41
9120608	41	9120809	42
9120609	42	9120810	43
9120610	43	9120811	44
		9120812	45

Low Angle Rubber Water Boots

胶水鞋

CODE	SIZE	CODE	SIZE
9120703	36	9120707	40
9120704	37	9120708	41
9120705	38	9120709	42
9120706	39	9120710	43



CLEANING & JANITORIAL WARE

Woven Tailbands:

- hold yarn in place for greater floor coverage and improved launderability

Looped ends:

- reduce fraying and de-plying for better durability and longer product life



400gm Cotton Mop Head

棉拖把布

CODE	SPEC
	(g)
9130101-xx	400

*Available Colour

■ BK ■ GR ■ RD WH

When ordering Blue Colour Mop Head add **CODE** suffix to item number (example: 9130101-BL)



With Rubber Grip End

Aluminium Mop Handle with Plastic Clip

铝制地拖手柄

CODE	SIZE
	(cm)
9130201-xx	150

*Available Colour

■ BL ■ RD ■ YL

When ordering Blue Colour Mop Handle add **CODE** suffix to item number (example: 9130201-BL)



Economy Cotton Mop Head

胶拖布头

CODE	SIZE
9130530	30oz
9130540	40oz



Economy Wooden Mop Turning Handle

旋转头木柄

CODE	SIZE
	(cm)
9130601	110



Economy Aluminium Mop Turning Handle

旋转头铝柄

CODE	SIZE
	(cm)
9130701	120

Kut-A-Way® Dust Mops / Snap On Wire Frames & Handles



Cut-end mop for general purpose dust mopping.

- Pre-laundered and pre-shrunk.
- Launderable for long product life.
- Envelope backing style.



CODE	MOP SIZE		COLOUR	REMARK
	(l x w cm)	Inch		
9130901	45.7 x 12.7	18" x 5"	White	K152
9130902	61 x 12.7	24" x 5"	White	K153
9130903	91.4 x 12.7	36" x 5"	White	K155

Snap On Wire Frames

- Corrosion resistant, powder coated, heavy-duty metal frame for durable performance.



CODE	FRAME SIZE		Remark
	(l x w cm)	Inch	
9131001	45.7 x 12.7	18" x 5"	M252
9131002	61 x 12.7	24" x 5"	M253
9131003	91.4 x 12.7	36" x 5"	M255

Snap On Handle for Dust Mop Frames

- Available in easily sanitized, vinyl-covered wood, fiberglass or hardwood handles.
- Attach to the Snap-On Dust Mop Frame.
- Sliding collar locks the handle into position or allows for a full 360 degree swivel action.

CODE	HANDLE SIZE		Remark
	(l cm)	Inch	
9131101	152.4	60"	M116



HYGEN™ Microfiber Dry Dust Mop

- High-pile, 100% microfiber collects and holds dust and dirt mechanically and electrostatically for superior dusting results.
- Dense 3 - 5 micrometer quality fiber removes more dust, dirt and microbes than conventional cleaning products.
- Advanced hook-and-loop backing... holds-up under harsh laundering conditions and attaches pads more securely.
- Double finished edges retain mop shape with use over time.
- Color coded products help reduce cross contamination by differentiating area of use.



Microfibre Dry Room Mop

CODE	MOP SIZE		COLOUR	REMARK
	(l x w cm)	Inch		
9131401	47 x 14	18.5" x 5.5"	Green	Q412
9131402	62.2 x 14	24.5" x 5.5"	Green	Q424
9131403	92.7 x 14	36.5" x 5.5"	Green	Q436

Microfibre Dry Room Mop with Fringe

CODE	MOP SIZE		COLOUR	REMARK
	(l x w cm)	Inch		
9131501	52.6 x 14.5	20.7" x 5.7"	Green	Q418
9131502	71.1 x 22.9	28" x 9"	Green	Q426
9131503	101.6 x 22.9	40" x 9"	Green	Q438

CLEANING & JANITORIAL WARE



HYGEN™ Microfiber Damp / Wet Dry Mop

- Premium split nylon/polyester blend microfiber provides optimal damp mopping performance.
- Dense 3 - 5 micrometer quality fiber removes more dust, dirt and microbes than conventional cleaning products.
- Advanced hook-and-loop backing... holds-up under harsh laundering conditions and attaches pads more securely.
- Double finished edges retain mop shape with use over time.
- Color coded products help reduce cross contamination by differentiating area of use.
- Patent Pending Zig-Zag design packs 17% more split microfiber into each mop.
- Proven to clean floors 45% better than string mops, 25% better than conventional microfiber
- Superior construction and premium grade materials maximize durability and product life.
- Durable through 500 laundings, 200 with bleach

Microfibre Damp / Wet Dry Room Mop

CODE	MOP SIZE		COLOUR	REMARK
	(l x w cm)	Inch		
9131201	47 x 14	18.5" x 5.5"	Blue	Q410
9131202	62.2 x 14	24.5" x 5.5"	Blue	Q411



HYGEN™ Quick-Connect Dusting Frame

- Flat profile slides easily under furniture and equipment.
- Lightweight aluminium construction for improved productivity.
- One-step connecting mechanism speeds mop assembly and changeover.
- Flat frame profile is sanitary and easy to clean.
- Replaceable hook-and-loop strips' cost efficiently extend product life.

CODE	FRAME SIZE		REMARK
	(l x w cm)	Inch	
9131301	46 x 8.9	18.1" x 3.5"	Q560 For WET & DRY Mop
9131302	61.2 x 11.4	24.1" x 4.5"	Q570 Complete with Squeegee
9131303	91.7 x 8.9	36.1" x 3.5"	Q580 For DRY Dust Mop Only



HYGEN™ Quick-Connect Handles

- Flat profile slides easily under furniture and equipment.
- Lightweight aluminium construction for improved productivity.
- One-step connecting mechanism speeds mop assembly and changeover.
- Flat frame profile is sanitary and easy to clean.
- Replaceable hook-and-loop strips' cost efficiently extend product life.

CODE	HANDLE SIZE		REMARK
	(l x w cm)	Inch	
9131701	147.3 x 4.1	58" x 1.6"	Q750

Straight Extendable Model

9131702	Closed: 121.9 cm	Open: 182.9 cm	Q755
	Closed: 48"	Open: 72"	
9131703	Closed: 50.8 cm	Open: 101.6 cm	Q745
	Closed: 20"	Open: 40"	



HYGEN™ Flexible Dusting Wands with High Performance Sleeve

- High pile sleeve for Q850 Flexi Wand
- Use damp or dry
- Excellent for dust, hair and larger debris

CODE	MOP SIZE		REMARK
	(l x w cm)	Inch	
9131901	73 x 8.3 x 3.8	28.8 x 3.2"	Q850

Microfibre Replacement Sleeve

9131902	57.7 x 8.3 x 1.9	22.7" x 3.25"	Q851
---------	------------------	---------------	------



Cotton Dust Mops / Snap On Frame & Handles

- Premium dust mop for general purpose dust mopping
- Pre treated & pre shrunk dust mop
- Fully launderable for longer service life
- Snap On frames are powder coated & corrosion resistance
- Snap On Handles complete with spring loaded clip to attach to the frame easily
- Sliding Collar locks the handle into position & allow a full 360° swivel action



Cotton Dust Mop

尘推

CODE	MOP SIZE		COLOUR	REMARK
	(l x w x h cm)	Inch		
9134101	45.7 x 12.7	18" x 5"	White	6531
9134102	61.0 x 12.7	24" x 5"	White	6532
9134103	91.4 x 12.7	36" x 5"	White	6533

Snap On Dust Mop Frame

尘推框架

CODE	FRAME SIZE		REMARK
	(l x w x h cm)	Inch	
9133901	45.7 x 12.7	18" x 5"	6522
9133902	61 x 12.7	24" x 5"	6523
9133903	91.4 x 12.7	36" x 5"	6524

Snap On Dust Mop Handle

尘推柄

CODE	HANDLE SIZE		REMARK
	(l cm)	Inch	
9134001	152.4	60"	6511



Microfibre Dust Mops / Quick Connect Frames & Handle

- Light weight aluminium frame designed with round plastic cover on both ends to protect walls & furniture
- Light weight aluminium quick connect handle with extendable function.
- 100% super fine fibre used for dust mops
- With form like edges for removing dusts & dirt in irregular corners.



Microfibre Dust Pad

除尘托布

CODE	SIZE		COLOUR	REMARK
	(l x w x h cm)	Inch		
9134401	47.0 x 14 x 1.3	18" x 5"	Green	6471
9134402	62.2 x 14 x 1.3	24" x 5"	Green	6472
9134403	92.7 x 14 x 1.3	36" x 5"	Green	6473

Quick Connect Frame

快接式拖头

CODE	SIZE		REMARK
	(l x w x h cm)	Inch	
9134201	46.0 x 8.9 x 3.8	18" x 3.5"	6421
9134202	61.2 x 8.9 x 3.8	24" x 3.5"	6422
9134203	91.7 x 8.9 x 3.8	36" x 3.5"	6423

Telescope Quick Connect Extendable Handle

快接式手柄

CODE	SIZE		REMARK
	(l x w x h cm)		
9134301	Closed: 122cm	Open: 183 cm	6412
	Closed: 48"	Open: 72"	



CLEANING & JANITORIAL WARE

WaveBrake® 35qt Side Press Mopping Combo



- The WaveBrake® mop bucket and wringer system reduces splashing, which means a safer environment, cleaner floors, and improved productivity.
- Massive capacity for the largest commercial cleaning jobs.
- Lasts 58 times longer than comparative wringers.
- Tested to exceed 50,000 wringing cycles, average wringers perform approximately 860 cycles.
- Premium tubular steel and Structural Web molded plastic.
- Accepts optional Dirty Water Bucket, 9C74.
- High efficiency side press wringer.

CODE	BUCKET SIZE (l x w x h cm)	REMARK
9131801-xx	51.1 x 39.9 x 92.7	7580

*Available Colour

■ BR ■ YE

When ordering Mop Handle add **CODE** suffix to item number (example: 9131801-YL)



All-In-One Mopping Systems

- An easy to maneuver mopping system, compact & powerful, carries all your needs for wet mopping & light cleaning.
- Ergonomically designed handles fit your hands & height, and reduce the need for bending down.
- Non marking all plastic wheels reduce the post job clean up.
- A caddy is available to carry small cleaning tools which can be removed when not in use.

CODE	BUCKET SIZE (l x w x h cm)	CAPACITY (Litre)	REMARK
9134601	67.3 x 38.1 x 88.4	25	5211



Grandmaid Side Press Mopping Combo

- The anti splash mop bucket & wringer system reduces splashing
- High efficient wringer wrings mop with 18% less effort than traditional system
- Last 58 times longer than comparative wringers
- Made of premium tubular steel & structural web molded plastic to ensure higher durability & toughness
- Ergonomically designed handles fit your hands & height, and reduce the need for bending down.
- Non marking all plastic wheels reduce the post job clean up.

CODE	SIZE (l x w x h cm)	CAPACITY (Litre)	REMARK
9134501-XX	51 x 40 x 92	33	5226

*AVAILABLE COLOUR : YELLOW & BROWN



Economy Side Press Mopping Combo

- The most economical model for your daily operation
- Complete with Non-Marking Wheels, Side Press Wringer with metal handle

CODE	SIZE (l x w x h cm)	CAPACITY (Litre)	REMARK
9132101	54 x 43 x 90	36	B040



Economy Small Version Mopping Combo

- The most economical model for your daily operation & most suitable for small environment
- Complete with Non-Marking Wheels, Side Press Wringer with metal handle

CODE	SIZE (l x w x h cm)	CAPACITY (Litre)	REMARK
9132102	34 x 28.5 x 80	20	B038



Mop Bucket with Mop Press 胶地拖桶钢柄

CODE
9132301



Sanitizing Round Bucket 提桶

CODE	SIZE (d x h cm)	CAPACITY (Litre)	REMARK
9134710-XX	26 x 26.7	10	5251
9134713-XX	28.6 x 30.5	13	5252

*Available Colour

■ GY ■ YE ■ RD

When ordering Mop Handle add **CODE** suffix to item number
(example: 9134710-GY)



Plastic Water Pail 胶水桶

CODE	CAP (gal)	CODE	CAP (gal)
9132501	1	9132504	4
9132502	2	9132505	5
9132503	3	9132506	6



Domestic Mop Dryer 拖把擰乾器

CODE	SIZE (cm)
9132401	35

CLEANING & JANITORIAL WARE

Floor Safety Signage 黄色警示牌



Economy "Wet Floor" Sign "小心地滑" 黄色警示牌

CODE	SIZE (l x w x h cm)	REMARK
9132601	30 x 3 x 63	With Chinese Wording

Economy "Cleaning In Progress" Sign "工作进行中" 黄色警示牌

CODE	SIZE (l x w x h cm)	REMARK
9132602	30 x 3 x 63	With Chinese Wording



Floor Safety Signage 黄色警示牌

- Lightweight & Versatile: makes a heavy statement about safety
- Folding design for convenient storage or minimized space
- Built in Hook for hanging item to add stability

CODE	SIZE (l x w x h cm)	REMARKS	IMPRINT
9134801	30.5 x 27.9 x 66	7111	WET FLOOR
9134802	30.5 x 27.9 x 66	7112	CLEANING IN PROGRESS
9138403	30.5 x 27.9 x 66	7113	OUT OF SERVICE



Safety Stable Signs 小心地面湿滑 警示牌

- Design for convenient storage, transport, on cleaning cart or rim caddy
- Large warning triangle with Bold graphics
- Only 3.8cm thick when stored
- Self opening feet give sign large & stable base
- Low centre gravity helps prevent tipping of signage

CODE	SIZE (l x w x h cm)	REMARKS	IMPRINT
9134804	33 x 33.6 x 66	7131	CAUTION WET FLOOR

Pop-Up Safety Cone 警告示牌

- Collapsible automatic deployed safety cone
- Wall mounted, shatter proof, storage tube allows for easy & compact storing
- Durable material to withstand abuse usage
- Storage tube mounting hardware includes tapes & screws



CODE	SIZE (l x w x h cm)	REMARKS	IMPRINT
9134901	53 x 53 x 50.8	7333	CAUTION WET FLOOR

Angle Broom Head

斜型扫把

- The Block has 2 handle hole in different angle for 2 Different cleaning purpose
- The straight hole meant for general cleaning & angled hole fits for cleaning of corners & wall edges
- Durable PP Bristles resist from wearing & breaking off

CODE	BROOM SIZE (w cm)	REMARK	BRISTLES
9141601-xx	32	6623	PP Fill



*Available Colour

■ BK ■ GR

When ordering Green Colour add **CODE** suffix to item number (example: 9141601-GR)

Corn Broom

玉米纤维扫把

- Designed for rugged indoor / outdoor cleaning
- 100% natural broom corn fibre for long life & effective pick up
- Removes fine dirt from smooth or rough surfaces

CODE	BROOM SIZE (w cm)	REMARK	BRISTLES
9142101	32	6803	Corn Fill, 2.5cm Lacquered Handle



Wash Brush & Floor Scrub

地刷

- Plastic Blocks resist splitting or delaminating to ensure durability & strength

CODE	BROOM SIZE (w cm)	REMARK	BRISTLES
9142001	23	6753	PP Fill
9142002	26	6754	Tampico Fill



Medium Floor Sweep

中型地板刷

- Designed to pick up dirt from multiple floor surfaces
- Long lasting PP & natural tampico bristles are designed to remove heavier dirt & debris from both rough wood & smooth surface
- Two threaded handle holes on either side of blocks for even wear

CODE	SWEEP SIZE (l x w x h cm)	REMARK	BRISTLES
9141901	45.5	6672	PET & PP Fill
9141902	61.0	6673	PET & PP Fill



Threaded Broom Handle

螺纹接头扫把柄

CODE	HANDLE SIZE (w x l cm)	REMARK
9141801	2.2 x 124	6351



Dustpan with Counter Brush

柜台刷带铲

CODE	SIZE (l x w x h cm)	REMARK
9141701	31.1 x 21 x 6.7	6926



CLEANING & JANITORIAL WARE

Economy Nylon Broom Head Only 尼龙扫帚头



Green & Red

CODE	BRISTLE TYPE
9140401	Soft PP Fill
9140601	Hard PP Fill

CODE	BRISTLE TYPE
9140501	Soft PP Fill

CODE	BRISTLE TYPE
9140701	Hard PP Fill



Grey

CODE	BRISTLE TYPE
9140801	Soft PP Fill

Upright Dust Pans 带盖垃圾铲

- Stylish appearance & innovative structure design.
- Fits for application in malls, canteen & hotel lobby

CODE	DUSTPAN SIZE (l x w x h cm)	REMARK
9142201	33.2 x 14.4 x 95.8	6912



Dustpan 垃圾铲



With Handle

CODE	SIZE (l x w x h cm)	REMARK
9140901	25.0 x 21 x 14.2	Small
9141001	30.2 x 25 x 15.7	Large

Lobby Dustpan

CODE	SIZE (l x w x h cm)	REMARK
9141101	28 x 26.7 x 25	With Flip Lid

Economy Dustpan 胶簸箕



CODE	SIZE (l x w x h cm)
9141401	30 x 30 x 16



Wooden Dustpan / Mop Handle 木拖布柄

CODE	SIZE (cm)
9141501	30" / 76

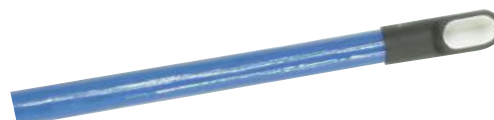

Plastic Floor Squeegees

胶刮水

- Pre treated polypropylene resists corrosion
- Twin black porous rubber blades for removing liquids & moderate dirt
- Rubber resists to oil, greases & most chemicals
- Use with 9141801 Threaded Broom Handle

CODE	SIZE (l x w h cm)	Inch	REMARK
9153346	46 x 5.8 x 8.9	18"	6831



Economy Plastic Floor Squeegees

胶刮水

- Economical model for your daily operation

CODE	SIZE (l x w h cm)	Inch	REMARK
9154318	44 x 2 x 4.5	18"	TY18



Toilet Brush

马桶刷

CODE	SIZE (L cm)	REMARK	BRISTLE
9153501	42	6792	PP Fill



Brush Holder

9153502	13.5	6793
---------	------	------

Wire Brush

铁刷

- Special Design for various applications
- For efficient removal of rust, fouling or grease
- Each features convenient hole at the end of handle for hanging
- Metal wire bristles tackle tough cleaning jobs

CODE	SIZE (L cm)	REMARK	BRISTLE
9153601	30	6764	Wired



9153601



9153602

For Tiles & Grout Brush

9153602	21.6	6783	Brass
---------	------	------	-------

Stainless Scraper

平铲

CODE	SIZE (w cm)	Inch	CODE	SIZE (w cm)	Inch
2102002	2.5	1.0	2102010	10	4.0
2102003	3.8	1.5	2102012	12.7	5.0
2102005	5.0	2.0	2102015	15	6.0
2102006	6.35	2.5	2102020	20	7.8
2102007	7.6	3.0			



CLEANING & JANITORIAL WARE



Scrub Brush

地刷

- Polypropylene Bristles in plastic block
- Designed to ease work when scrubbing tiles, floors, baseboards & countertops

CODE	SIZE (l cm)	REMARK	BRISTLE
9153901	21.5	6756	PP Fill



Counter Brushes

地刷

- Perfect for quick cleaning of counters
- All plastic structural foam handles ensure strength and durability
- Handles has hang up holes for easy storages

CODE	SIZE (l cm)	REMARK	BRISTLE
9154001	38.5	6704	PET Fill, Black



Chopping Board Cleaning Brushes

菜板刷

- User friendly handles
- PET bristles are strong, durable, resist to grease or water stains

CODE	SIZE (l x w cm)	REMARK	BRISTLE
9154101-xx	15 x 6.4	6725	PET Fill

*Available Colour: Blue, Brown, Green, Red, White, Yellow



Multi Purpose Utility Brush

多用途刷

- Versatile, suitable for any catering industries
- PET bristles are strong, durable, resist to grease or water stains
- The handles has hang up hole for easy storages

CODE	SIZE (l cm)	REMARK	BRISTLE
9153801-xx	24	6714	PET Fill
9153802-xx	52	6724	PET Fill

*Available Colour: Blue, Green, Red, White, Yellow



Glass Brushes

洗杯刷

- Designed for cleaning of glasses
- Plastic construction help prevent glasses from being chipped or broken
- Molded plastic base with suction provide a tight grip in sinks

CODE	SIZE (l cm)	REMARK	BRISTLE
9153701	20 x 9 x 20	6728	PET Fill
9153702	35 x 10.5 x 20	6727	PET Fill



Closet Organizer / Tool Holder Kit

挂架



- Helps increase productivity and efficiency through better tool storage and access.
- S-hooks hold 5/8" to 1 1/4" (1.6 cm to 3.2 cm) handle diameters.
- Deep double hooks afford easy accessibility

CODE	SIZE (l x w x h cm)	REMARK
9154201	45.7 x 8.3 x 10.8	1992
9154202	86.4 x 8.3 x 10.8	1993

BRUTE® Container without Lid

圆形垃圾桶

- Innovative venting channels make lifting out liners up to 50% easier, improving productivity and reducing the risk of injury.
- Integrated cinches secure the liner, allowing for efficient knot free liner changes. Tested to 20,000 cycles.
- Proprietary design constructed with the highest quality material plus a UV inhibitor ensures long life in even the most extreme commercial environments •
- Guaranteed to never fade, warp, crack, or crush.
- Rounded handles make lifting and moving easier, and are reinforced to resist tearing or damage from even the heaviest loads.
- Reinforced base is specifically engineered to be dragged over rough surfaces, extending life and overall durability even in the toughest environments.
- Contoured base handles improve grip and ergonomics, reducing strain and improving efficiency when emptying containers.
- Rim features integrated rib structure to increase strength and resist crushing.

CODE	SIZE	CAP		REMARK
	(Ø x h cm)	(L)	(GAL)	
9170110	39.7 x 43.5	37.9	10	2610
9170120	49.5 x 58.1	75.7	20	2620
9170132	55.9 x 69.2	121.1	32	2632
9170155	67.3 x 83.8	208.2	55	2655
9170301	61 x 80	166.6	44	2643



Dustbin Cover

圆形垃圾桶盖

CODE	SPEC	SIZE	REMARK
		(Ø x h cm)	
9170210	Fits For 10 Gal	40.6 x 2.5	2609
9170220	Fits For 20 Gal	50.5 x 4.6	2619
9170230	Fits For 32 Gal	56.5 x 4.1	2631
9170255	Fits For 55 Gal	67.9 x 5.1	2654
9170401	Fit For 9170301	62.2 x 3.8	2645



BRUTE® Dolly

垃圾桶推车

CODE	SIZE	REMARK
	(Ø x h cm)	
9170501	46.4 x 16.8	2640



For Brute Container; 20, 32, 44, 55 Gal Model

Square Brute Dustbin / Container

方形垃圾桶

- Square shape offers up to 14% more capacity than round containers.
- Tight-fitting lids help protect dry goods and other contents.
- Nesting handles allow secure fit for side-by-side use.
- Rounded corners and smooth contours are easy to clean.

CODE	SIZE	CAP		REMARK
	(l x w x h cm)	(L)	(GAL)	
9170601	59.7 x 59.7 x 73	151.4	40	3536



Square Brute Cover

方形垃圾桶盖

CODE	SIZE
	(l x w x h cm)
9170701	61 x 61 x 5.1



CLEANING & JANITORIAL WARE



Slim Jim® Containers 垃圾桶



- The industry standard in space-saving waste management.
- Efficient size and shape fits tight spaces.
- Durable, all-plastic construction is easy to clean and provides long life.
- Most specified containers behind bars and desk side.

CODE	SIZE	CAP		REMARK
	(l x w x h cm)	(L)	(GAL)	
9170801	58.7 x 27.9 x 63.2	60.1	15	3541
9170802	50.8 x 27.9 x 76.2	87.1	23	3540-60



Slim Jim Handled Cover 垃圾桶盖

CODE	SIZE	REMARK
	(l x w x h cm)	
9170902	52.8 x 28.7 x 7	2688

Swing Lid

- Swing top provides easy access for trash disposal and then swings back to hide trash from public view.
- Encourage waste separation and recycling with interchangeable, color-coded tops.

CODE	SIZE	REMARK
	(l x w x h cm)	
9170901	52.1 x 28.9 x 12.7	2673-20

Fits Model: 3540, 3541 Slim Jim

Slim Jim Trolley 垃圾桶推车

CODE	SIZE	REMARK
	(l x w x h cm)	
9171001	59.5 x 38.1 x 27.5	3551-88

Fits Model: 3540, 3541 Slim Jim

*** Colours Available:**
15Gal Slim jim in Grey & 23Gal in Black
Handled Covers in Grey
Swing Lid Covers in Black
Trolley in Black



Rigid Liner with Rim 内桶

- Designed to fit Rubbermaid and other manufacturers' containers
- One piece plastic construction for long product life
- Easy to clean
- Prevents leaks & messes from occurring on the floor

Round with Rim

CODE	SIZE	CAP		REMARK
	(Ø x h cm)	(L)	(GAL)	
9171101	36.8 x 76.5	83.3	22	3552



9171201



9171301 & 9171302

Square with Rim

CODE	SIZE	CAP		REMARK
	(l x w x h cm)	(L)	(GAL)	
9171201	47.3 x 47.3 x 86.4	189.3	50	3564
9171301	41.3 x 41.3 x 72.4	93.4	24.6	3566
9171302	46.4 x 46.4 x 74	134.4	35.5	3567

Untouchable® Square Container 垃圾桶



- Sleek design for a professional image.
- Durable and crack resistant, even under tough indoor/outdoor conditions.
- Perfect for hotel lobbies, offices, restrooms, shopping malls, restaurants and other public locations.

CODE	SIZE (l x w x h cm)	CAP (L)	(GAL)	REMARK
9171401	41.9 x 39.4 x 78.5	87.1	23	3569-88



Swing Lid for 9171401 垃圾桶盖

CODE	SIZE (l x w x h cm)	REMARK
9171403	40.6 x 40.6 x 10.2	2689-88



Step-On Containers 垃圾桶

- Quiet, heavy-duty pedal for hands-free sanitary use.
- Features slow-close integrated lid damper to help keep odors and bacteria from escaping.
- Tight-fitting, overlapping lid to help contain odors.
- Tough, puncture-resistant, all-plastic construction.



Round

CODE	SIZE (Ø x h cm)	CAP (L)	(GAL)	REMARK
9171501	33.7 x 39.1	17	4.5	6142-W

Rectangle



PRODUCT CODE	9171601-XX	9171602-XX	9171603-XX	9171604-XX
MANUFACTURE CODE	6143	6144	6145	6146
CAPACITY	30.3 L / 8 Gal	45.4 L / 12 Gal	68.1 L / 18 Gal	87.1 L / 23 Gal
OVERALL DIA (l x w x h cm)	41.3 x 40 x 43.5	41.3 x 40 x 60	50.2 x 41 x 67.3	50.2 x 41 x 82.6
COLOUR AVAILABLE	Beige & Red	Beige & Red	Beige & Red	Beige & Red

*Available Colour

■ BG ■ RD

When ordering BEIGE Colour add **CODE** suffix to item number (example: 9171601-BE)

Spare Parts Accessories for Step On Container

CODE	FITS FOR	REMARK
------	----------	--------

Black Lifter

9171701	9171602 (6144) Bin	6144-L1
9171702	9171603 (6145) Bin	6145-L1
9171703	9171604 (6146) Bin	6146-L1

Black Pedal

9171801	9171603 (6145) & 9171604 (6146)	6145-L3
---------	---------------------------------	---------

CLEANING & JANITORIAL WARE

*Available Colour For Container & Cover

■ GR ■ GY ■ RD □ WH

When ordering GREEN add **CODE** suffix to item number (example: 9175311-GR)

**9175313 (32 Gal) & 9175314 (44 Gal) only Comes in Grey



All Purpose THOR® Container

圓形垃圾桶

- All Plastics construction will not rust, chip or peel & resistance to dents
- Comes with an ergonomic handle with a smooth & comfortable feeling
- Reinforced rims increase strength & durability
- Comes with four trash liner grooves for easy attachment without the need to tie knots
- Four vent channels provides 50% less worker exertion when lifting a filled trash liner compared with a traditional container
- Bottom hand grips of 30 mm width assist in emptying of trash
- Double & ribbed base increases stability & dragging capacity

CODE	SIZE	CAP		REMARK
	(Ø x h cm)	(L)	(GAL)	
9175311-XX	40 x 44	38	10	1011
9175312-XX	49 x 57	75	20	1012
9175313	56 x 70	121	32	1013
9175314	67 x 84	166	44	1014

THOR® Container Cover

垃圾桶盖

CODE	SIZE	SPEC	REMARK
	(Ø x h cm)		
9175411-xx	40.6 x 5.2	Fit For 9175311	1611
9175412-xx	50.7 x 6.6	Fit For 9175312	1612
9175413-xx	57.0 x 5.9	Fit For 9175313	1613
9175414-xx	62.2 x 6.0	Fit For 9175314	1614

Dolly Only For THOR® Containers

圓形小车

- Easy mobility & maneuverability of heavy loads
- Swivel castors offer easy mobility
- Attach trash containers with ease

CODE	SIZE	REMARK
	(Ø x h cm)	
9175700	46.4 x 16.8	1811

Square THOR® Square Container

方形垃圾桶

- Square shapes offers up to 27% more capacity than round container
- Comes with ergonomic handles with a smooth & comfortable feeling
- Reinforced rims add strength and durability & thick wall up to 4mm
- Bottom hand grip of 30mm width assist in emptying of trash
- Tight fitting lids help protect the contents from insects & eliminates odors
- Optional square dollies enhance mobility



CODE	SIZE	CAP		REMARK
	(l x w x h cm)	(L)	(GAL)	
9175501	54.6 x 54.6 x 57.2	106	28.6	1231

Square THOR® Cover

垃圾桶盖

CODE	SIZE	SPEC	REMARK
	(l x w x h cm)		
9175601	55.9 x 55.9 x 5.1	Fit For 9175501	1661

Square THOR® Dolly

方形小车

CODE	SIZE	REMARK
	(l x w x h cm)	
9175712	43.8 x 43.8 x 15.9	1812



Slim Svelte™ Container

垃圾桶

- The slim rectangle shape enhance space efficient & fits tight spaces
- Vent channels are designed for easy lifting of a filled trash liner & less work exertion
- Comes with an ergonomic handle with a smooth & comfortable feeling
- Comes with four trash liner grooves for easy attachment without the need to tie knots
- Bottom hand holds assist in emptying trash

CODE	SIZE	CAP		REMARK
	(l x w x h cm)	(L)	(GAL)	
9175701	50.7 x 27.2 x 63.2	60	16	1211
9175702	50.7 x 27.2 x 75.6	87	23	1213



Slim Svelte™ Handled Cover

垃圾桶盖

CODE	SIZE	REMARK
	(l x w x h cm)	
9175801	52.3 x 28.8 x 7	1643



Swing Cover

翻门桶盖

CODE	SIZE	REMARK
	(l x w x h cm)	
9175802	52.3 x 28.8 x 11.5	1644



Slim Svelte™ Dolly

垃圾桶

- Sturdy structural foam construction will no dent, rust or chip
- 7.5 cm non marking castors
- Easy mobility & maneuverability of heavy load

CODE	SIZE	FIT FOR	REMARK
	(l x w x h cm)		
9175703	51.6 x 29 x 26	9175701 & 9175702 Bin	1814



Step On Containers

脚踏式垃圾桶

- Tight fitting lid helps contain odors & prevent against insects.
- Tough, puncture resistant to damage / dent.
- Quite, heavy duty pedal for hands free sanitary use
- Built in mute, prevent noise effectively



PRODUCT CODE	9175930	9175945	9175968	9175987
MANUFACTURE CODE	1252	1253	1254	1255
CAPACITY	30 L / 8 Gal	45 L / 12 Gal	68 L / 18 Gal	87L / 23 Gal
OVERALL DIA (l x w x h cm)	41.3 x 40 x 40	41.3 x 40 x 60	50.2 x 41 x 67.3	50.2 x 41 x 82.6
COLOUR AVAILABLE	Beige	Beige	Beige	Beige

CLEANING & JANITORIAL WARE



Economy Rectangular Pedal Bin
长方形垃圾桶

CODE	SIZE (l x w x h cm)	CAP (L)	REMARK
9172030	41 x 39 x 45	30	XM30
9172045	41 x 40 x 62	45	XM45
9172068	50 x 41 x 68	68	XM68
9172087	50 x 41 x 85	87	XM87



Slim Plastic Pedal Bin
脚踏胶垃圾桶

CODE	SIZE (l x w x h cm)	CAP (L)	REMARK
9172101	36 x 21.8 x 42.5	22	1286-419

Wheel Bin with Concealed Pedal
垃圾桶

- Easy & smoothly opening the lid with a foot pedal. - Hygienic exhaust the food waste because the lid can be opened without using hands
- No splashing of dirt because the lid closes slowly and gently with the use of a damper
- Durable components of the foot pedal device with special reinforced plastic
- Lids can be completely opened and turned over backward with the hands, causing no trouble during collection by vehicles
- Edge prevents rainwater from penetrating
- Easily maneuverable for transport and discharge



CODE	SIZE (w x l x h cm)	CAP (L)	REMARK
9172401	48 x 56 x 92.5	120	Blue Lid
9172402	48 x 56 x 92.5	120	Yellow Lid
9172403	48 x 56 x 92.5	120	Orange Lid
9172404	48 x 56 x 92.5	120	Full Green
9172405	48 x 56 x 92.5	120	Full Yellow

Wheel Bin with Plastic Pedal
胶脚踏垃圾桶

CODE	SIZE (l x w x h cm)	CAP (L)
9172901	47.0 x 55.0 x 65.8	60
9173001	48.0 x 56.0 x 78.0	80
9173101	48.0 x 55.0 x 94.0	120



Wheel Dustbin with Metal Pedal

垃圾桶 (铁脚踏)

CODE	SIZE (l x w x h cm)	CAP (L)
9173201	58 x 73 x 108	240



Wheel Bin Only No Pedal

圾桶 (无脚踏)

CODE	SIZE (l x w x h cm)	CAP (L)
9172501	47 x 55 x 65.8	60
9172601	48 x 56 x 78	80
9172701	55 x 48 x 94	120
9172801	73 x 58 x 108	240



Bulk Dustbin with 4 Wheel Plastic

垃圾桶 (4个胶轮)

CODE	SIZE (h x w x d cm)	CAP (L)
9173301	117.5 x 131 x 77.5	660



Black HDPE Trash Bag

垃圾袋

CODE	SIZE (l x w inch)	THICKNESS (micron)	
9172405	30 x 34	~28	Black
9172406	36 x 48	~30	Black
9173403	36 x 48	~45	Black
9173404	36 x 48	~45	White

* Coloured Trash Bags are available, please contact us for more details





Structural Foam Tilt Truck

滚塑倾斜斗车



- Durable molded trucks handle heavy loads with ease
- Fits through standard commercial and onto elevators easily.
- Non-marking casters reduce touch-up cleaning.
- Constant force design allows for controlled dumping by one person.
- Easy to clean and virtually maintenance free.
- Unique "steering wheel" handle provides excellent maneuvering capability.
- Optional domed lid available.

CODE	SIZE (l x w x h cm)	LOAD	REMARK
9173601	163.8 x 76.8 x 96.5	272.2 kg	1011

Tilt Truck Lid

方形斗车盖



CODE	SIZE (l x w x h cm)	FITS FOR	REMARK
9173602	154.9 x 80.6 x 22.2	9173602	1028



Structural Foam Tilt Truck, Standard Duty

滚塑倾斜斗车

- Durable molded trucks handle heavy loads with ease
- Fits through standard commercial and onto elevators easily.
- Non-marking casters reduce touch-up cleaning.
- Constant force design allows for controlled dumping by one person.
- Easy to clean and virtually maintenance free.
- Unique "steering wheel" handle provides excellent maneuvering capability.
- Optional domed lid available.

CODE	SIZE (l x w x h cm)	LOAD	REMARK
9173801	145.7 x 68.3 x 86	385.6 kg	9T18

Tilt Truck

滚塑倾斜斗车

- Industrial strength construction transports heavy loads with ease.
- Seamless one-piece molded truck bodies with reinforced lip
- Sturdy, plastic construction won't rust, dent, chip, or peel and is easy to clean.
- 4" (10.2 cm) center swivel back caster provides easy maneuvering.
- Durable one piece, 10" (25.4 cm) blow-molded polypropylene inset wheels protect surroundings.
- Powder coated steel frame for corrosion resistance.
- 300 LB weight load
- Easy to handle and maneuver through commercial doorways and onto elevators.
- Constant force design allows for controlled dumping by one person.
- Inset wheels on 1/2 cu. yd. (.4 m3) and 1 cu. yd. (.8 m3) models protect walls, fixtures and patrons.
- Smooth surface is easy to clean and resists pitting and corroding.

CODE	SIZE (l x w x h cm)	LOAD	REMARK
9173802	183.5 x 85.1 x 111.1	272.2 kg	9T18

Tilt Truck Lid

斗车盖



CODE	SIZE (l x w x h cm)	FITS FOR	REMARK
9173803	176.5 x 86.4 x 21.6	9173802	4317

Cube Trucks

方形斗车

- Metal frame provides durable support.
- Conceals loads without reducing capacity.
- USDA Meat & Poultry Equipment Group Listed.
- Assists in complying with HACCP guidelines.
- Diamond wheel placement for maneuverability.

CODE	SIZE (l x w x h cm)	LOAD	REMARK
9173401	108.6 x 71.1 x 83.4	181.4 kg	4612



* Lid Shown are Optional

Cube Truck Lid

方形斗车盖

CODE	SIZE (l x w x h cm)	FITS FOR	REMARK
9173501	109.5 x 69.8 x 21.6	9173401	4613



Multi Purpose Tilt Truck

滚塑倾斜斗车

- Fits through standard commercial doorways & onto elevators easily
- Angled design on front end assist in tilting to release loads
- Industrial strength trucks handle heavy loads with ease
- Insert wheels position helps prevent damage to walls or equipment
- smooth surfaces are easy to clean & resist corrosion

CODE	SIZE (l x w x h cm)	LOAD	REMARK
9176001	183.2 x 85.7 x 111.4	390 kg	4522



Cube Truck

方形斗车

- For waste collection, material transport & laundry handling
- Structural foam of industrial strength transports heavy loads with ease
- Metal frame provides durable support
- Domed, hinged lid conceals loads without reducing capacity

CODE	SIZE (l x w x h cm)	LOAD	REMARK
9176101	108.6 x 71.1 x 83.8	180 kg	4711

Cube Truck Lid

方形斗车盖

CODE	SIZE (l x w x h cm)	REMARK
9176102	109.6 x 69.9 x 21.6	4713





Mobile 2-Step Stool

可移动脚踏

- Heavy-duty stepstool glides easily on retractable rubber casters.
- Supports loads up to 350 lbs (158.8 kg).
- Soft, slip resistant pads on both steps.
- Wheels retract when stepped on.
- Heavy-duty plastic construction will not damage walls or furniture



CODE	SIZE (l x h cm)	LOAD	REMARK
9175001-xx	34.3 x 40.6	158.8 kg	2523

*Available Color

■ BG ■ BK

When ordering BLACK add **CODE** suffix to item number
(example: 9915001-XX)



Aluminium Ladder with Handle

铝有柄楼梯

CODE	SPEC
9174903	3 Steps
9174904	4 Steps
9174905	5 Steps
9174906	6 Steps
9174907	7 Steps
9174908	8 Steps
9174909	9 Steps
9174910	10 Steps



Grandmaid™ Janitorial Cleaning Cart 清洁推车

- An ideal Solution for collecting Trash & transporting cleaning tools to effectively increase cleaning efficiency
- Smooth surface for easy cleaning
- Zipped waste bags assist in emptying of waste
- 20cm & 10cm non marking castors enhance maneuverability

CODE	SIZE (l x w x h cm)	REMARK
9135001	116.8 x 55.2 x 97.5	5011

Optional Accessories

CODE	SIZE (l x w x h cm)	REMARK
------	------------------------	--------

Drawer

9135002	48.5 x 25.7 x 26	5266
---------	------------------	------



*Items shown with an option of 2 x 5266 drawer

Grandmaid™ Housekeeping Cart 客房服务推车

- A complete solution for housekeeping in hotels & service apartment.
- Durable molded construction with smooth surfaces, easy to clean
- 20cm castors provides easy maneuverability
- User friendly handles are easy to grip
- Bumpers available at four corners to protect the walls & equipment

CODE	SIZE (l x w x h cm)	REMARK
9135101	152.4 x 55.96 x 127	5021



Linen Cart 浴巾推车

- Compete with water proof anti-fungus canvas
- Comes with 6 heavy duty castors for easy maneuverability even in compact space & additional 40% load compared to other model
- Cart are delivered dismantled & Flat pack for low shipping cost

CODE	SIZE (l x w x h cm)	REMARK
9133801	90 x 50 x 80	EX9050



Deluxe Carry Caddy 工具箱

- Perfect for carrying tools or cleaning supplies
- Conveniently fits on cleaning & housekeeping carts
- User friendly handles fits your hand & allow for comfort grip
- Securely holds spray bottle & other common cleaning tools
- Stackable for space saving during storage

CODE	SIZE (l x w x h cm)	REMARK
9135401	38.6 x 28 x 17	6931



Bath Mat 浴缸垫

- Does not contain natural latex, which may cause allergic reaction
- Perfect for shower stall or bathtub
- Suction back to stay firmly in place & textured surface prevent slippage
- Containing antibacterial agents, inhibits the growth of bacteria / mildew resistant

CODE	SIZE (l x w x h cm)	REMARK
9135501	57.2 x 35.6	6961





Cigarette Butt Bin (Floor Standing)
大容量烟蒂桶

CODE	SIZE (Ø x h cm)	SPEC (L)
9175401	30 x 85	1



Cigarette Butt Bin (Wall Mounted)
挂壁烟蒂桶

CODE	SIZE (Ø x h cm)	SPEC
9175301	8 x 8 x 48	2.45



Round Bin with Open Top
圆形桶

CODE	SIZE (Ø x h cm)	SPEC
9174201	25 x 60.5	Silver Matt S/Steel
9174202	25 x 60.5	Black Metal Coating



Round Bin with Flat Swing Top (No Ashtray Comp)
圆形桶

CODE	SIZE (Ø x h cm)	SPEC
9174001	30.5 x 64.5	Silver Matt S/Steel
9174002	30.5 x 64.5	Black Metal Coating

Square Bin with Ashtray Top

方形钢烟灰桶

CODE	SIZE (l x w x h cm)	SPEC
9174301	24 x 24 x 62	Silver Matt S/Steel
9174302	24 x 24 x 62	Black Metal Coating



Bin with Ashtray Top

菊形顶钢烟灰桶

CODE	SIZE (Ø x h cm)	SPEC
9174101	25 x 60	Silver Matt S/Steel
9174102	25 x 60	Black Metal Coating



Lobby Bin with Ash Urn

大理石身钢烟灰桶

CODE	SIZE (l x w x h cm)	SPEC
9174601	38 x 20 x 80	Black Marble



CLEANING & JANITORIAL WARE



Black Base

CODE	SIZE (h x w cm)
9180401	6.0 x 10.0
9180501	7.5 x 11.5



White Base

CODE	SIZE (h x w cm)
9180801	6.0 x 10.0
9180901	7.5 x 11.5



Table Top, Black Base

CODE	SIZE (l x h cm)
9184001	9 x 5.5
9184101	9 x 5.5



White Base

CODE	SIZE (w x h cm)
9181001	9.0 x 12.5
9181101	12.5 x 17.0



Black Base

CODE	SIZE (l x w cm)
9180601	9.0 x 12.5
9180701	12.5 x 17.0



CODE	SIZE (l x w cm)
9183201	12.7 x 30.48



White Base

CODE	SIZE (l x w cm)	REMARK
9180101	18 x 7.5	Red Word
9180201	18 x 7.5	Black Word



Black Base

CODE	SIZE (l x w cm)
9181401	18 x 7.5



CODE	SIZE (l x h cm)	REMARK
9181201	30 x 7.5	Black
9181301	30 x 7.5	White



CODE	SIZE (l x h cm)
9180301	12.7 x 30.4



CODE	SIZE (l x h cm)
9182201	30 x 9



CODE	SIZE (l x h cm)
9183101	22.86 x 7.62

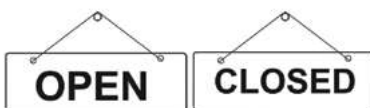

CODE	SIZE (l x w cm)
9183301	20 x 9



CODE	SIZE (l x w cm)
9183801	30 x 7.5



CODE	SIZE (l x w cm)
9183701	7.62 x 22.86

CLEANING & JANITORIAL WARE



White Base

CODE	SIZE (l x w cm)	REMARK
9181501	5 x 15	Men
9181601	5 x 15	Women
9181701	5 x 15	Men / Women

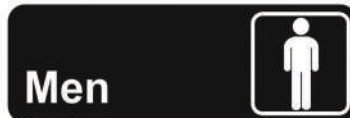

Black Base

CODE	SIZE (l x h cm)	REMARK
9182401	22.86 x 7.62	Men
9182501	22.86 x 7.62	Women
9182601	22.86 x 7.62	Men / Women



CODE	SIZE (l x h cm)	REMARK
9181801	5 x 15	White base
9181901	5 x 15	Black base

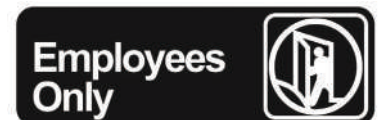

CODE	SIZE (l x h cm)	REMARK
9182001	5 x 15	White base
9182101	5 x 15	Black base

CODE	SIZE (l x h cm)	REMARK
9182901	22.86 x 7.62	Pull
9183001	22.86 x 7.62	Push

CODE	SIZE (l x h cm)
9182301	22.86 x 7.62



CODE	SIZE (l x w cm)
9182701	7.62 x 22.86

CODE	SIZE (l x w cm)
9182801	7.62 x 22.86

CODE	SIZE (l x w cm)
9183401	30 x 7.5



CODE	SIZE (l x w cm)
9183901	13 x 30

CLEANING & JANITORIAL WARE



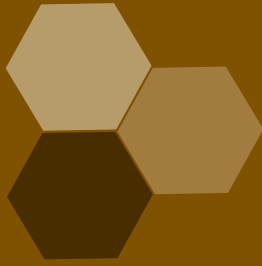

Bar

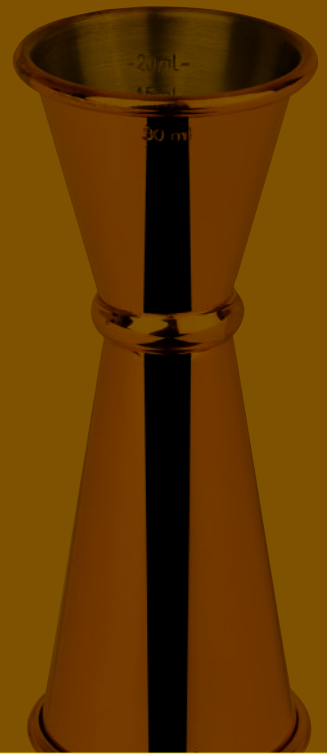



PIAZZA

SUITABLE FOR
Ø mm 18,5 > 21



Tappo versatore SteadySpout

SteadySpout pourer

Code: 7042101



STEADYSPOUT

THE INNOVATIVE CONTINUOUS POURER

With SteadySpout, the rate of pouring is always constant at 157BPM, the unit of measurement used by bartenders to perfectly calibrate the quantity of liquid in the preparation of cocktails.



NEVER

ALWAYS LIKE NEW! Special plastic with "memory" returns to the original shape simply by putting it through the dishwasher.



STURDY

THE PERFECT SYNTHESIS! Composed of only 2 pieces rather than 4. Sturdier and more resistant to wear and tear. Longer duration compared to the other competitors.



ACCURATE

ABSOLUTELY EFFECTIVE! Pouring speed of the liquid guaranteed by the air intake. No spills either at the start or end of the pouring. Perfect for the jumping technique.



UNIVERSAL

UNRIVALLED GRIP! Design and material of the reed valves offer maximum grip. The double diameter module makes it suitable for bottles with necks of diameters from ø18 to ø21.5 mm.



PATENTED

ITALIAN PRIDE! Conceived, developed and entirely designed by PIAZZA's technical office. Entirely manufactured in Italy

TECHNICAL SPECIFICATIONS

- Reed in AISI 304 18/10 laser processed stainless steel
- Perfectly calibrated diameter, tapering and inclination of the reed, both inside and outside
- Dishwasher friendly

FEEL THE BEAT MIX THE DRINKS

Premium Series



Stainless Steel Speed Pourer
倒酒头

CODE	SPEC
7042101	Suitable for Ø mm 18,5 > 21



Free Flow Chrome Tap Speed Pourer
(Silicon Rubber)
倒酒头

CODE	SPEC
7041601	Suitable for Ø mm 17,5 > 18



Stainless Steel Speed Pourer With Lid
不锈钢有盖倒酒头

CODE	SPEC
7040201	Medium Flow



Metric Portion Pourer
倒酒头

CODE	CAPACITY
7041715	15ml per Shot
7041730	30ml per Shot



“HAPPY HOUR” Plastic Speed Pourer
塑料快速倒酒头

SIZE
(l cm)
7040101-xx

*Available Colour

GR OR BK YE

When ordering Green add **CODE** suffix to item number
(example: 7040101-GR)



A complete range of pourers,

all aimed at guaranteeing not just "top" performance in all situations, but also max comfort, practicality, ease of use and hygiene.

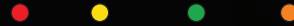

The "Planet One Perfect Pourer" is the result of a partnership between PIAZZA and PLANET ONE, the bartender school famed throughout Europe. This accessory adds the following important advantages to the already highly acclaimed Versus :

- PERFECT POURING THANKS TO "FREE POURING PLANET ONE"
- CONSTANT FLOW OF THE LIQUID
- A POURING ANGLE IDEAL FOR V POURING
- PERFECT "NO DRIP" POURING EVERY TIME



Store & Pour "VERSUS" 胶料瓶器

CODE	CAPACITY (lit)
7060105	0.5
7060110	1.0
7060120	2.0



Spare "VERSUS" Store & Pour 胶料瓶器

CODE	CAPACITY (lit)
7060905	0.5
7060910	1.0
7060920	2.0



Premium Series



Double Jigger
双头量杯

CODE	CAP (ml)
7021615	30 / 50



2-Pcs Cocktail Shaker
摇酒器

CODE	CAP (ml)
7021800	600



Double Jigger
不锈钢双头量杯

CODE	CAP (oz)
7021613	1 / 3
7021614	2 / 3



Stainless Steel Bar Spoon
不锈钢鸡尾酒调匙

CODE	SIZE (l cm)
7031328	28
7031225	25 Fork Tip



Julep Mug
杯

CODE	CAP (ml)
7021748	480



Stainless Steel 2-Pcs Boston Shaker
不锈钢摇酒器

CODE	SIZE (l cm)
7021101	



Mixing Glass
杯

CODE	CAP (ml)
7031965	650



Julep Strainer
鸡尾酒匙

CODE	SIZE (l cm)
7031415	15



Stainless Steel Heavy Duty Cocktail Strainer
不锈钢鸡尾酒过滤器

CODE	SIZE (l cm)
7030301	16

Premium Series



Bottle Opener
开瓶器

CODE	SIZE
	(l cm)
7011514	14



Lemon/Lime Squeezer
柠檬榨汁器

CODE	SIZE
	(l cm)
7031401	



Table Top Rapid Pull
桌试自动开瓶器

CODE	SIZE
	(l cm)
7010701	



Wall Mounted Rapid Pull Opener
开瓶器

CODE	SIZE
	(l cm)
7010702	



Stainless Steel Wine Bucket
钢香槟桶

CODE	SIZE
	(Ø x h cm)
7131721	21 x 21 Wine Bucket
7131821	25 x 65 Stand



**Stainless Steel Champagne /
Punch Bowl (Mirror Finish)**
不锈钢香槟碗

CODE	SIZE
	(Ø cm)
4032740	40



Plastic Ribbed Bar Pestle
塑料杵

CODE	SIZE
	(l cm)
7030821	21.5



Economy Stainless Steel Bottle Opener
钢组合式开瓶器

	SIZE (l cm)
7010301	11



Stainless Steel Waiter Opener
不锈钢开瓶器

	SIZE (l cm)
7010101	11.1



Economy Double Pull Cork Screw Wine Opener
钢组合式开瓶器

CODE	SIZE (l cm)
7010601	12



Economy Stainless Steel Bottle Opener
红胶柄钢开瓶器

CODE	SIZE (l cm)
7010501	13.5



Table Top Rapid Pull Corkscrew / Bottle Opener
桌试自动开瓶器



CODE	SIZE (l cm)
7011701	27.9



Stainless Steel Deluxe Wine Opener
椭圆柄钢开红酒瓶器

CODE	SIZE (l cm)
7010801	18



Heavy Gauge Opener
开瓶器

CODE	SIZE (l cm)
7010901	17.8



Stainless Steel Double Loop Bottle Opener
双环开瓶器

CODE	SIZE (l cm)
7011301	17.8



Wall-Mounted Bottle Opener
壁式开瓶器

CODE	SIZE (l cm)
7011201	



Stainless Steel Small Utility Bowl
不锈钢配料碗

CODE	SIZE (l cm)
7020101	10



Stainless Steel Wine Measure
不锈钢酒量器

CODE	CAPACITY (ml)	
7020201	30	(*no Government Stamp)
7020202	30	(*government Stamp)



Stainless Steel Double Zigger
不锈钢双头量酒杯

CODE	CAPACITY (cc)
7021350	25 / 50
7021340	20 / 40
7021330	20 / 30



Stainless Steel Double Sided Wine Mesurer
不锈钢双头量器

CODE	CAPACITY (cc)
7020301	14 / 25
7020302	25 / 33
7020303	25 / 42



Stainless Steel Cocktail Shaker
不锈钢调酒器

CODE	CAPACITY (cc)
7020503	350
7020502	530
7020501	750



Polycarbonate Double Sided Wine Mesurer
双头量酒器

CODE	CAPACITY (cc)
7020448	25 / 48
7020428	15 / 28



Polycarbonate Clear Cocktail Shaker
胶料调酒器

CODE	CAPACITY (cc)
7020718	350
7020717	530
7020716	750



Stainless Steel Cocktail Shaker (Economy)
钢调酒器(经济型)

CODE	CAPACITY (ml)
7020608	350
7020610	530
7020611	750



Stainless Steel Cocktail Shaker
不锈钢调酒器

CODE	CAP (oz)
7020801	30



Stainless Steel Cocktail Shaker
不锈钢调酒器

CODE	CAP (oz)
7021001-xx	30

*Available Colour

■ RD ■ BK

When ordering Red add **CODE** suffix to item number
(example: 7021001-RD)



Julep Strainer
果汁滤网

CODE	SIZE (l x h cm)
7030101	8 x 16



Stainless Steel Bar Spoon
钢调酒匙

CODE	SIZE (l cm)
7030430	30.0 / 12"



Mixing Glass
玻璃杯

Libbey

CODE	CAPACITY (oz)
7020901	16



Stainless Steel Malted Milk Cup
麦芽奶杯

CODE	Size (l cm)	(inch)	CAP (oz)
7021201	6.7	8	30



Stainless Steel Cocktail Bar Strainer
不锈钢鸡尾酒过滤器

CODE	SIZE (l cm)
7030201	



Stainless Steel Bar Spoon (Red Tip)
有红盖钢鸡尾酒调匙

CODE	SIZE (l cm)
7030526	26 / 10"



Stainless Steel Lemon Squeezer
不锈钢柠檬夹

CODE	SIZE (l cm)
7030601	



Stainless Steel Lemon Clip
不锈钢蝶形柠檬夹

CODE	SIZE (l cm)
7030524	24.5



Plastic Muddler
搅拌棒

CODE	SIZE (l cm)
7030725	25



Wood Muddler
木搅拌棒

CODE	SIZE (l cm)
7030721	21



Glass Rimmer
沾盐器

CODE	TYPE
------	------

7030903 For 3 Tier
7030902 For 2 Tier





Duststopper For Speed Pourer
防尘塞



CODE	SIZE (cm)
7042001	11



Chromed Tapered Speed Pourer
经济型铬制中度流量倒酒头

CODE	TYPE
7040401	Medium Flow

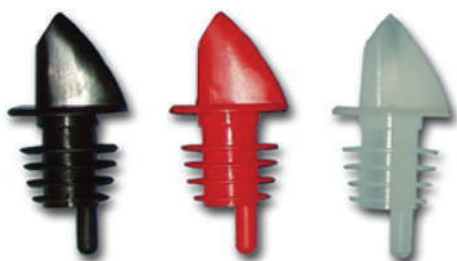

Free Flow Speed Pourer
塑料瓶塞

CODE	SPEC
------	------

7042202-xx

*Available Colour

CL RD BK

When ordering RED add **CODE** suffix to item number
(example: 7042202-RD)



Whiskey Pourer
塑料瓶塞

CODE	SPEC
------	------

7042302-xx

*Available Colour

RD CL

When ordering RED add **CODE** suffix to item number
(example: 7042302-RD)





Wine Bottle Bracket 单头酒架



TYPE	
For	
7041001	0.75 - 1Ltr Shelf Mount
7041101	0.75 - 1Ltr Wall Mount

Aluminium bracket for securely attaching bottles to either a shelf or wall.

Free Standing Wine Bottle Rotary Stand (6 Bottles) 六头酒架



CODE	CAPACITY (lit)
7041201	

Chrome plated and Aluminium rotary stand set, ideal for attaching bottles when wall space isn't an option. Swivels to easily select a different bottle.



Champagne Stopper 香槟塞

SIZE (l cm)
7041301



Bottle Plastic Stopper 塑料瓶塞

CODE	SPEC
7041801-xx	2 Pcs / Packet

*Available Colour

■ YE
 ■ RD
 ■ BL
 ■ GR

When ordering Green add **CODE** suffix to item number (example: 7040101-GN)



Eclipse "PUSH UP" Wine Dispenser 量酒头

CODE	CAPACITY
7040901	30ml/Dispense

Black eclipse conical design spirit measure. The most effective and accurate form of dispensing spirits. clips into any form of bracket.





Epivac Duo
葡萄酒真空泵

CODE	SIZE
------	------

7160601

Dual-purpose pump - saves opened bottles of wine and champagne

Epivac Wine Vacuum Pump
葡萄酒真空泵

CODE	SIZE
------	------

7160701 Pump
7160901 Stopper (Set of 4)

Vacuum pump, for preserving wine in opened bottles
Corks for Vacuum pump EPIVAC and EPIVAC Duo



Epivac Champagne Pump Stopper
香槟塞

CODE	SIZE
------	------

7160801

Cork for Vacuum pump EPIVAC Duo

CLEANING BEADS
清洁珠

CODE	SIZE
------	------

7161001

Decanter-cleaning beads

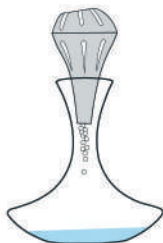



Plastic Insert Condiment Box Hinge Lid
翻盖胶内盒钢身调料盒

CODE	TYPE (comp)	SIZE (l x w x h cm)
2040303	3	23.0 x 15.0 x 9.0
2040304	4	30.5 x 15.0 x 9.0
2040305	5	38.0 x 15.0 x 9.0
2040306	6	45.5 x 15.0 x 9.0



Deluxe Condiment Container
调味品容器

CODE	SIZE
7050103	3 Comp (Quat)
7050104	4 Comp (1-1/2 Pint)
7050105	5 Comp (1-1/4 Pint)
7050106	6 Comp (Pint)



Bar & Shelf Textliner
酒吧垫

CODE	SIZE (l x h cm)	(inch)
7050501-xx	5 x 50.8	2" x 20"

*Available Colour

RD BK GR CL

When ordering Red add **CODE** suffix to item number
(example: 7050501-RD)



Interlocking Shelf Mats
防滑垫

CODE	SIZE (l x w cm)	(inch)
7051713	33 x 33	12.5 x 12.5

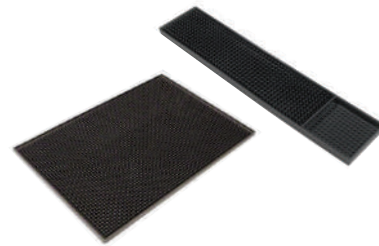

Service & Bar Mat (Economy)
酒吧垫

	SIZE (l x h Inch)
7050401	3 x 23
7050402	12 x 18



Rect Rubber Non-Grease Floor Mat
长形胶地毯

CODE	SIZE (l x w x h cm)	(feet)
7050601	7.62 x 12.7 x 1.27	3 X 5



Plastic Bar Caddy (Economy)
酒吧用品盒(经济型)

CODE	SIZE (l x w x h cm)
7050801	24 x 14.5 x 10

BEVERAGE & BAR



Plastic "SWORD" Cocktail Pick
胶剑形搅水棒

CODE	SIZE		Pcs
	(l cm)		
7051009	9		500



Plastic Stirrer
搅水棒

CODE	SIZE		
	(cm)	(inch)	Pcs
7050918-xx	18.5	7.5	250

*Available Colour

CL BK

When ordering BLACK add **CODE** suffix to item number
(example: 7050918-BK)



Frill Toothpick
花纸牙签

CODE	SIZE		Pcs
	(l cm)	(inch)	
7051225	6.5	2.5	1000
7051240	10.2	4.0	1000



Parasol Cocktail Umbrella
纸雨伞牙签

CODE	SIZE	
	(l cm)	Pcs
7051110	10	144



1 Ply White Napkin (60pkt / Ctn)
一层白色纸巾

CODE	SIZE
	(l cm)
7051401	32 x 33



Paper Cocktail Serviette / Napkin
盒装纸巾

CODE	SIZE
	(l cm)
7051324	24 x 24



Flexible Drinking Straw

吸管

CODE	SIZE (l cm)	Pcs / Pkt
7051520-xx	20	250

*Available Color

■ RD ■ BK □ CL

When ordering RED add **CODE** suffix to item number
(example: 7051520-RD)



Cocktail Straight Straw

吸管

CODE	SIZE (l cm)	Pcs / Pkt
7051612-xx	12.5	250

*Available Color

■ RD ■ BK

When ordering RED add **CODE** suffix to item number
(example: 7051612-RD)



Stainless Steel Speed Rack

不锈钢酒瓶架

CODE	SIZE	
	(l cm)	(inch)
7060521	53.3	21
7060531	78.7	31
7060541	104	41

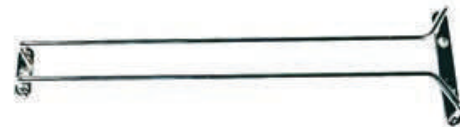

Chrome Metal Hanging Glass Rack

铬金属杯架

CODE	SIZE	
	(l cm)	
7060610	25.4	10
7060616	40.6	16
7060624	60.9	24





Store 'N' Pour

胶料瓶器

TRAEX®

CODE	CAPACITY
------	----------

7061016	1-Pint
7061032	1-Quart
7061064	Half-Gallon



Store 'N' Pour (Economy)

胶料瓶器 (经济型)

CODE	CAPACITY
------	----------

7060305	1-Pint
7060310	1-Quart
7060325	Half-Gallon

Store 'N' Pour Container (Economy)

胶料瓶器 (经济型)

CODE	CAPACITY
------	----------

7061105	1-Pint
7061110	1-Quart
7061125	Half-Gallon



Squeeze Dispenser

挤压分配器

CODE	CAPACITY (oz)
------	------------------

4126508-xx	8
4126512-xx	12
4126524-xx	24

*Available Colour

RD WH YE

When ordering RED add **CODE** suffix to item number
(example: 7060408-RD)



Stainless Steel Windproof Ashtray
全钢圆形烟灰缸

CODE	SIZE (ø x h cm)
7070501	6.3 x 6
7070502	9.5 x 10
7070601	10.0 x 7 Swivel Top



Prague Ashtray
烟灰缸



CODE	SIZE	
	(cm)	(inch)
7070701	h 3.6 Ø 14	1 1/2 5 1/2



Ashtray
烟灰缸



CODE	SIZE (ø cm)
7070401	10.7



2-Ply NCR "ORDER CHIT" Paper Booklet
可复写点菜簿

CODE	SIZE (l x h cm)
7031101	10 x 14



Stainless Steel Ashtray Slot
3洞钢烟灰缸

CODE	SIZE (ø cm)
7070201	10



Play Ashtray
烟灰缸



CODE	SIZE	
	(cm)	(inch)
7070801	h 3.5 Ø 10.6	1 1/2 4 1/4



Ashtray Nob Hill
烟灰缸



CODE	SIZE (ø cm)
7070301	10



Alum Tab Grabber
铝插单架

CODE	SIZE	
	(cm)	(inch)
7080112	30.48	12
7080118	45.72	18
7080124	60.96	24
7080136	91.44	38

BEVERAGE & BAR

Peanut Bowl 小碗



Viva Glass Bowl 小碗



CODE	SIZE		CAP
	(Ø x h mm)	(inch)	
7090512	120 x 50	4 3/4 x 2	33 cl - 11 1/4 oz
7090514	140 x 59	5 1/2 x 2 1/4	51 cl - 17 1/2 oz



Pompei Glass Bowl 小碗



CODE	SIZE	
	(Ø x h mm)	(inch)
7090706	60 x 30	2 1/4 x 1 1/4
7090708	80 x 41	3 1/4 x 1 1/2
7090710	105 x 53	4 1/4 x 2
7090712	120 x 60	4 3/4 x 2 1/4
7090714	140 x 70	5 1/2 x 2 3/4



Mr Chef Glass Bowl 小碗



CODE	SIZE		CAP
	(Ø x h mm)	(inch)	
7090809	88 x 37	3 1/2 x 1 1/2	8 cl - 2 3/4 oz
7090811	112 x 48	4 1/2 x 2	18 cl - 6 oz
7090814	140 x 61	5 1/2 x 2 1/2	36.5 cl - 12 1/4 oz



Aria Alfa Glass Bowl 小碗



CODE	SIZE		CAP
	(Ø x h mm)	(inch)	
7091001	133 x 70	2 3/4 x 5 1/4	25 cl - 8 1/2 oz



Aria Beta Glass Bowl 小碗



CODE	SIZE		CAP
	(Ø x h mm)	(inch)	
7091002	112 x 62	2 1/2 x 4 1/2	25 cl - 8 1/2 oz

Manual Plastic Ice Crusher Fixation by Air Valve 碎冰器



CODE	SIZE (cm)
7090401	





Oblong Plastic PVC Wire Basket 长方形的塑料篮

CODE	SIZE (l x w x h cm)
7100201	17 x 12 x 7.5
7100202	20 x 13 x 7.5
7100203	23 x 15 x 7.5
7100204	27 x 12 x 6.5



Round Plastic PVC Wire Basket 圆形的塑料篮

CODE	SIZE (l x w cm)
7100401	18 x 8.0
7100402	24 x 9.5



Round Bamboo Basket 圆形竹碗

CODE	SIZE (l cm)
7100605	11.43
7100606	13.97
7100607	16.51



Boat Plastic PVC Wire Basket 船形塑料篮

CODE	SIZE (l x w x h cm)
7100101	20 x 13.5 x 8



Rectangular Plastic Wire Basket 长方形的塑料篮

CODE	SIZE (l x w x h cm)
7100301	28 x 11 x 6



Oval Plastic Pvc Wire Basket 椭圆形的塑料篮

CODE	SIZE (l x w x h cm)
7100501	20 x 18 x 8
7100502	23 x 20 x 8



Oval Bamboo Basket 椭圆形竹篮

CODE	SIZE (l cm)
7100705	11.43
7100706	13.97
7100707	16.51



Polypropylene Round Basket 圓形籃

CODE	SIZE (ø x h cm)
7100819-xx	19 x 4.5

*Available Colour

■ RD ■ BK

When ordering RED add **CODE** suffix to item number
(example: 7100819-RD)



Polypropylene Oval Basket 橢圓形籃

CODE	SIZE (l x w x h cm)
7100920-xx	19.0 x 13.5 x 4.0
7100924-xx	24.0 x 15.0 x 4.0

*Available Colour

■ RD ■ BK

When ordering RED add **CODE** suffix to item number
(example: 7100920-RD)



Polypropylene Oval Basket 橢圓形籃

CODE	SIZE (l x w x h cm)
7101027-xx	27.0 x 17.5 x 3.0

*Available Colour

■ RD ■ BK

When ordering RED add **CODE** suffix to item number
(example: 7101027-RD)





Plastic Water Pitcher (Economy)
水壶 (经济型)

CAPACITY	
(oz)	
7120260	60



Covered Water Pitchers
水壶 (有盖) **CAMBRO**

CODE	CAPACITY
(oz)	
7120464	64



Pitcher
玻璃水壶



CODE	CAPACITY
(oz)	
7120634	34



Beer Pitcher
玻璃酒壶



CODE	CAPACITY
(oz)	
7120760	60



Water Pitchers
水壶



CAPACITY	
(oz)	
7120360	60



Water Pitchers
水壶

CODE	CAPACITY	COLOR
(oz)		
7122260-CL	60	CLEAR
7122260-SK	60	SMOKE



Wine Decanter
水壶



CODE	SIZE		CAPACITY
	(Ø x h mm)	(inch)	
7121440	62 x 115	2 1/2 x 4 1/2	30 cl - 10 1/4 oz
7121450	77 x 145	3 x 5 3/4	61 cl - 20 3/4 oz
7121460	93 x 186	3 3/4 x 7 1/4	116 cl - 39 1/4 oz



Glass Jug
水壶



CODE	SIZE	CAPACITY
(mm)		(inch)
7121500	h 30	11 3/4
		150 cl - 50 3/4 oz



Decanter
水壶



CODE	SIZE		CAPACITY
	(mm)	(inch)	
7122070	h 215 Ø 84	8 1/2 3 1/4	81 cl - 27 1/2 oz
7122060	h 264 Ø 92	10 1/2 3 1/2	119 cl - 40 1/4 oz



Decanter
水壶



CODE	SIZE		CAPACITY
	(mm)	(inch)	
7121971	h 165 Ø 68	6 1/2 2 3/4	28.5 cl - 9 5/8 oz
7121981	h 204 Ø 84	8 3 1/4	55 cl - 18 5/8 oz
7121901	h 255 Ø 104	10 4	108 cl - 36 1/2 oz



Beverage Decanters
饮料瓶



CODE	CAPACITY (lit)
7120802	0.25
7120805	0.5
7120810	1.0
7120815	1.5

Pour Spout Replacement Lid
饮料瓶盖

7120901



Decanter
水壶



CODE	SIZE		CAPACITY (oz)
	(l x w x h mm)	(inch)	
7122179	h 262 Ø 108	10 1/4 4 1/4	100 cl - 33 3/4 oz
7122169	h 235 Ø 84	9 1/4 3 1/4	50 cl - 17 oz
7122159	h 190 Ø 68	7 1/2 2 3/4	25 cl - 8 1/2 oz



Polycarbonate Pitcher
水壶



CODE	CAPACITY (lit / oz)	SIZE (Ø x h cm)
S143	1.4 / 49.4	10.9 x 23



Polycarbonate Ice Bucket
冰桶



CODE	CAPACITY (lit / oz)	SIZE (Ø x h cm)
S070	2.3 / 81.1	16.6 x 17.2



Shooter Glass

杯



CODE	SIZE (Ø x h mm)	CAPACITY
7122434	45 x 70	1.25 oz / 3.4 cl
7122457	50 x 90	2.0 oz / 5.7 cl



Shooter Glass Holder

杯架

CODE	TYPE
7122303	3 Holes
7122306	6 Holes
7122312	12 Holes



Glass Test Tube w/Rim

玻璃式管

CODE	SIZE (Ø x l mm)	CAPACITY ml
7122620	16 x 150	20
7122655	25 x 150	55
7122670	25 x 200	70



Test Tube Holder

式管架

CODE	TYPE
7122532	Fits 32 x Ø 25mm Test Tube



Test Tube Tray

式管架

ATHENA

CODE	SIZE (Ø cm)
7122712	26.8

Fits 12 pcs of small or large test tube with detachable handle, basket - Tray convertible



Test Tube Station, Reversilbe

式管架

ATHENA

CODE	SIZE (l x w x h cm)	FITS
7122812	25.8 x 8.6 x 10.0	12 pcs
7122824	48.5 x 8.6 x 10.0	24 pcs

Fits 12/24 pcs of small or large test tube

BEVERAGE & BAR

Round CT Non-Slip Tray **CAMBRO** 圆形防滑托盘



SPECIFICATIONS

Material	Fiberglass Layers + Polyester Resin + Non-Slip Rubber Surface
Surface Characteristic	Molded From Edge-To-Edge Non-Slip Rubber
Performance	Excellent
Stacking Lugs	Yes
Dishwasher Safe	Yes – Extensive
Chemical Resistance	Good
Drying Test	Excellent
Shock Resistance	Excellent
Break Resistance	Good
Scratch Resistance	Excellent
Stain Resistance	Good
Heat Resistance	-10° to +100°C‡ ‡ Not for use in heated carts.

CODE	SIZE	
	(l cm)	(inch)
4052011-xx	27.94	11
4052014-xx	35.56	14
4052016-xx	40.64	16

*Available Colour



When ordering BLACK add **CODE** suffix to item number (example: 4052011-BK)



Cotton Glass Cloth 棉毛巾

CODE	SIZE	
	(l x h cm)	(inch)
7110201	45.7 x 71.1	18 x 28



Round PT Non-Slip Tray **CAMBRO** 圆形防滑托盘



SPECIFICATIONS

Material	Polypropylene + Non-Slip Rubber Surface
Surface Characteristic	Non-Slip Rubber Surface
Performance	Good
Stacking Lugs	Yes
Dishwasher Safe	Yes – Minimal
Chemical Resistance	Good
Drying Test	Good
Shock Resistance	Good
Break Resistance	Good
Scratch Resistance	Good
Stain Resistance	Good
Heat Resistance	-10° to +80°C‡ ‡ Not for use in heated carts.

CODE	CAPACITY	
	(l cm)	(inch)
4052511-xx	27.94	11
4052514-xx	35.56	14
4052516-xx	40.64	16

*Available Colour



When ordering BLACK add **CODE** suffix to item number (example: 4052511-BK)



Square Cotton Face Towel (Extra Thick) 棉毛巾

CODE	SIZE
	(l x h cm)
7110301	30 x 30

Cotton Checked 棉毛巾

CODE	SIZE		
	(l x h cm)	(inch)	
7110101	45.7 x 71.1	18 x 28	12 pcs/pkt



GOURMET
STEEL

Stainless Steel Wine Bottle Holder
欧式不锈钢红酒架

CODE	SIZE (l cm)
7130201	20 x 9 x 22



Stainless Steel Wine Cooler
钢香槟桶

ATHENA®

CODE	CAPACITY (ltr)
7130402	4
7130401	6



Stainless Steel Double Wall Champagne Wine Cooler
钢双层香槟桶

ATHENA®

CODE	CAPACITY (ltr)
7130405	5



Stainless Steel Double Wall Wine Cooler (Mirror Finish)
钢双层香槟桶

ATHENA®

CODE	CAPACITY (ltr)
7130404	

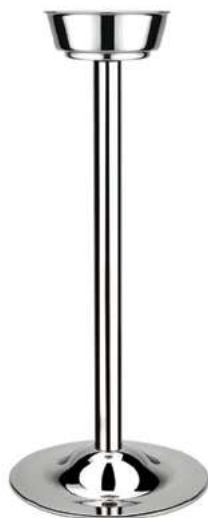

7130517

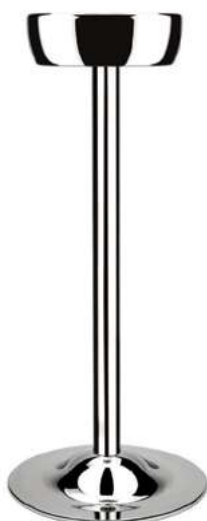

7130516

Stainless Steel Champagne Cooler Stand (Mirror Polish)
钢香槟桶架

ATHENA®

CODE	SIZE (Ø x h cm)	FITS
7130517	17 x 67.5	7130402 / 7130405 Champagne Bucket
7130516	20.5 x 68.5	7130401 Champagne Bucket

Stainless Steel "DELUXE" Champagne Bucket 钢香槟桶

CODE	SIZE
	(Ø x h cm)
7130901	19 x 23
7131001	19 x 23 Gold Handle

Stainless Steel "DELUXE" Champagne Bucket Stand 钢香槟桶架

CODE	SIZE
	(cm)
7131101	70



Stainless Steel "EUROPE" Style Champagne Bucket 钢欧式香槟桶

CODE	SIZE
	(Ø x h cm)
7130701	22 x 22

Stainless Steel "EUROPE" Style Champagne Bucket Stand 钢欧式香槟桶架

CODE	SIZE
	(Ø x h cm)
7130801	20 x 75
7130802	24.5 x 75 Extra Large Platform



Stainless Steel Champagne Bucket (2-Ring) 有两个圈形柄钢香槟桶

CODE	SIZE
	(Ø x h cm)
7130601	18.7 x 20





**Stainless Steel Insulated
“FRENCH STYLE” Champagne Bucket**
法式钢香槟桶

CODE	SIZE
	(Ø x h cm)
7131201	22 x 25

**Stainless Steel “FRENCH STYLE”
Champagne Bucket Stand (Mirror Finish)**
钢香槟桶架

CODE	SIZE
	(cm)
7131301	73



Wine Bucket
红酒桶

CAMBRO

CODE	SIZE
	(Ø x h cm)
7131401	20.3 x 23

Wine Bucket Stand
红酒桶架

CAMBRO

CODE	SIZE
7131501	





Stainless Steel 1-Pc Ice Scoop
不锈钢冰铲

CODE	SIZE (oz)
7170104	4



Polycarbonate Ice Scoop
胶冰铲

CAMBRO

CODE	SIZE (oz)
2170106	6
2170112	12
2170124	24
2170164	64



Ice Pick / Crusher (6-Prong)
木柄冰插

CODE	SIZE (cm)
7140201	19.68



Cast Aluminium Ice Scoop
铝制冰铲

CODE	SIZE (oz)
2170205	5
2170212	12
2170224	24
2170238	38
2170258	58



Ice Pick with Wooden Handle
木柄冰插

CODE	SIZE (cm)
7140101	20.32





Stainless Steel Double Wall Insulated Ice Bucket
钢双层冰桶

ATHENA®

CODE	CAPACITY (ltr)
7130403	1



Stainless Steel Insulated Ice Bucket (Mirror Finish)
钢冰桶

ATHENA®

CODE	CAPACITY (ltr)
7141501	1



Stainless Steel Ice Bucket (Satin Finish)
钢冰桶

ATHENA®

CODE	CAPACITY (ltr)
7140301	1.0



Stainless Steel Ice Bucket with Cover
有盖钢冰桶

CODE	SIZE (Ø x h cm)	CAPACITY (ltr)
7140401	12 x 13	1.0
7140402	15 x 16	2.0

Plastic Clear Ice Bucket
透明无盖胶冰桶



CODE	SIZE (Ø x h cm)	CODE	SIZE (Ø x h cm)	CODE	SIZE (Ø x h cm)	CODE	SIZE (Ø x h cm)
7141612	12.5 x 14.0	7141712	12.0 x 11.0	7141812	12.0 x 13.0	7141912	12.0 x 13.5



Clear Plastic Ice Bucket
透明胶冰桶

CODE	SIZE (Ø x h cm)
------	--------------------

7140801-BK 12 x 14



Glass Champagne Bucket
玻璃香槟桶

LSA
International

CODE	SIZE (Ø x h cm)
7142126	19 x 26



Stainless Steel Ice Tong (Satin Finish)
不锈钢冰块夹 *ATHENA*

	SIZE (cm)
7141017	17
7141015	15.5



Stainless Steel Molla Ice Cube Tong
不锈钢冰块夹

PIAZZA

	SIZE (cm)
2221318	18



Stainless Steel 1-Pc Ice Tong
全钢冰夹

CODE	SIZE (cm)
7141101	15.24



Glass Ice Bucket
玻璃冰桶

LSA
International

CODE	SIZE (Ø x h cm)
7142017	17 x 19



Glass Champagne Bucket
玻璃香槟桶

LSA
International

CODE	SIZE (Ø x h cm)
7142220	20 x 22.5



Stainless Steel Ice Cube Tong Bright
不锈钢冰块夹

PIAZZA

CODE	SIZE (cm)
2221617	16



Thick Stainless Steel 1-Pc Ice Tong
厚全钢冰夹

CODE	SIZE (cm)
7141217	17.78
7141222	22.86

Polycarbonate Huntington®

- Feature the elegant look and feel of glass without the high replacement costs.
- Made of virtually unbreakable polycarbonate
- Lightweight.
- Stacking lugs to prevent sticking
- Three sided drain bottom for easy washing and drying.

Withstands temperatures from -40°C to 99°C.



CODE	HT5CW	HT8CW	HT10CW	HT120CW	HT12CW	HT14CW	HT16CW	HT22CW
MAX DIAMETER	6,0 cm	6,8 cm	7,1 cm	7,6 cm	8,6 cm	8,3 cm	8,4 cm	8,9 cm
MAX HEIGHT	9,0 cm	11,3 cm	12,2 cm	12,8 cm	9,5 cm	12,4 cm	14 cm	17 cm
FULL SIZE CAMRACK®	49S318	36S418	36S434	25S434	25S418	25S434	25S534	25S638
CAPACITY TO RIM	5 oz	8 oz	10 oz	12 oz	12 oz	14 oz	16 oz	22 oz
CASE PACK	36	36	36	36	36	36	36	36

*Available Colour

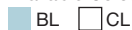

When ordering Blue add **CODE** suffix to item number
(example: HT5CW-BL)

Colorware Tumblers

- A classic value tumbler ideal for casual dining.
- Textured on the outside to resist scratching.
- Made of impact resistant SAN
- Interior stacking lugs for easy storing.
- Sani-Rim lip provides a sanitary drinking surface.



Withstands temperatures from -20°C to 85°C.



CODE	500P	800P	900P	950P	1200P	1600P
MAX DIAMETER	5,7 cm	6,7 cm	8,1 cm	7,0 cm	7,5 cm	8,0 cm
MAX HEIGHT	9,2 cm	10,2 cm	8,25 cm	11,1 cm	13,2 cm	14,6 cm
FULL SIZE CAMRACK®	49S318	36S418	25S318	36S418	25S434	25S534
CAPACITY TO RIM	5 oz	8 oz	9 oz	9.5 oz	12 oz	16 oz
CASE PACK	72	72	72	72	72	72

*Available Colour



Laguna Tumblers

- Hammered texture hides water spots and scratches.
- Made of impact resistant SAN.
- Lightweight and easy to carry.

Withstands temperatures from -20°C to 85°C.



CODE	LT6	LT8	LT10	LT12	LT14	LT16	LT22
MAX DIAMETER	6,3 cm	6,9 cm	7,4 cm	7,9 cm	8,3 cm	8,4 cm	9,3 cm
MAX HEIGHT	10,7 cm	10,9 cm	12,1 cm	12,7 cm	13,1 cm	14 cm	15,4 cm
FULL SIZE CAMRACK®	36S418	36S418	36S434	25S434	25S434	25S534	16S534
CAPACITY TO RIM	6 oz	8 oz	10 oz	12 oz	14 oz	16 oz	22 oz
CASE PACK	36	36	36	36	36	36	36

*Available Colour

GR CL

When ordering Green add **CODE** suffix to item number (example: LT6-GR)



Del Mar Tumblers

- Crackled glass look features the lightweight handling of plastic.
- Thick sturdy base and rolled rim edge for added stability.
- Made of impact resistant SAN plastic.

Withstands temperatures from -20°C to 85°C.



CODE	D8	D12	D14	D16
MAX DIAMETER	6,7 cm	7,5 cm	8,3 cm	7,8 cm
MAX HEIGHT	10,6 cm	12,0 cm	8,3 cm	15,1 cm
FULL SIZE CAMRACK®	36S418	25S434	25S318	25S534
CAPACITY TO RIM	8 oz	12 oz	14 oz	16 oz
CASE PACK	36	36	36	36

*Available Colour

RD CL BL AB

When ordering Clear add **CODE** suffix to item number (example: D8-CL)

Polycarbonate Aliso® Barware, Goblets and Dessert Glass

Aliso Barware replicates the look, heft and clarity of glass with shatterproof polycarbonate. The smooth seamless appearance makes Aliso Barware a stylish choice for casual dining, outdoor events or for poolside service.

- Barware items have large, heavy bases for stability.
- Bases designed for fast draining and complete drying.
- Chill or frost barware without concerns of thermal shock damage.

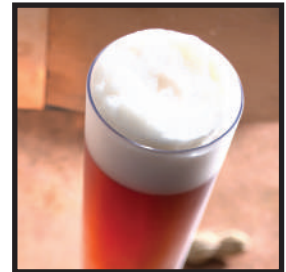

CODE	BWM10CW	BWW10CW	BWP14CW	BWB16CW	GB850CW	GB1200CW
DESCRIPTION	Martini	Wine	Pilsner	Beer Mug	Goblet	Goblet
MAX DIAMETER	12,2 cm	7,5 cm	8,3 cm	12,1 cm	7 cm	7 cm
MAX HEIGHT	17,5 cm	17,1 cm	24,3 cm	15,9 cm	15,9 cm	19,4 cm
FULL SIZE CAMRACK®	9S638	25S638	25S958	16S638	36S534	36S738
CAPACITY TO RIM	10 oz	10 oz	14 oz 16 oz	8,5 oz	12 oz	
CASE PACK	12	24	24	12	24	24

- Look Like Crystal
- Unbreakable
- Dishwasher Safe
- Polycarbonate



CODE	S035	S037	S038	S039	S046
DESCRIPTION	Sherry	White Wine	Red Wine	Red Wine	Goblet
DIAMETER	6.5 cm	7.5 cm	8.2 cm	8.8 cm	8.1 cm
HEIGHT	14.6 cm	17.5 cm	19 cm	20.5 cm	16.4 cm
CAPACITY	130 ml / 4.5 oz	225 ml / 7.9 oz	290 ml / 10.2 oz	365 ml / 12.8 oz	345 ml / 12.1 oz



CODE	S049	S055	S052	S057	S058
DESCRIPTION	Champagne Flute	Martini	Margarita	Hurricane	Hurricane
DIAMETER	7 cm	13.5 cm	11.7 cm	7.8 cm	8.8 cm
HEIGHT	24.4 cm	17.4 cm	17 cm	20.5 cm	19.3 cm
CAPACITY	170 ml / 5.9 oz	295 ml / 10.4 oz	315 ml / 11.1 oz	320 ml / 11.2 oz	430 ml / 15.1 oz



CODE	S059	S153	S051	S084	S085
DESCRIPTION	Hurricane	Pina Colada	Pina Colada	Pilsner	Pilsner
DIAMETER	8.1 cm	8.6 cm	8.9 cm	7.6 cm	8.6 cm
HEIGHT	19 cm	18.1 cm	9 cm	16 cm	17.3 cm
CAPACITY	375 ml / 13.2 oz	445 ml / 15.6 oz	385 ml / 13.5 oz	285 ml / 10 oz	430 ml / 15.1 oz



CODE	S048	S178	S100	S099	S094
DESCRIPTION	Pilsner	Beer Mug	Mug	Mug	Mug
DIAMETER	8.3 cm	7.8 cm	7.7 cm	8.8 cm	7.1 cm
HEIGHT	23.9 cm	16.2 cm	11.3 cm	12.4 cm	14.8 cm
CAPACITY	415 ml / 14.6 oz	580 ml / 20 oz	265 ml / 9.3 oz	380 ml / 13.4 oz	280 ml / 9.8 oz



CODE	S006	S007	S001	S002	S003
DESCRIPTION	Rock	Rock	Rock	Highball	Highball
DIAMETER	8 cm	8.5 cm	6.5 cm	6.5 cm	6.5 cm
HEIGHT	9 cm	10 cm	8 cm	11.7 cm	14.1 cm
CAPACITY	290 ml / 10.2 oz	370 ml / 13 oz	160 ml / 5.6 oz	260 ml / 9.1 oz	325 ml / 11.4 oz



CODE	S004	S010	S080	S081	S082
DESCRIPTION	Tall	Tall	Rock	Highball	Tall
DIAMETER	6.5 cm	7 cm	8.3 cm	9.5 cm	8.4 cm
HEIGHT	15.5 cm	17 cm	9.9 cm	10.3 cm	16.1 cm
CAPACITY	355 ml / 12.5 oz	455 ml / 16 oz	300 ml / 10.5 oz	395 ml / 13.9 oz	510 ml / 17.9 oz



CODE	S083	S017	S018	S019	S021
DESCRIPTION	X-Tall	Rock	Rock	Highball	Tall
DIAMETER	8.8 cm	8.6 cm	9.1 cm	9.7 cm	8.2 cm
HEIGHT	19.5 cm	8.3 cm	8.5 cm	9.8 cm	14.8 cm
CAPACITY	655 ml / 23.1 oz	255 ml / 8.9 oz	290 ml / 10.2 oz	390 ml / 13.7 oz	415 ml / 14.6 oz



CODE	7190112	7190213	7190309	7190411	7190510
DESCRIPTION	Bistro	Roman	Rock	Barware	Rock
DIAMETER	7 cm	8.5 cm	8.3 cm	8 cm	8.5 cm
HEIGHT	14.5 cm	12.2 cm	9 cm	11.7 cm	9.4 cm
CAPACITY	12 oz	13 oz	9 oz	11 oz	10 oz



CODE	7190612	7190710	7190813	7190913	7191011
DESCRIPTION	Ocean	Swirl	Swirl	Square	Ocean
DIAMETER	8 cm	7.7 cm	8.1 cm	8.5 cm	7.5 cm
HEIGHT	13.5 cm	8.7 cm	13.7 cm	9.6 cm	12.3 cm
CAPACITY	12 oz	10 oz	13 oz	13 oz	11 oz



CODE	7191109	7191212	7191321	7191419	7191509
DESCRIPTION	Ocean	Tumbler	Tumbler	Tumbler	Tumbler
DIAMETER	8 cm	8.5 cm	9 cm	8.7 cm	8.7 cm
HEIGHT	9.1 cm	10.5 cm	18 cm	17.5 cm	9.5 cm
CAPACITY	9 oz	12 oz	21.5 oz	19 oz	9.5 oz

BEVERAGE & BAR



CODE	7191603	7191714	7191816	7191912	7192009
DESCRIPTION	Tumbler	Tumbler	Tumbler	Tumbler	Tumbler
DIAMETER	6.3 cm	9 cm	8.5 cm	8 cm	7.6 cm
HEIGHT	6.7 cm	9.2 cm	13.3 cm	11.4 cm	10 cm
CAPACITY	3.5 oz	14.5 oz	16 oz	12 oz	9.5 oz



CODE	7192107	7192215	7192311	7192413	7192507
DESCRIPTION	Tumbler	Tumbler	Tumbler	Tumbler	Tumbler
DIAMETER	7.4 cm	8.5 cm	7.9 cm	9.1 cm	7.5 cm
HEIGHT	7.8 cm	12 cm	11.8 cm	9.4 cm	7.9 cm
CAPACITY	7 oz	15.2 oz	11 oz	13.5 oz	7.1 oz



CODE	7192609	7192710	7192817	7193008	7193109
DESCRIPTION	V-Shape	Checked Base	Checked Base	Tumbler	Tumbler
DIAMETER	9.7 cm	7.2 cm	7.8 cm	6.7 cm	6.8 cm
HEIGHT	11.7 cm	12.2 cm	15.5 cm	10 cm	12.1 cm



CODE	7193214	7193313	7193409	7193510	7193612
DESCRIPTION	Footed	Footed	Rock	Rock	Rock
DIAMETER	9 cm	7 cm	9.5 cm	9.1 cm	8.8 cm
HEIGHT	19.5 cm	21.5 cm	9 cm	10.4 cm	12.5 cm
CAPACITY	14.5 oz	13.5 oz	9.5 oz	10 oz	12 oz



CODE	7193716
DESCRIPTION	Rock
DIAMETER	9.6 cm
HEIGHT	14.5 cm
CAPACITY	16 oz





CODE	7200108	7200212	7200312	7200414	7200515
DESCRIPTION	Tumbler	Tumbler	Quantum	Quantum	Quantum
DIAMETER	6.6 cm	7.25 cm	8.25 cm	7.4 cm	7.4 cm
HEIGHT	9.9 cm	12.6 cm	9.4 cm	13.8 cm	13.8 cm
CAPACITY	8 oz	12 oz	12.5 oz	14.5 oz	14.5 oz



CODE	7200615	7200714	7200814	7200914	7201012
DESCRIPTION	Hi-Ball	Tumbler	Hi-Ball	Hi-Ball	Tumbler
DIAMETER	7.3 cm	8.2 cm	8.4 cm	7.8 cm	7.9 cm
HEIGHT	18.3 cm	13 cm	12.1 cm	16 cm	12.7 cm
CAPACITY	14 oz	12 oz	12 oz	13 oz	12 oz



CODE	7201114	7201212	7201301	7201412	7201613
DESCRIPTION	Hi-Ball	Hi-Ball	Pilsner	Hi-Ball	Tumbler
DIAMETER	7.4 cm	7.1 cm	8.8 cm	8 cm	8.9 cm
HEIGHT	14.5 cm	14.5 cm	15.4 cm	13.5 cm	19 cm
CAPACITY	14 oz	12 oz	19 oz	12 oz	14 oz

Melamine Tumbler



CODE	7201706-XX	7201710-XX
DESCRIPTION	Tumbler	Tumbler
DIAMETER	7.5 cm	8.8 cm
HEIGHT	7.6 cm	9.0 cm
CAPACITY	6 oz	10 oz

*Available Color ■ IVGR ■ IVCO ■ IVCR ■ IVCP ■ IVFB

When ordering White add **CODE** suffix to item number (example: 7201706-WH)



Milk Shake Mixer 奶昔机



CODE	SIZE (l x w x h)	
7150201	17.14 x 16.51 x 52	Single
7150301	31.75 x 22.86 x 52	Triple

3 speed toggle switch for quick and easy access. Automatically activate when the cup is placed in position & stop when removed. Stainless steel agitator cuts through hard ice-cream. Perfect for milk shakes, smoothies, bar cocktails, eggs, butters, ice cream drinks.

Voltage: 240V, 50/60Hz **Power:** 1/3 hp ; 900 watts



Milk Shake Mixer - Single / Double 奶昔机



CODE	SIZE (l x w x h cm)	SPEC
7152101	15.0 x 19.5 x 48.5	Power Watt 100 - Hp 0,14; F+N; r.p.m. 14000;
7152102	30.0 x 19.5 x 48.5	Power Watt 100+100Hp 0,14+0,14

A complete line of drink mixers with a modern soft design. Designed to commercial use, they meet all European and North-American safety requirements.

- White or chrome head, aluminium stem and die casting base for a perfect stability, no edges or seams for easier cleaning.
- Countertop (1 or 2 cups) or wall unit versions available.
- Transparent 550 cc Tritan cup or stainless steel cup on request.
- 900 cc stainless steel cup on 120 W version.
- Powerful ventilated motor for a longer life.
- Spindle with three aluminium and Stainless Steel agitators for preparing cocktails and drinks, or with a special round agitator for frozen coffees or for creamier results.
- Safety microswitch on the cup support (optional for non UE countries).
- Speed control on request.

Voltage: 240V, 50/60Hz



Rio Bar Blender 搅拌机



CODE	SIZE (l x w x h)	CAPACITY (oz)
7150401	20.3 x 16.51 x 40.64	44 Polycarbonate
7150501	20.3 x 16.51 x 40.64	32 Stainless Steel

2 speed control with pulse option. 4 stainless steel cutting and mixing blades blend perfectly with ice. Durable 32 oz stainless steel container is made with measurement marks. Break resistant 44 oz polycarbonate container is able to snack up for storage

Voltage: 240V, 50/60Hz **Power:** 3/4 hp ; 450 watts

“TEMPEST” High Speed Bar Blender 搅拌机



CODE	SIZE (l x w x h)	CAPACITY	POWER
7150701	20.3 x 17.78 x 45.72	64 oz / 1.8 L	880 watt

Wave Action® System for Smooth Results with No Ice Chunks
2 Speeds, Jump Cycle, Pulse Button, and Timer for Precision Blending
Powerful 3 Hp Motor Satisfies the Demands of the Busiest Bars
All-Metal Drive Coupling and Stainless Steel Blades
Stackable 64 oz. / 1.8 L Container

Voltage: 240V, 50/60 Hz **Power:** 3 hp ; 880 watts



Summit High Performace One Touch Bar Blender (Silent Shield) 搅拌机



CODE	SIZE (l x w x h)	CAPACITY
7150801	30.48 x 22.86 x 48.26	64 oz / 1.8 L

Hundreds of programmed cycles with pulse provides unlimited options whe preparing drinks. Auto blend stops the blender when reached the perfect consistency. Dual fans automatically keep motor cool in-between blends. Jar pad sensor turns off motor when container is not in place. Easy to read lcd display allows easy use and programmability. Quiet shiled sound enclosure reduces blender noise. Comes with 64 oz stackable polycarbonate container.

Voltage: 240V, 50/60 Hz **Power:** 3 hp ; 880 watts



“TOUCH N GO 2 ” Bar Blender 搅拌机



CODE	SIZE (l x w x h cm)	CAPACITY
7151301	23.5 x 26.7 x 49.2	0.9 L / 32 oz

- On-counter mounted model
- 34 programs and pulse switch
- 0.9 Ltr high-impact jug and Advance® blade
- ~2 peak output HP* motor
- Low profile and sound reducing cover

Voltage: 230V, 50 / 60Hz. **Power:** 2 amp; 1075-1200 Watts



“TOUCH N GO 2 ” The Quite One Bar Blender 搅拌机



CODE	SIZE (l x w x h cm)	CAPACITY
7151302	21.6 x 29.5 x 45.7	1.4 L / 47 oz

- On-Counter 1.4 litre blender
- Up to 4 times quieter than the competition
- Ideal for front-of-the-house-environment
- Powerful ~3 peak output HP* motor
- 6 program buttons with 34 optimised programs

Voltage: 230V, 50 / 60Hz. **Power:** 10 amp; 1300 - 1500 Watts





Advance Vita-Mix Bar Blender 搅拌机



CODE	SIZE (l x w x h cm)	CAPACITY
7152201	20.3 x 22.9 x 44.9	0.9 L / 32 oz

Smart Product Design

- 6 optimized programs and automatic shut-off means you can turn it on, walk away, and blend consistently-smooth beverages
- Pulse control quickly refreshes drinks for efficiency
- The Advance® container has a longer life, with improved pourability and extended blade life saving you time and money
- Advanced motor is designed to resist overheating when blending extra-thick ingredients resulting in enhanced reliability during peak hours of operation

Voltage: 230V, 50 / 60Hz **Power:** 2 hp ; 1000-1200 Watts



Advance Vita-mix Bar Blender 搅拌机



CODE	SIZE (l x w x h cm)	CAPACITY
8030148	22 x 18.5 x 44	48 - oz / 1.4 - L

- 2-Speed, Complete with 1.4 litre standard container
- 37,000 rpm motor speed
- Blends between 120ml and 1.4 litres
- Durable polycarbonate container
- Metal-to-metal driver contact for maximum durability

Voltage: 240V, 50 / 60Hz **Power:** 2 hp ; 750 - 800 Watts



Upright Bar Glass Washer 电动洗杯机



CODE	SIZE (l x w x h cm)
7150101	41 x 28 x 33

The compact Bar Maid "SS" series Submersible is the ultimate combination of quality, reliability and versatility. The partially submerged sealed motor helps to maintain warm water temperature. Uses optional accessory brushes to clean almost any size or shape of glassware. Inexpensive to buy and built to stay that way.

Voltage: 220/230V-50Hz/60Hz



Ice Cube Crusher 碎冰机



CODE	SIZE (l x w x h)
7151401	47.4 x 23.6 x 35.3

The ice crushed (fine or coarse). All removable parts can be put in a dishwasher or easily cleaned with hot soapy water. Aluminum casting and stainless steel construction polycarbonate ice cubes tank high capacity ice cubes tank (1.2kg of ice cubes)

Citrus Juicer Extractor with Lever Cover

榨果汁机



CODE	SIZE (l x w x h)
8030300	21 x 30 x 38.5

- POWER: 150W, 230V 50 / 60Hz
- Imposing, efficient, heavy-duty juicer
- Anodized aluminium construction
- AISI 304 stainless steel bowl and cover
- Powerful ventilated motor with gear drive
- Easily removable and dishwasher-safe reamers
- Safety microswitch on the reamer



Citrus Juicer

榨果汁机



CODE	SIZE (l x w x h)
8030400	21 x 30 x 38.5

- POWER: 150W, 230V 50 / 60Hz
- Imposing, efficient, heavy-duty juicer
- Anodized aluminium construction
- AISI 304 stainless steel bowl and cover
- Powerful ventilated motor with gear drive
- Easily removable and dishwasher-safe reamers
- Safety microswitch on the reamer



Ice Crusher

碎冰机



CODE	SIZE (l x w x h)
8040900	36.5 x 21 x 29.5

- POWER: 350W, 230V / 50 - 60Hz
- Triton allows to crush ice in different sizes by adjusting the blade:
- finely crushed ice for the traditional Italian granitas
- flakes for frozen cocktails or to serve or display cold dishes



Juice Extracting Machine

榨果汁机



	SIZE (l x w x h)	POWER watt	TYPE
7151701	23 x 42 x 50	700	J 80
7151702	23 x 42 x 59	1000	J 100

Table top model delivered with stainless steel motor base. Centrifugal juicer with pulp extraction and automatic feed mechanism. Delivered with: polycarbonate lid 2.5 mm grating disc and filter basket bowl with anti-drip spout 6.5 qt waste container

Power: 1.25 Hp - Single phase
Speed: 3000rpm





Centrifugal Juice Extractor No.50

榨果汁机



CODE	SIZE (l x w x h)
7151901	47 x 26 x 45

Up to 25 gallons (100 liters) of apple juice per hour. Extra wide feeding chute: 3"/79.5mm. Easy and safe locking and unlocking system with a simple handle in front of the cover. Easy assembly and disassembly of the cover, filter-basket and bowl. Motor braking when opening. 800w heavy duty motor, particularly silent.

Voltage: 220-240V, 50 / 60Hz
Power: 800W
Speed: 3000rpm.



Centrifugal Juice Extractor No.28

榨果汁机



CODE	SIZE (l x w x h)	TYPE
7151801	33 x 45.6 x 51	No 28

For all fruits and vegetables (citrus fruits must be peeled) continuous juice production by centrifugal action and automatic pulp ejection. High output: more than 1 liter / minute. Wide circular feeding hole: 2.7"(68mm diameter). Patented locking-unlocking system with special lever. Motor braking when opening. 800w silent heavy duty motor.

Voltage: 220-240V, 50 / 60Hz.
Power: 1300W
Speed: 3000rpm.



Centrifugal Juice Extractor No.68

专业榨果汁机



CODE	SIZE (l x w x h)
7152001	48 x 32 x 58

The Miracle edition offers a high efficiency and is adapted to intensive use. Perfect filtration for a high quality juice : large basket with very fine sieve (0.5 mm / 0.02"). Full stainless steel food-zone (no aluminum). Wide feeding chute (79,5 mm diameter): no need to cut fruits and vegetables. New generation patented Ezy-clean™ system II: removable bowl, basket and cover (no tool needed). Extremely sturdy: shifter all in metal. Spout height: 228 mm (9"), to make juice in a glass or in a jug. Exceptional output: 140 l/h.

Voltage: 220 - 240V, 50 / 60Hz
Power: 1300W
Speed: 3000rpm.



Food Service & Buffet Ware





REVOLUTION 2

COLLECTION



Seduction & innovation

REVOLUTION 2 is the result of five years of research and experience for a revisited version of our induction buffet concept.

A style that has been modernized with a new delicately engraved handle, our quality guarantee.

A new colour, Touareg blue, whose unparalleled elegance perfectly matches the other colours in the collection.

A new design with a perfectly flat bottom for an even higher technical performance.



CREATE
YOUR OWN
BUFFET





Whatever the theme or the place, REVOLUTION 2 brings you solutions for an audacious and appetizing service.

REVOLUTION 2

COLLECTION

MAINTAINS DESIRED TEMPERATURE
WITH REGULATED WARMING SYSTEM



Shape	Size	Capacity	Ref. Model	Lid Colors		
	Ø 16.4 cm Ø 6 ½ inch H. 10.7 cm H. 4 ¼ inch	0.80 L 28 ¼ oz	RV21016BI			
	Ø 19 cm Ø 7 ½ inch H. 12.5 cm H. 5 inch	1.20 L 42 ¼ oz	RV21018BI	649802	649801	649803
	Ø 22 cm Ø 8 ¾ inch H. 14 cm H. 5 ½ inch	2.40 L 84 ¾ oz	RV21022BI	649816	649815	649817
	Ø 26 cm Ø 10 ¼ inch H. 14.5 cm H. 5 ¾ inch	3.40 L 120 oz	RV21025BI	649855	649853	649852
	Ø 28 cm Ø 11 inch H. 13.5 cm H. 5 ¼ inch	3.60 L 127 oz	RV21428BI	649863	649861	

LID COLOURS



Touareg blue









Satin black



Pepper red

ADD-ONS AND ACCESSORIES

Shape	Size	Capacity	Ref. Model	L id Colors		
	Ø 26.5 cm Ø 10 ½ inch H. 6.5 cm H. 2 ½ inch	1.50 L 53 oz	RV1025BM			Stainless Steel
			646792			
	Ø 26.5 cm Ø 10 ½ inch H. 6.5 cm H. 2 ½ inch	-	RV1025VP	647551		
	19.7 x 10.4 x 3.8 cm 7 ¾ x 4 x 1 ½ inch	-	RV1620	644293		
	12 x 6 x 8 cm 4 ¾ x 2 ¼ x 3 ¼ inch	-	RVPC1012	645051		
	30.5 x 23 x 37.5 cm 12 x 9 x 14 ¾ inch	-	RVPC1131	644282		

Please contact us for more information on Revol Revolution 2 series

FORT ENAMEL CAST IRON

ATHENA IS PROUD TO LAUNCH HER FIRST RANGE OF ENAMEL CAST IRON PANS AND POTS – FORT – WHICH ANSWERED TO THE NEEDS OF COLOURS AND PERFORMANCE REQUIRED BY THE BUFFET TABLES AND KITCHENS. EIGHT IRRESISTIBLE COLOURS IN SIXTEEN FUNCTIONAL SHAPES ARE AVAILABLE AT YOUR CHOICE FOR THE PHASE ONE. MORE DESIGNS WILL BE LAUNCHED GRADUALLY ACCORDING TO TRENDS AND NEEDS OF THE MARKETS.







FORT

ATHENA ENAMEL CAST IRON PANS AND POTS BRING STYLE AND COLORS TO BUFFET. THEY ARE EXCELLENT FOR HOT FOOD DISPLAY. THEY WORK ON INDUCTION, HOT PLATE AND GAS STATION AT A LOW ENERGY CONSUMPTION LEVEL AND KEEP FOOD HOT AND FRESH.

ROUND MINI POT



CODE: 1260110
CI-10RP6/ Ø100×60(H)MM 0.3L

SAUCE PAN



CODE: 1260216
CI-16SP10/ Ø160×92(H)MM 1.3L

RECTANGULAR ROASTING DISH



CODE: 1260530
CI-30TD22/ 300×220×55(H)MM 2.6L

GRILL PAN



CODE: 1260628
CI-28GP28/ 280×280×50(H)MM 1.8L

WOK



CODE: 1260728
CI-28WK8/ Ø280×78(H)MM 1.8L



CODE: 1260736
CI-36WK10/ Ø360×100(H)MM 2.2L

COLOUR CHOICES:

RED=RED 

ORANGE=ORA 

CYAN=CYN 

ASH=ASH 

WHEN ORDERING RED COLOUR ADD CODE SUFFIX TO ITEM NO. (EXAMPLE: 1261016 - RED)



ROUND POT



CODE: 1260824
CI-24RP12/ Ø240×120(H)MM 3.8L

FRYPAN DOUBLE HANDLE



CODE: 1260930
CI-30DFP7/ Ø300×70(H)MM 3.3L

OVAL POT



CODE: 1261030
CI-30VP15/ 300×225×143(H)MM 5.3L

LID STAND



CODE: 1261116 BU-41/ 160×153×198(H)MM

REECE WOODEN STAND FOR MINI POTS



CODE: 4160733 RI-13.486180.58/ 486×180×58(H)MM

BLACK=BLK 

COBALT=CBT 

CREAM=CRM 

YELLOW=YEL 



REGAL



DELUXE INDUCTION CHAFING DISH

REGAL IS THE FACE-LIFTED VERSION OF PRINCE WHICH FEATURES A BIG TEMPERED GLASS LID PROVIDING A PANORAMIC VIEW OF FOOD AIMING TO RAISE APPETITE. IT HAS A CLEAN AND SLIM SILHOUETTE AND TOP QUALITY DEFINED BY THE PATENTED HYDRAULIC HINGE AND HEAVY GAUGE STAINLESS STEEL BODY.

SMOOTH OPENING, AUTO STOP, SILENT CLOSING. GOOD FOR INDUCTION, ELECTRIC AND FUEL.

- 18/10 STAINLESS STEEL BODY
- WITH CAPSULED BOTTOM COMPATIBLE FOR INDUCTION, CHAFER FUEL AND ELECTRIC HEATER
- EU1935/2004 FOOD SAFE STANDARD CONFORMED

DETACHABLE LID
– FOR QUICK & EASY CLEANING

LID POSITION
– OPENS UP TO MAXIMUM 90°
– STAYS OPEN AT APPROX. 75°
– INITIATE TO CLOSE BY PRESSING DOWN GENTLY
– LID FALLS & CLOSSES AUTOMATICALLY & SILENTLY

NOISE STOPPER
– EASES NOISE OF CLOSING LID

WATER RETURN SYSTEM
– CONDENSATION FLOWS BACK TO WATER PAN INSTEAD OF FOOD

CONVENIENT NOTCH
– CHANGING FOOD PAN EASILY

CAPSULED BOTTOM
– MULTI-LAYER BOTTOM FOR FAST & EVEN HEATING

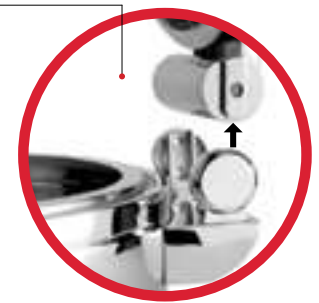

HYDRAULIC HINGE
– FOR SMOOTH OPENING & CLOSING OF LID



REGAL
ROUND

ROUND CHAFING DISH
OPTIONAL 36CM FOOD PAN 6.1 LTR.

W/ GLASS LID 



4015103

DIMENSIONS

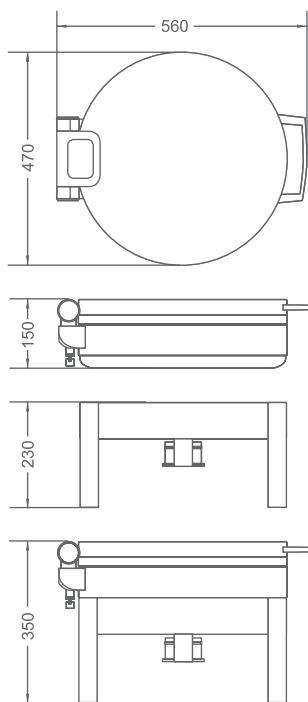

4015103 WITH STAND



STACKABLE DESIGN

- MATCHING STAND 4015104

OPTIONAL ACCESSORIES:

CHROME-NICKEL STAINLESS STEEL
EU 1935/2004 FOOD SAFE
STANDARD CONFORMED



4012436
36CM ROUND FOOD PAN 6.1 LTR.



4012536
DIVIDED 36CM ROUND FOOD PAN 5.8 LTR.

VITRIFIED NON-POROUS
PORCELAIN FOOD PAN
EU 1935/2004 FOOD SAFE
STANDARD CONFORMED



4012736
36CM ROUND FOOD PAN 6.1 LTR.



4012836
DIVIDED 36CM ROUND FOOD PAN 5.8 LTR.

CHOICE OF HEATING
ELEMENTS :

-  EXTERNAL INDUCTION DEVICE
-  FUEL
-  INDUCTION UNIT GO WITH STAND
-  EXTERNAL ELECTRICAL DEVICE

REGAL
ROUND - SMALL

ROUND CHAFING DISH
OPTIONAL 28CM FOOD PAN 4.0 LTR.

W/ GLASS LID



4015203

DIMENSIONS

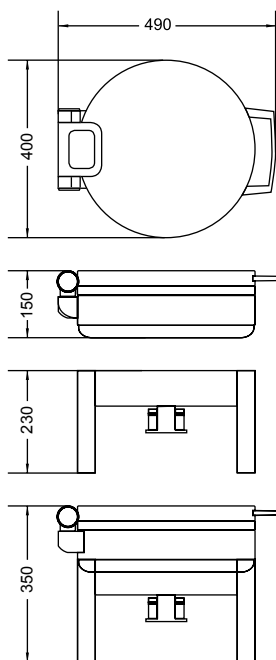

STACKABLE DESIGN

- MATCHING STAND 4015204

OPTIONAL ACCESSORIES:

CHROME-NICKEL STAINLESS STEEL
EU 1935/2004 FOOD SAFE
STANDARD CONFORMED



4012428
28CM ROUND FOOD PAN 4.0 LTR.

VITRIFIED NON-POROUS
PORCELAIN FOOD PAN
EU 1935/2004 FOOD SAFE
STANDARD CONFORMED



4012728
28CM ROUND FOOD PAN 4.0 LTR.



4012828
DIVIDED 28CM ROUND FOOD PAN 2.5 LTR.

CHOICE OF HEATING

ELEMENTS :



EXTERNAL INDUCTION
DEVICE



FUEL



INDUCTION UNIT
GO WITH STAND



EXTERNAL ELECTRICAL
DEVICE

REGAL
SOUP STATION

SOUP STATION
W/ 11 LTR. SOUP BUCKET

W/ GLASS LID 



4015303

DIMENSIONS

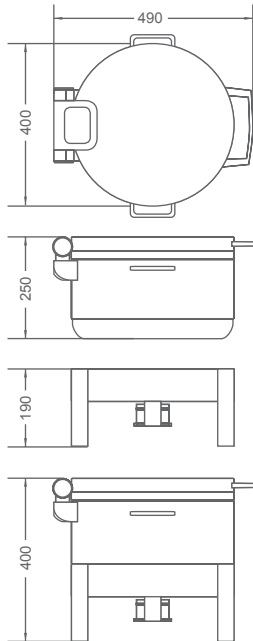

4015303 WITH STAND



- MATCHING STAND 4015304



CHOICE OF HEATING
ELEMENTS :

-  EXTERNAL INDUCTION DEVICE
-  FUEL
-  INDUCTION UNIT GO WITH STAND
-  EXTERNAL ELECTRICAL DEVICE

REGAL
GN 1 / 1

OBLONG CHAFING DISH
OPTIONAL GN 1/1 FOOD PAN 9.0 LTR.

w/ GLASS LID 



DIMENSION

4015403

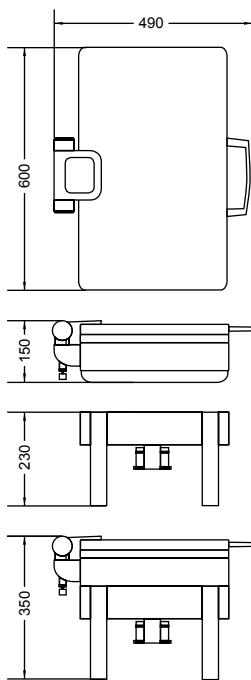

4015403 WITH STAND



STACKABLE DESIGN

- MATCHING STAND 4015404

OPTIONAL ACCESSORIES:

CHROME-NICKEL STAINLESS STEEL
EU 1935/2004 FOOD SAFE
STANDARD CONFORMED



1150206
GN 1/1 FOOD PAN 9.0 LTR.



1150306
GN 1/2 FOOD PAN 4.3 LTR.

VITRIFIED NON-POROUS
PORCELAIN FOOD PAN
EU 1935/2004 FOOD SAFE
STANDARD CONFORMED



4012611
GN 1/1 FOOD PAN 9.0 LTR.



4012612
GN 1/2 FOOD PAN 4.3 LTR.

CHOICE OF HEATING
ELEMENTS :



REGAL
GN 2/3

OBLONG CHAFING DISH
OPTIONAL GN 2/3 FOOD PAN 5.9 LTR.

w/ GLASS LID 



4015503

DIMENSIONS

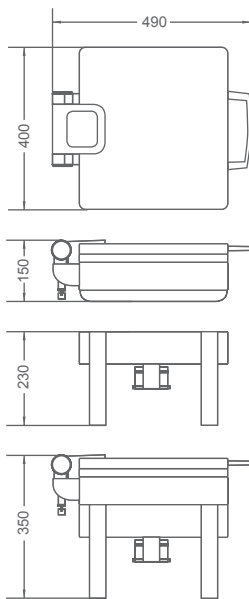

4015503 WITH STAND



STACKABLE DESIGN

- MATCHING STAND 4015504

OPTIONAL ACCESSORIES:

CHROME-NICKEL STAINLESS STEEL
EU 1935/2004 FOOD SAFE
STANDARD CONFORMED



1150406
GN 2/3 FOOD PAN 5.9 LTR.



1150506
GN 1/3 FOOD PAN 2.7 LTR.

VITRIFIED NON-POROUS
PORCELAIN FOOD PAN
EU 1935/2004 FOOD SAFE
STANDARD CONFORMED



4012623
GN 2/3 FOOD PAN 5.9 LTR.



4014523
DIVIDED GN 2/3 FOOD PAN 5.4 LTR.

CHOICE OF HEATING

ELEMENTS :



EXTERNAL INDUCTION
DEVICE



FUEL



INDUCTION UNIT
GO WITH STAND



EXTERNAL ELECTRICAL
DEVICE

REGAL
GN 1/2

OBLONG CHAFING DISH
OPTIONAL GN 1/2 FOOD PAN 4.3 LTR.

W/ GLASS LID 



4015603

DIMENSIONS

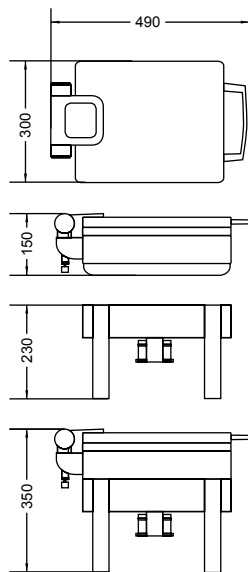

4015603 WITH STAND



STACKABLE DESIGN

- MATCHING STAND 4015604

OPTIONAL ACCESSORIES:

CHROME-NICKEL STAINLESS STEEL
EU 1935/2004 FOOD SAFE
STANDARD CONFORMED



1150306
GN 1/2 FOOD PAN 4.3 LTR.

VITRIFIED NON-POROUS
PORCELAIN FOOD PAN
EU 1935/2004 FOOD SAFE
STANDARD CONFORMED



4012612
GN 1/2 FOOD PAN 4.3 LTR.

CHOICE OF HEATING

ELEMENTS :

 EXTERNAL INDUCTION
DEVICE

 FUEL

 INDUCTION UNIT
GO WITH STAND

 EXTERNAL ELECTRICAL
DEVICE



PRINCE

DELUXE INDUCTION CHAFING DISH

METROPOLITAN DESIGN AND SIMPLE SILHOUETTE, FORMING THE TOP CLASS IN ATHENA'S FAMILY. AN EVOLVED VERSION OF PATENTED HYDRAULIC HINGE IS APPLIED TO ALL MODELS IN THIS SERIES TO PROVIDE SMOOTH OPENING & SILENT CLOSING OF THE LID.

HEAVY GAUGE IN SHINY STAINLESS STEEL DEFINES IT'S QUALITY & DURABILITY. IT CAN BE USED DIRECTLY ON INDUCTION OR GO WITH MATCHING STAND FOR ELECTRIC OR CHAFER FUEL.

LID POSITION

- OPENS UP TO MAXIMUM 90°
- STAYS OPEN AT APPROX. 75°
- INITIATE TO CLOSE BY PRESSING DOWN GENTLY
- LID FALLS & CLOSSES AUTOMATICALLY & SILENTLY

- 18/10 STAINLESS STEEL BODY
- WITH CAPSULED BOTTOM COMPATIBLE FOR INDUCTION, CHAFER FUEL AND ELECTRIC HEATER
- EU1935/2004 FOOD SAFE STANDARD CONFORMED

NOISE STOPPER

- EASES NOISE OF CLOSING LID

WATER RETURN SYSTEM

- CONDENSATION FLOWS BACK TO WATER PAN INSTEAD OF FOOD

CONVENIENT NOTCH

- CHANGING FOOD PAN EASILY

CAPSULED BOTTOM

- MULTI-LAYER BOTTOM FOR FAST & EVEN HEATING

DETACHABLE LID

- FOR QUICK & EASY CLEANING

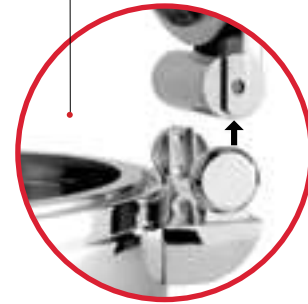

HYDRAULIC HINGE

- FOR SMOOTH OPENING & CLOSING OF LID

ADJUSTABLE LEVEL SUPPORT

- FOR A PERFECTLY LEVEL PLACEMENT WHEN REQUIRED



PRINCE
ROUND

ROUND CHAFING DISH

W/ GOLDEN ROSE LID 



4014002

DIMENSIONS

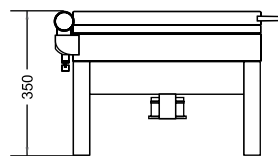
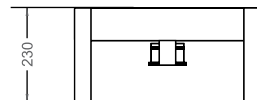
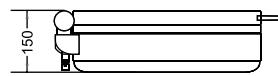
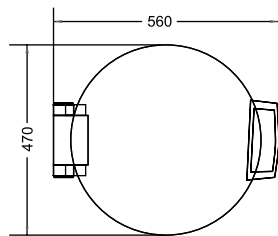

W/ STEEL LID 



4014001

4014001 WITH STAND



W/ GLASS LID 



4014003



STACKABLE DESIGN

- MATCHING STAND 4014004

OPTIONAL ACCESSORIES:

CHROME-NICKEL STAINLESS STEEL
EU 1935/2004 FOOD SAFE
STANDARD CONFORMED



4012436
36CM ROUND FOOD PAN 6.1 LTR.



4012536
DIVIDED 36CM ROUND FOOD PAN 5.8 LTR.

VITRIFIED NON-POROUS
PORCELAIN FOOD PAN

EU 1935/2004 FOOD SAFE
STANDARD CONFORMED



4012736
36CM ROUND FOOD PAN 6.1 LTR.



4012836
DIVIDED 36CM ROUND FOOD PAN 5.8 LTR.

CHOICE OF HEATING

ELEMENTS :



PRINCE
ROUND - SMALL

ROUND CHAFING DISH

W/ GOLDEN ROSE LID 



4014102

W/ STEEL LID 



4014101

W/ GLASS LID 



4014103

DIMENSIONS

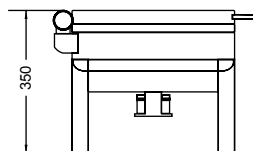
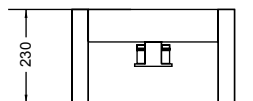
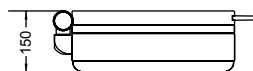
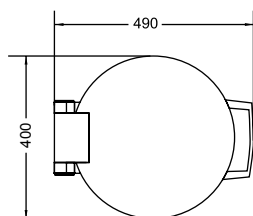

4014101 WITH STAND



STACKABLE DESIGN

- MATCHING STAND 4014104

OPTIONAL ACCESSORIES:

CHROME-NICKEL STAINLESS STEEL
EU 1935/2004 FOOD SAFE
STANDARD CONFORMED



4012428
28CM ROUND FOOD PAN 4.0 LTR.

VITRIFIED NON-POROUS
PORCELAIN FOOD PAN
EU 1935/2004 FOOD SAFE
STANDARD CONFORMED



4012728
28CM ROUND FOOD PAN 4.0 LTR.



4012828
DIVIDED 28CM ROUND FOOD PAN 2.5 LTR.

CHOICE OF HEATING
ELEMENTS :



PRINCE
SOUP STATION

SOUP STATION
W/ 11 LTR. SOUP BUCKET

W/ GOLDEN ROSE LID 



4014202

DIMENSIONS

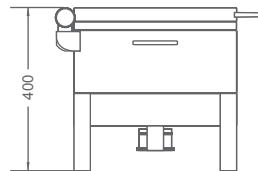
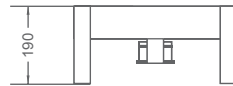
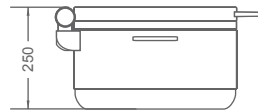
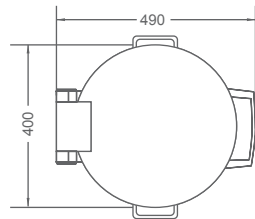

W/ STEEL LID 



4014201

4014201 WITH STAND



W/ GLASS LID 



4014203



- MATCHING STAND 4014204



PRINCE
GN 1 / 1

OBLONG CHAFING DISH

W/ GOLDEN ROSE LID 



4014302

DIMENSION

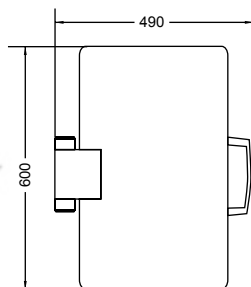

W/ STEEL LID 



4014301

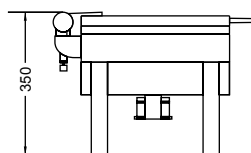
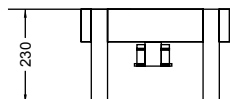
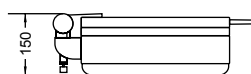

4014301 WITH STAND



W/ GLASS LID 



4014303



STACKABLE DESIGN

- MATCHING STAND 4014304

OPTIONAL ACCESSORIES:

CHROME-NICKEL STAINLESS STEEL
EU 1935/2004 FOOD SAFE
STANDARD CONFORMED

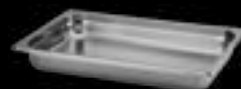

GN 1/1 FOOD PAN.
1150206 8.5 LTR.
1150210 13 LTR.



GN 1/2 FOOD PAN.
1150306 3.9 LTR.
1150310 5.9 LTR.

VITRIFIED NON-POROUS
PORCELAIN FOOD PAN
EU 1935/2004 FOOD SAFE
STANDARD CONFORMED







4012611
GN 1/1 FOOD PAN 9.0 LTR.



4012612
GN 1/2 FOOD PAN 4.3 LTR.

CHOICE OF HEATING
ELEMENTS :

-  EXTERNAL INDUCTION DEVICE
-  INDUCTION UNIT GO WITH STAND
-  FUEL
-  EXTERNAL ELECTRICAL DEVICE

PRINCE
GN 2/3

OBLONG CHAFING DISH

W/ GOLDEN ROSE LID 



4014602

DIMENSIONS

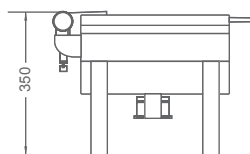
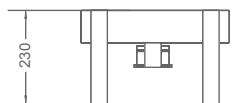
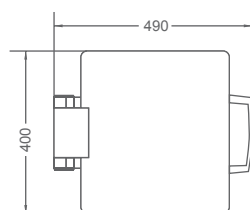

W/ STEEL LID 



4014601

4014601 WITH STAND



W/ GLASS LID 



4014603



STACKABLE DESIGN

- MATCHING STAND 4014604

OPTIONAL ACCESSORIES:

CHROME-NICKEL STAINLESS STEEL

EU 1935/2004 FOOD SAFE

STANDARD CONFORMED



GN 2/3 FOOD PAN.
1150406 5.3 LTR.
1150410 8.8 LTR.



GN 1/3 FOOD PAN.
1150506 2.4 LTR.
1150510 3.6 LTR.

VITRIFIED NON-POROUS
PORCELAIN FOOD PAN

EU 1935/2004 FOOD SAFE

STANDARD CONFORMED



4012623
GN 2/3 FOOD PAN 5.9 LTR.



4014523
DIVIDED GN 2/3 FOOD PAN 5.4 LTR.

CHOICE OF HEATING
ELEMENTS :

 EXTERNAL INDUCTION
DEVICE

 INDUCTION UNIT
GO WITH STAND

 FUEL

 EXTERNAL ELECTRICAL
DEVICE

PRINCE
GN 1/2

OBLONG CHAFING DISH

W/ GOLDEN ROSE LID 



4014702

DIMENSIONS

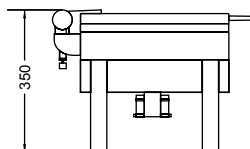
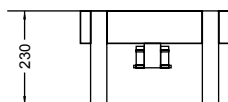
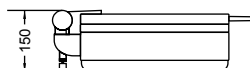
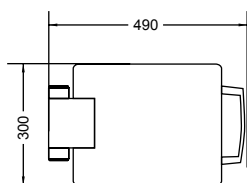

W/ STEEL LID 



4014701

4014701 WITH STAND



W/ GLASS LID 



4014703



STACKABLE DESIGN

- MATCHING STAND 4014704

OPTIONAL ACCESSORIES:

CHROME-NICKEL STAINLESS STEEL
EU 1935/2004 FOOD SAFE
STANDARD CONFORMED



GN 1/2 FOOD PAN.
1150306 3.9 LTR.
1150310 5.9 LTR.

VITRIFIED NON-POROUS
PORCELAIN FOOD PAN
EU 1935/2004 FOOD SAFE
STANDARD CONFORMED



4012612
GN 1/2 FOOD PAN 4.3 LTR.

CHOICE OF HEATING

ELEMENTS :

 EXTERNAL INDUCTION
DEVICE

 INDUCTION UNIT
GO WITH STAND

 FUEL

 EXTERNAL ELECTRICAL
DEVICE



PRINCESS

DELUXE INDUCTION CHAFING DISH

REFLECTS A PERFECT BLEND OF ELEGANT DESIGN AND PRACTICAL FUNCTION. THE DISH CAN GO BY ITSELF FOR QUICK & CONTEMPORARY SET UP OR ALONG WITH MATCHING STAND FOR A MORE CLASSIC ENVIRONMENT. COMMONLY USED HEATING SOURCES LIKE INDUCTION, ELECTRIC & CHAFER FUEL ARE ALL SUITABLE.

THE PATENTED HINGE MECHANISM ASSURES SMOOTH, GENTLE & SILENT OPENING & CLOSING OF LID- WHICH HELPS TO DEFINE THE CLASS OF A BUFFET.

LID POSITION

- OPENS UP TO MAXIMUM 90°
- STAYS OPEN AT APPROX. 75°
- INITIATE TO CLOSE BY PRESSING DOWN GENTLY
- LID FALLS & CLOSSES AUTOMATICALLY & SILENTLY

NOISE STOPPER

- EASES NOISE OF CLOSING LID

WATER RETURN SYSTEM

- CONDENSATION FLOWS BACK TO WATER PAN INSTEAD OF FOOD

CAPSULED BOTTOM

- MULTI-LAYER BOTTOM FOR FAST & EVEN HEATING

- 18/10 STAINLESS STEEL BODY

WITH CAPSULED BOTTOM COMPATIBLE FOR INDUCTION, CHAFER FUEL AND ELECTRIC HEATER

EU1935/2004 FOOD SAFE STANDARD CONFORMED

DETACHABLE LID

- FOR QUICK & EASY CLEANING

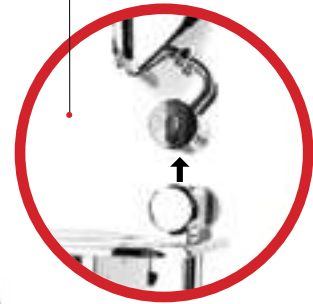

BUFFER HINGE

- FOR SMOOTH OPENING & CLOSING OF LID

ADJUSTABLE LEVEL SUPPORT

- FOR A PERFECTLY LEVEL PLACEMENT WHEN REQUIRED

INSERT LIFTING PIN

- CHANGING FOOD PAN EASILY



PRINCESS
GN 1/1

OBLONG CHAFING DISH

DIMENSIONS

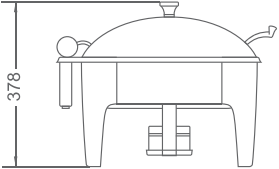
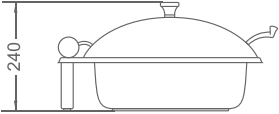
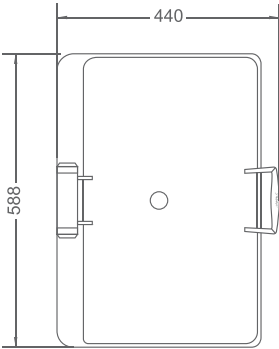

W/ GOLDEN ROSE LID



4011402

W/ STEEL LID



4011401

W/ GLASS LID



4011411

AIR-VENT KNOB

A-1011-GR WITH STAND   



4011402
MATCHING STAND
4011511



A-1011 WITH STAND   



4011401
MATCHING STAND
4011511



A-1011 L WITH STAND   



4011411
MATCHING STAND
4011511



AIR-VENT KNOB

OPTIONAL ACCESSORIES:

CHROME-NICKEL STAINLESS STEEL

EU 1935/2004 FOOD SAFE
STANDARD CONFORMED



GN 1/1 FOOD PAN.
1150206 8.5 LTR
1150210 13 LTR



GN 1/2 FOOD PAN.
1150306 3.9 LTR
1150310 5.9 LTR

VITRIFIED NON-POROUS
PORCELAIN FOOD PAN

EU 1935/2004 FOOD SAFE
STANDARD CONFORMED







GN 1/1 FOOD PAN 9.0 LTR.
4012611



GN 1/2 FOOD PAN 4.3 LTR.
4012612

CHOICE OF HEATING

ELEMENTS :

-  EXTERNAL INDUCTION
DEVICE
-  INDUCTION UNIT
GO WITH STAND
-  FUEL
-  EXTERNAL ELECTRICAL
DEVICE

PRINCESS
GN 2/3

OBLONG CHAFING DISH

DIMENSIONS

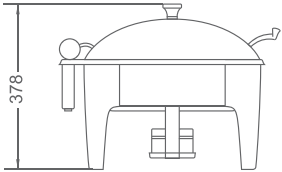
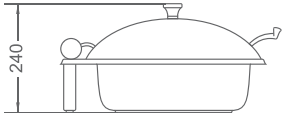
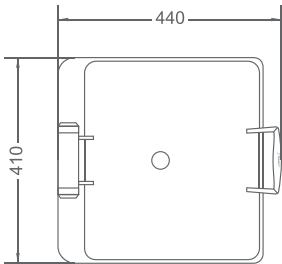

W/ GOLDEN ROSE LID 



4011802

W/ STEEL LID 



4011801

W/ GLASS LID 



4011832

AIR-VENT KNOB

A-1032-GR WITH STAND   



4011802
MATCHING STAND
4011932

A-1032 WITH STAND   



4011801
MATCHING STAND
4011932

A-1032 L WITH STAND   



4011801
MATCHING STAND
4011932

AIR-VENT KNOB

OPTIONAL ACCESSORIES:

CHROME-NICKEL STAINLESS STEEL

EU 1935/2004 FOOD SAFE
STANDARD CONFORMED



GN 2/3 FOOD PAN.
1150406 5.3 LTR.
1150410 8.8 LTR.



GN 1/3 FOOD PAN.
1150506 24 LTR.
1150510 3.6 LTR.

VITRIFIED NON-POROUS
PORCELAIN FOOD PAN

EU 1935/2004 FOOD SAFE
STANDARD CONFORMED



4012623
GN 2/3 FOOD PAN 5.9 LTR.



4014523
DIVIDED GN 2/3 FOOD PAN 5.4 LTR.

CHOICE OF HEATING

ELEMENTS :

 EXTERNAL INDUCTION
DEVICE

 INDUCTION UNIT
GO WITH STAND

 FUEL

 EXTERNAL ELECTRICAL
DEVICE

PRINCESS
GN 1/2

OBLONG CHAFING DISH

DIMENSIONS

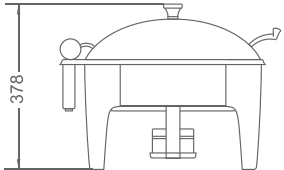
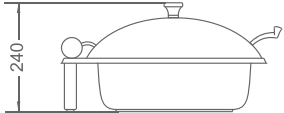
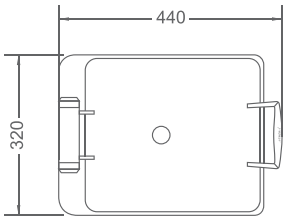

W/ GOLDEN ROSE LID



4011602

W/ STEEL LID



4011601

W/ GLASS LID



4011621

AIR-VENT KNOB

A-1021-GR WITH STAND   



4011602
MATCHING STAND
4011721

A-1021 WITH STAND   



4011601
MATCHING STAND
4011721

A-1021 L WITH STAND   



4011621
MATCHING STAND
4011721

AIR-VENT KNOB

OPTIONAL ACCESSORIES:

CHROME-NICKEL STAINLESS STEEL
EU 1935/2004 FOOD SAFE
STANDARD CONFORMED



GN 1/2 FOOD PAN.
1150306 3.9 LTR.
1150310 5.9 LTR.

VITRIFIED NON-POROUS
PORCELAIN FOOD PAN
EU 1935/2004 FOOD SAFE
STANDARD CONFORMED



GN 1/2 FOOD PAN.
4012612 4.3 LTR

CHOICE OF HEATING
ELEMENTS :

 EXTERNAL INDUCTION
DEVICE

 INDUCTION UNIT
GO WITH STAND

 FUEL

 EXTERNAL ELECTRICAL
DEVICE

PRINCESS
ROUND

ROUND CHAFING DISH

DIMENSIONS

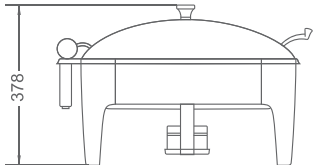
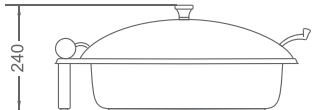
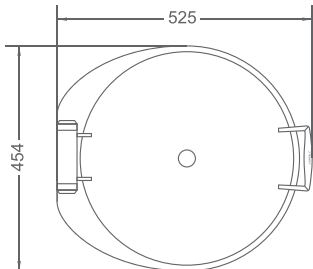

W/ GOLDEN ROSE LID



4012002

W/ STEEL LID



4012001

W/ GLASS LID



4012060

AIR-VENT KNOB

A-1060-GR WITH STAND   



4012002
MATCHING STAND
4012160

A-1060 WITH STAND   



4012001
MATCHING STAND
4012160

A-1060 L WITH STAND   



4012060
MATCHING STAND
4012160

AIR-VENT KNOB

OPTIONAL ACCESSORIES:

CHROME-NICKEL STAINLESS STEEL
EU 1935/2004 FOOD SAFE
STANDARD CONFORMED



4012436
36CM ROUND FOOD PAN 6.1 LTR.



4012536
DIVIDED 36CM ROUND FOOD PAN 5.8 LTR.

VITRIFIED NON-POROUS
PORCELAIN FOOD PAN

EU 1935/2004 FOOD SAFE
STANDARD CONFORMED



4012736
36CM ROUND FOOD PAN 6.1 LTR.



4012836
DIVIDED 36CM ROUND FOOD PAN 5.8 LTR.

CHOICE OF HEATING

ELEMENTS :

 EXTERNAL INDUCTION
DEVICE

 INDUCTION UNIT
GO WITH STAND

 FUEL

 EXTERNAL ELECTRICAL
DEVICE

PRINCESS
SOUP STATION

SOUP STATION

DIMENSIONS

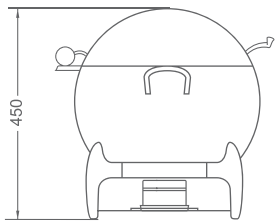
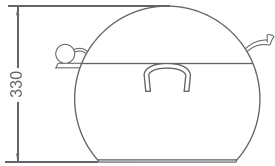
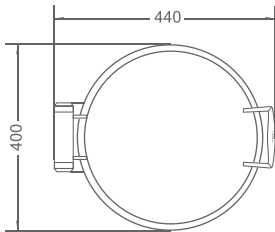

W/ GOLDEN ROSE LID 



4014802

A-10-11-GR WITH STAND  



4014802
MATCHING STAND 4014804

W/ STEEL LID 



4014801

A-10-11 WITH STAND  



4014801
MATCHING STAND 4014804

W/ GLASS LID 



AIR-VENT KNOB

4014803

A-10-11 L WITH STAND  



4014803
MATCHING STAND 4014804

CHOICE OF HEATING
ELEMENTS :

 EXTERNAL INDUCTION
DEVICE

 INDUCTION UNIT
GO WITH STAND

 FUEL

IMPERIAL & METRO

DELUXE BUFFER HINGED ROLL TOP CHAFING DISH

MAKE USE OF A PAIR OF MINI-BUFFER HINGE WHICH CONTROL THE SPEED AND STRENGTH OF THE LID MOTION TO ENSURE A SMOOTH AND SILENT OPERATION. THE LID IS DETACHABLE FOR EASY CLEANING AND FEATURED WITH WATER RETURN SYSTEM.

TWO CHOICES OF HANDLE AND LEG ARE AVAILABLE - OFFERING MATCHING OPTIONS FOR DIFFERENT BUFFET SETTINGS. BOTH DESIGNS ARE STACKABLE FOR EASY STORAGE.



IMPERIAL REGENCY

DELUXE BUFFER
HINGED ROLL TOP
CHAFING DISH

OPTIONAL ACCESSORIES:

CHROME-NICKEL STAINLESS STEEL
EU 1935/2004 FOOD SAFE
STANDARD CONFORMED

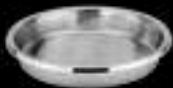

4012436
36CM ROUND FOOD PAN 6.1 LTR.



4012536
DIVIDED 36CM ROUND FOOD PAN 5.8 LTR.

VITRIFIED NON-POROUS
PORCELAIN FOOD PAN

EU 1935/2004 FOOD SAFE
STANDARD CONFORMED



4012736
36CM ROUND FOOD PAN 6.1 LTR.



4012836
DIVIDED 36CM ROUND FOOD PAN 5.8 LTR.

CHOICE OF HEATING
ELEMENTS :



INDUCTION UNIT
GO WITH STAND



FUEL

4010701S

- ROUND BUFFER HINGED ROLL TOP CHAFING DISH WITH CASTED ALLOY LEGS
- COMPLETED WITH 6.1 LTR. FOOD PAN & FUEL HOLDER

STACKABLE DESIGN



STAYS OPEN AT 90°



FULLY OPEN AT 180°



STACKABLE DESIGN

4010800S

- ROUND BUFFER HINGED ROLL TOP SOUP STATION WITH CASTED ALLOY LEGS
- COMPLETED WITH 10.0 LTR. SOUP BUCKET & FUEL HOLDER

STACKABLE DESIGN



ACCESSORIES:



4010801
SOUP BUCKET 10.0 LTR FOR
4010800 / 4010802



4010901
ADAPTING PLATE FOR
4010800 / 4010802



FULLY OPEN AT 180°



4011001S

- GN 1/1 BUFFER HINGED ROLL TOP CHAFING DISH WITH CASTED ALLOY LEGS
- COMPLETED WITH 9.0 LTR. FOOD PAN & FUEL HOLDERS

STACKABLE DESIGN



STAYS OPEN AT 90°



STACKABLE DESIGN



FULLY OPEN AT 180°

4011101S



- GN 1/1 BUFFER HINGED ROLL TOP SOUP STATION WITH CASTED ALLOY LEGS
- COMPLETED WITH 2x4.5 LTR. SOUP BUCKET & FUEL HOLDERS

STACKABLE DESIGN



ACCESSORIES:



FULLY OPEN AT 180°



4011201
SOUP BUCKET 4.5 LTR FOR
4011101 / 4011102



4011301
ADAPTING PLATE FOR
4011101 / 4011102

OPTIONAL ACCESSORIES:

CHROME-NICKEL STAINLESS STEEL

EU 1935/2004 FOOD SAFE
STANDARD CONFORMED



GN 1/1 FOOD PAN.
1150206 8.5 LTR.
1150210 13 LTR.



GN 1/2 FOOD PAN.
1150306 3.9 LTR.
1150310 5.9 LTR.

VITRIFIED NON-POROUS
PORCELAIN FOOD PAN

EU 1935/2004 FOOD SAFE
STANDARD CONFORMED



4012611
GN 1/1 FOOD PAN 9.0 LTR.



4012612
GN 1/2 FOOD PAN 4.3 LTR.

METRO
DELUXE BUFFER
HINGED ROLL TOP
CHAFING DISH

OPTIONAL ACCESSORIES:

CHROME-NICKEL STAINLESS STEEL
EU 1935/2004 FOOD SAFE
STANDARD CONFORMED



4012436
36CM ROUND FOOD PAN 6.1 LTR.



4012536
DIVIDED 36CM ROUND FOOD PAN 5.8 LTR.

VITRIFIED NON-POROUS
PORCELAIN FOOD PAN
EU 1935/2004 FOOD SAFE
STANDARD CONFORMED





4012736
36CM ROUND FOOD PAN 6.1 LTR.



4012836
DIVIDED 36CM ROUND FOOD PAN 5.8 LTR.

**CHOICE OF HEATING
ELEMENTS :**



4010702  

- ROUND BUFFER HINGED ROLL TOP CHAFING DISH WITH TUBULAR LEGS
- COMPLETED WITH 6.1 LTR. FOOD PAN & FUEL HOLDER

STACKABLE DESIGN





STAYS OPEN AT 90°



STACKABLE DESIGN



FULLY OPEN AT 180°

4010802  

- ROUND BUFFER HINGED ROLL TOP SOUP STATION WITH TUBULAR LEGS
- COMPLETED WITH 10.0 LTR. SOUP BUCKET & FUEL HOLDER

STACKABLE DESIGN



ACCESSORIES:



4010801
SOUP BUCKET 10.0 LTR FOR
4010800 / 4010802



FULLY OPEN AT 180°



4010901
ADAPTING PLATE FOR
4010800 / 4010802

4011002



- GN 1/1 BUFFER HINGED ROLL TOP CHAFING DISH WITH TUBULAR LEGS
- COMPLETED WITH 9.0 LTR. FOOD PAN & FUEL HOLDERS

STACKABLE DESIGN



STAYS OPEN AT 90°



STACKABLE DESIGN



FULLY OPEN AT 180°

4011102



- GN 1/1 BUFFER HINGED ROLL TOP SOUP STATION WITH TUBULAR LEGS
- COMPLETED WITH 2x4.5 LTR. SOUP BUCKET & FUEL HOLDERS

STACKABLE DESIGN



FULLY OPEN AT 180°

ACCESSORIES:



4011201
SOUP BUCKET 4.5 LTR FOR
4011101 / 4011102



4011301
ADAPTING PLATE FOR
4011101 / 4011102

OPTIONAL ACCESSORIES:

CHROME-NICKEL STAINLESS
EU 1935/2004 FOOD SAFE
STANDARD CONFORMED

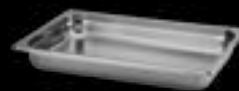

GN 1/1 FOOD PAN.
1150206 8.5 LTR.
1150210 13 LTR.



GN 1/2 FOOD PAN.
1150306 3.9 LTR.
1150310 5.9 LTR.

VITRIFIED NON-POROUS
PORCELAIN FOOD PAN
EU 1935/2004 FOOD SAFE
STANDARD CONFORMED



4012611
GN 1/1 FOOD PAN 9.0 LTR.



4012612
GN 1/2 FOOD PAN 4.3 LTR.



IMPERIAL MINI

ELEGANT AND COMPACT, AVAILABLE
IN 3 CAPACITIES, IDEAL CHOICE
FOR SMALL EVENTS AND EXECUTIVE
LOUNGE WITH LIMITED SPACE



LID POSITION
– OPENS UP TO MAXIMUM 95°



MINI SOUP TUREEN
4012225 / 2.5L
OPTIONAL 2.5L PORCELAIN SAUCE PAN
4012325



SAUCE TUREEN
4012215 / 1.5L
OPTIONAL 1.5L PORCELAIN SAUCE PAN
4012315



MINI CHAFING DISH
4012210 / 1L
OPTIONAL 1.0L PORCELAIN FOOD PAN
4012310

OPTIONAL ACCESSORIES:

VITRIFIED NON-POROUS
PORCELAIN FOOD PAN
EU 1935/2004 FOOD SAFE
STANDARD CONFORMED



4012310
Ø20×7.5CM FOOD PAN 1.0 LTR.



4012315
Ø20×10CM SAUCE PAN 1.5 LTR.



4012325
Ø20×15.5CM SAUCE PAN 2.5 LTR.

DISPENSERS



FRONT: IMPERIAL 11L COFFEE URN
ACU-01.11000

MIDDLE: KOOL 5L JUICE DISPENSER
AJD-03.5000

BACK: METRO 6L MILK DISPENSER
AMD-02.6000

CHOICE OF HEATING ELEMENT



- PRINCESS GN 1/1 W/ STAND
- PRINCE GN 1/1 W/ STAND



- PRINCESS GN 2/3 W/ STAND
- PRINCE GN 2/3 W/ STAND



- PRINCESS GN 1/2 W/ STAND
- PRINCE GN 1/2 W/ STAND



- PRINCESS ROUND W/ STAND
- PRINCE ROUND W/ STAND
- PRINCE SMALL ROUND W/ STAND



- PRINCESS GN 1/1
- PRINCE GN 1/1



- PRINCESS GN 2/3
- PRINCE GN 2/3



- PRINCESS GN 1/2
- PRINCE GN 1/2



- PRINCESS GN 1/1 W/ STAND



- PRINCESS GN 2/3 W/ STAND



- PRINCESS GN 1/2 W/ STAND



- PRINCESS ROUND W/ STAND



- PRINCE GN 1/1 W/ STAND



- PRINCE GN 2/3 W/ STAND



- PRINCE GN 1/2 W/ STAND



- PRINCE ROUND W/ STAND
- PRINCE SMALL ROUND W/ STAND



- PRINCESS SOUP STATION W/ STAND

+



4014901
ADAPTING PLATE



4015001



COMPACT INDUCTION WARMER
Ø 245MM × 65MM(H)
1000W, 220V - 240V



- IMPERIAL 11L COFFEE URN



- IMPERIAL 20L COFFEE URN



A-FH-01



FUEL HOLDER
Ø 90 MM × 60MM(H)



• PRINCESS SOUP STATION W/ STAND
• PRINCE SOUP STATION W/ STAND



• IMPERIAL CHAFING DISH



• METRO CHAFING DISH



A-FH-01



• PRINCESS ROUND
• PRINCE ROUND
• PRINCE SMALL ROUND



• PRINCESS SOUP STATION
• PRINCE SOUP STATION



A-I-2000B

+



4014903
ADAPTING PLATE



4012901



ELECTRICAL WARMER
300MM x 200MM x 20MM(H)
700W, 110V OR 220V



4015001



COMPACT INDUCTION WARMER
Ø 245MM x 65MM(H)
1000W, 220V - 240V

CE



• PRINCE SOUP STATION W/ STAND



4012902



ELECTRICAL WARMER
255MM x 200MM x 20MM(H)
500W, 110V OR 220V



4015001



COMPACT INDUCTION WARMER
Ø 245MM x 65MM(H)
1000W, 220V - 240V

CE



• IMPERIAL CHAFING DISH



• METRO CHAFING DISH

+



4014902
ADAPTING PLATE



4015001



COMPACT INDUCTION WARMER
Ø 245MM x 65MM(H)
1000W, 220V - 240V

CE



• IMPERIAL 11L COFFEE URN



4015002



COMPACT INDUCTION WARMER
Ø 180MM x 75MM(H)
800W, 110V OR 220V



• IMPERIAL 20L COFFEE URN



4015001



COMPACT INDUCTION WARMER
Ø 245MM x 65MM(H)
1000W, 220V - 240V

CE



IMPERIAL

CASTED ALLOY LEGS

MILK DISPENSER



4030106 / 6L

JUICE DISPENSER



4030101 / 8L

COFFEE URN  



4033511 / 11L



4033520 / 20L

CHOICE OF HEATING ELEMENTS :  FUEL  INDUCTION UNIT GO WITH STAND

METRO

STEEL BASE

MILK DISPENSER



4033406 / 6L

JUICE DISPENSER



4030102 / 8L

CEREAL DISPENSER



4031808 / 8L

KOOL

NATURAL ACACIA BASE

MILK DISPENSER



4030404 / 4L

JUICE DISPENSER



4030103 / 5L

Stainless Steel Chafing Dish

不锈钢餐炉



Round Roll Top

CODE	SIZE (l x w x h cm)	CAPACITY	REMARKS
4010101	47.5 x 52 x 46.5	6 Ltr	721



Rectangle 2/3 Roll Top

CODE	SIZE (l x w x h cm)	CAPACITY	REMARKS
4010102	48.5 x 47 x 44	6 Ltr	722



Rectangle 1/1 Roll Top

CODE	SIZE (l x w x h cm)	CAPACITY	REMARKS
4010103	64 x 49.5 x 44	9 Ltr	723



Oval Roll Top

CODE	SIZE (l x w x h cm)	CAPACITY	REMARKS
4010104	66 x 55 x 46.5	9 Ltr	736

Optional Accessories for Roll Top Chafing Dish 不锈钢汤桶



Round Adaptor Plate

CODE	SIZE (Ø cm)	REMARKS
4010301	39 x 3	730P Fit 4010101



Deluxe Soup Bucket

CODE	SIZE (Ø x h cm)	CAPACITY	REMARKS
4010302	36 x 27	10 Ltr	730SB



Rectangle Adaptor Plate

CODE	SIZE (l x w x h cm)	REMARKS
4010401	53.5 x 34 x 3	738P Fit 4010103



Deluxe Soup Bucket

CODE	SIZE (Ø x h cm)	CAPACITY	REMARKS
4010402	29.5 x 22	4.5 Ltr	738SB



Stainless Steel Chafing Dish 不锈钢餐炉



Rectangle 1/1 Size

CODE	SIZE (l x w x h cm)	CAPACITY	REMARKS
4010201	64 x 35 x 33	9 Ltr	033



Rectangle 1/1 Size

CODE	SIZE (l x w x h cm)	CAPACITY	REMARKS
4010202	60 x 35 x 32	9 Ltr	633



Rectangle 1/2 Size

CODE	SIZE (l x w x h cm)	CAPACITY	REMARKS
4010203	43 x 30 x 32	4.5 Ltr	834



Rectangle 1/1 Size Foldable Stand

CODE	SIZE (l x w x h cm)	CAPACITY	REMARKS
4010204	57 x 35 x 31.5	9 Ltr	533



Round

CODE	SIZE (l x w x h cm)	CAPACITY	REMARKS
4013735	42 x 34 x 30	3.5 Ltr	831
4013750	42 x 34 x 30	5.0 Ltr	831L



Round

CODE	SIZE (l x w x h cm)	CAPACITY	REMARKS
4013113	42 x 34 x 40	13.5 Ltr	H835

Stainless Steel Soup Warmer with Notched Cover 圆盖汤餐炉

CODE	SIZE (l x w x h cm)	Ltr
4013801	31 x 24 x 32	7
4013811	36 x 29 x 32	11



Electric Warmer 电热板

CODE	SIZE (l x w x h cm)	POWER	REMARK
4012901	30 x 20 x 2	220V / 700V	for rectangle chafers use
4012902	25.5 x 20 x 2	220V / 700V	for round chafers use



Rectangular Wooden Steamer 长形方角柳杉木蒸笼

CODE	SIZE (l x w x h cm)	
5101511	32.5 x 53	For 1/4 Size
5101523	35.0 x 33	For 2/3 Size
5101512	28.0 x 34	For 1/2 Size



Rectangular Wooden Cover Only 长形方角柳杉木蒸笼盖

CODE	SIZE (l x w x h cm)	
5101711	32.5 x 53	For 1/4 Size
5101723	35.0 x 33	For 2/3 Size
5101712	28.0 x 34	For 1/2 Size



Round Wooden Steamer Base & Cover 圆形柳杉木蒸笼

CODE	SIZE (l x w x h cm)	(inch)	
5101616	40	16"	Body
5101816	40	16"	Cover



* Above Bamboo Steamers are available in Customized sizes.
Please contact us for more details.

FOOD SERVICE & BUFFET WARE



Heating Wax 桶蜡

CODE	CAPACITY
4020414	14 Kg



Heating Wax 蜡

CODE	CAPACITY	PACKING
4020208	8oz	72 Cans / Ctn



Heating Gel 胶

CODE	CAPACITY	PACKING
4020308	8oz	72 Cans / Ctn



Heating Gel In Bottle 胶

CODE	SPECIFICATION
4020501	1 Lit



Individual Solid Heating Cube 蜡

CODE	CAPACITY	PACKING
4020610	10 gram	20 pcs/ pack
4020620	20 gram	20 pcs/ pack



- Resealable
- Non Flammable
- Non Combustible
- Visible Flame
- Cans Stay Cool
- Odourless
- See Through with Graduation
(Plastic Can only - able to determine hours left)



Available In:



4 Hours
Plastic Can
Code: 4020704

4 Hours
Metal Can
Code: 4020104

6 Hours
Metal Can
Code: 4020106

6 Hours
Plastic Can
Code: 4020706

Packing : 40 cans/ctn

Picnic • Camping • Cooking • Buffet

FOOD SERVICE & BUFFET WARE

100% Made in Italy

Stainless Steel Cereal / Juice / Milk Dispenser



Single Cereal Dispenser

谷物分配器

CODE	SIZE (l x w x h cm)	CAPACITY Ltr
4031903	18 x 18 x 57	3



Double Cereal Dispenser

谷物分配器

CODE	SIZE (l x w x h cm)	CAPACITY Ltr
4032032	33 x 18 x 57	3 x 2



Single Milk Dispenser

果汁鼎

CODE	SIZE (l x w x h cm)	CAPACITY Ltr
4030306	22 x 38 x 55	6



Single Drinks Dispenser

果汁鼎

CODE	SIZE (l x w x h cm)	CAPACITY Ltr
4030204	19 x 33 x 54	4
4030207	22 x 38 x 61	7



Display Tray with 3 Polycarbonate Pitchers

果汁 / 谷物壶

CODE	SIZE (l x w x h cm)	CAPACITY Ltr
4030503	50 x 16 x 33	3 Ltr x 3

Economy Stainless Steel Juice Dispenser

Single Tank

钢果汁鼎

CODE	SPECIFICATION
4030671	7 Ltr



Double Tank

钢果汁鼎

CODE	SPECIFICATION
4030672	2 x 7 Ltr



Triple Tank

钢果汁鼎

CODE	SPECIFICATION
4030673	3 x 7 Ltr



V-Style Single Tank

V型钢果汁鼎

CODE	CAP
4030700	7 Ltr



Slim Style Single Tank

钢单头（瘦身）果汁鼎

CODE	SIZE (l x w x h cm)	CAP
4030814	20 x 30 x 52	4 Ltr



Single Octagon Tank

钢单头八角果汁鼎

CODE	SIZE (l x w x h cm)	CAP
4030925	21 x 30 x 52	4 Ltr
4030935	26 x 35 x 57	7 Ltr



Economy Stainless Steel Juice Dispenser



V-Style Milk Dispenser
V型钢牛奶鼎

CODE	SIZE (l x w x h cm)	CAPACITY
4031103	36 x 26 x 51	7 Ltr

Milk Dispenser
不锈钢奶鼎

CODE	SIZE (l x w x h cm)	CAPACITY
4031208	35 x 26 x 54	5 Ltr



Coffee Urn with Stand
不锈钢咖啡鼎

**GOURMET
STEEL**

CODE	SIZE (Ø cm)	CAPACITY
4031312	30 x 57	12 Ltr
4031412	30 x 70	19 Ltr



Deluxe Coffee Warmer
不锈钢咖啡鼎

CODE	CAPACITY
4031503	12 Ltr



Single Cereal Dispenser
单头谷物分配器

CODE	SIZE (l x w x h cm)	CAPACITY
4032101	34.8 x 25.8 x 66	7 Ltr



Double Cereal Dispenser
双头谷物分配器

CODE	SIZE (l x w x h cm)	CAPACITY
4032102	47.8 x 26.8 x 66	2 x 7 Ltr



Chilled Yoghurt Stand 冷冻酸奶盆

CODE	SIZE (l x w x h cm)
4032425	24



Round Cheese Display Roll Top 不锈钢有盖芝士陈列盆

CODE	SIZE (l x w x h cm)
4032500	48 x 25

18/10 Champagne / Punch Bowl (Mirror Finish) 不锈钢香槟碗

CODE	SIZE (l x w x h cm)
4032740	40



Economy Round Punch / Salad Bowl 经济型不锈钢沙拉碗

GOURMET
STEEL

CODE	SIZE	
	(l x w x h cm)	(inch)
4032614	36	14
4032615	38	15
4032616	40	16
4032617	43	17

1 Pc Deluxe Punch Ladle 饮料盆长勺

CODE	SIZE (l x w x h cm)
4032900	8 x 32



Pebbled Pedestal Punch Bowls 橘纹饮料盆

CAMBRO

CODE	SIZE (l x w x h cm)
4032815	38.0
4032818	45.7
4032823	58.4

FOOD SERVICE & BUFFET WARE

Mirror Finished Stainless Steel Display Tray 钢托盘



Oval

CODE	SIZE	
	(l x w cm)	(inch)
4050116	39.0 x 29.0	16 x 12.0
4050118	46.0 x 32.0	18 x 13.0
4050120	50.8 x 36.5	20 x 14.25
4050122	57.5 x 44.5	22 x 18.0



Round

CODE	SIZE	
	(Ø cm)	(inch)
4050216	40.6	16
4050218	45.7	18
4050220	50.8	20
4050222	55.8	22



Rectangular

CODE	SIZE	
	(l x w cm)	(inch)
4050316	39.5 x 29.0	16.0 x 12.0
4050318	48.0 x 32.5	18.0 x 13.0
4050320	52.0 x 37.0	20.5 x 14.5
4050322	56.5 x 42.0	22.0 x 18.0



Oval

CODE	SIZE	
	(l x w cm)	(inch)
4050416	39.0 x 29.0	16 x 12.0
4050418	46.0 x 32.0	18 x 13.0
4050420	50.8 x 36.5	20 x 14.25
4050422	57.5 x 44.5	22 x 18.0



Oval

CODE	SIZE	
	(l x w cm)	(inch)
4050516	39.0 x 29.0	16 x 12.0
4050518	46.0 x 32.0	18 x 13.0
4050520	50.8 x 36.5	20 x 14.25
4050522	57.5 x 44.5	22 x 18.0



Round

CODE	SIZE	
	(Ø cm)	(inch)
4050616	40.6	16
4050618	45.7	18
4050620	50.8	20
4050622	55.8	22



Round

CODE	SIZE	
	(Ø cm)	(inch)
4050716	40.6	16
4050718	45.7	18
4050720	50.8	20
4050722	55.8	22



Rectangular

CODE	SIZE	
	(l x w cm)	(inch)
4050816	39.5 x 29.0	16.0 x 12.0
4050818	48.0 x 32.5	18.0 x 13.0
4050820	52.0 x 37.0	20.5 x 14.5
4050822	56.5 x 42.0	22.0 x 18.0

Rectangular

CODE	SIZE	
	(l x w cm)	(inch)
4050916	39.5 x 29.0	16.0 x 12.0
4050918	48.0 x 32.5	18.0 x 13.0
4050920	52.0 x 37.0	20.5 x 14.5
4050922	56.5 x 42.0	22.0 x 18.0



18/10 Stainless Steel Serving Tray 不锈钢托盘



Round

CODE	SIZE
	(Ø cm)
4051012	12.5
4051016	16.0
4051026	26.0
4051030	30.0
4051034	34.0
4051037	37.0
4051045	45.0

PIAZZA



Rectangular

CODE	SIZE
	(l x w cm)
4051125	25 x 19
4051134	34 x 27
4051140	40 x 32
4051146	46 x 35
4051152	52 x 38
4051160	60 x 45

PIAZZA

Rectangular with Handle

CODE	SIZE
	(l x w cm)
4051240	40 x 32
4051246	46 x 35
4051252	52 x 38
4051260	60 x 45

PIAZZA



NATURE FUSION



Buffet created by
Régis & Jacques MARCON
in St Bonnet le Froid forest
(France - 43)

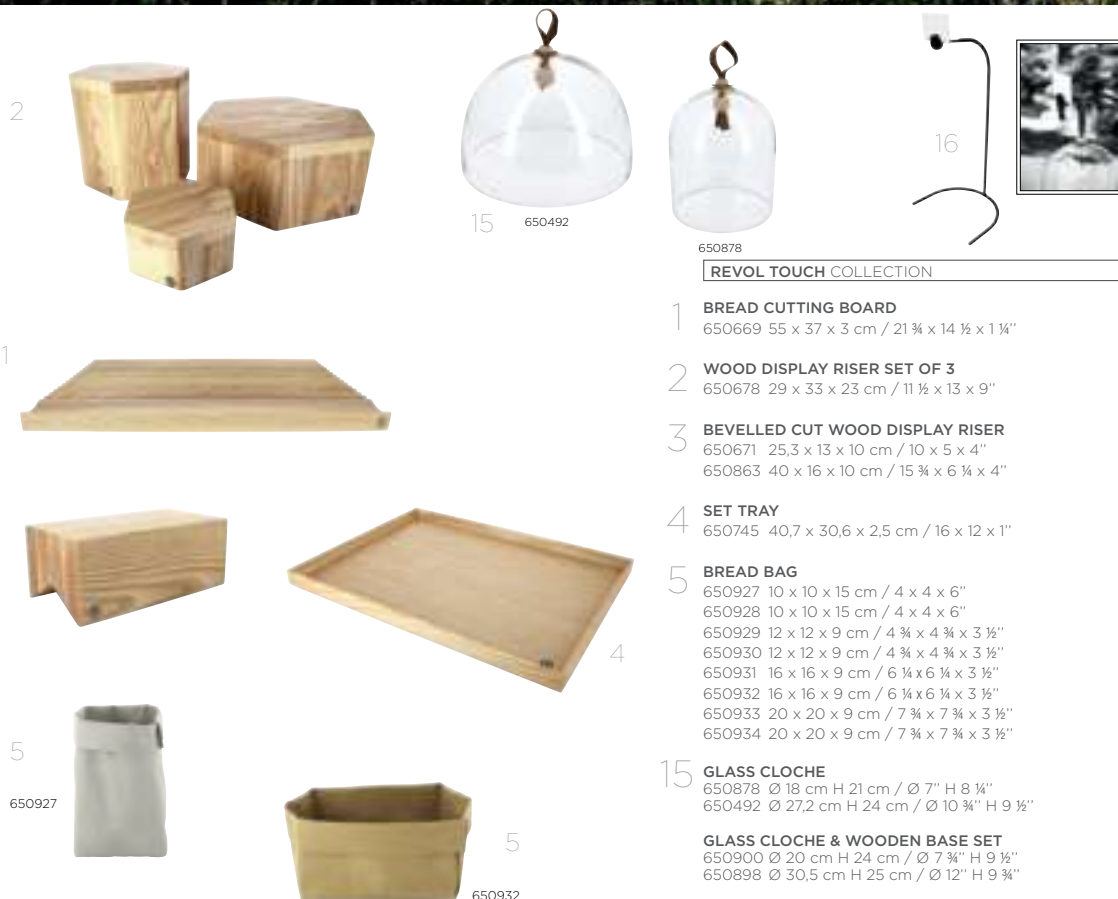

REVOL TOUCH COLLECTION

- 1 **BREAD CUTTING BOARD**
650669 55 x 37 x 3 cm / 21 ¾ x 14 ½ x 1 ¼" ●
- 2 **WOOD DISPLAY RISER SET OF 3**
650678 29 x 33 x 23 cm / 11 ½ x 13 x 9" ●
- 3 **BEVELLED CUT WOOD DISPLAY RISER**
650671 25,3 x 13 x 10 cm / 10 x 5 x 4" ●
650863 40 x 16 x 10 cm / 15 ¾ x 6 ¼ x 4" ●
- 4 **SET TRAY**
650745 40,7 x 30,6 x 2,5 cm / 16 x 12 x 1" ●
- 5 **BREAD BAG**
650927 10 x 10 x 15 cm / 4 x 4 x 6" ●
650928 10 x 10 x 15 cm / 4 x 4 x 6" ●
650929 12 x 12 x 9 cm / 4 ¾ x 4 ¾ x 3 ½" ●
650930 12 x 12 x 9 cm / 4 ¾ x 4 ¾ x 3 ½" ●
650931 16 x 16 x 9 cm / 6 ¼ x 6 ¼ x 3 ½" ●
650932 16 x 16 x 9 cm / 6 ¼ x 6 ¼ x 3 ½" ●
650933 20 x 20 x 9 cm / 7 ¾ x 7 ¾ x 3 ½" ●
650934 20 x 20 x 9 cm / 7 ¾ x 7 ¾ x 3 ½" ●
- 15 **GLASS CLOCHE**
650878 Ø 18 cm H 21 cm / Ø 7" H 8 ¼" ●
650492 Ø 27,2 cm H 24 cm / Ø 10 ¾" H 9 ½" ●
- GLASS CLOCHE & WOODEN BASE SET**
650900 Ø 20 cm H 24 cm / Ø 7 ¾" H 9 ½" ●
650898 Ø 30,5 cm H 25 cm / Ø 12" H 9 ¾" ●
- 16 **CLOCHE HOLDER**
651034 18,4 x 22 x 46,4 cm / 7 ¼ x 8 ¾ x 18 ¼" ●



REVOL ODE TO NATURE

Bathing in the softness of the sun's rays, the buffet appears as if by magic. In one instant, our senses are awakened. The heady smell of undergrowth and the raw materials simply transformed appeal to our appetite. The richness of the textures and the rhythm created by the different heights of the accessories guide our eyes. Nature is here, radiant and generous.



BASALT COLLECTION

- 6 **BOWL**
642035 Ø 10cm H 6cm 25cl / Ø 4" H 2 ¼" 8 ¾ oz ■
649059 Ø 14cm H 8cm 60cl / Ø 5 ½" H 3 ¼" 21 ¼ oz ■
- 7 **INDIVIDUAL SERVING BOWL**
650957 Ø 22cm H 5,5cm 1L / Ø 8 ¾" H 2 ¼" 35 ¼ oz ■
- 8 **RECTANGULAR TRAY, 1/2 GASTRO**
642500 32,5 x 26,5 x 1 cm / 12 ¾ x 10 ½ x ½" ■
- 9 **RECTANGULAR TRAY, 2/4 GASTRO**
644986 54 x 16,5 x 0,8 cm / 21 ¼ x 6 ½ x ¼" ■
- 10 **RECTANGULAR TRAY, LARGE**
645215 40 x 25 x 0,7 cm / 15 ¾ x 9 ¾ x ¼" ■
640598 40 x 30 x 0,7 cm / 15 ¾ x 11 ¾ x ¼" ■
- 11 **ROUND PLATE**
641316 Ø 28,5 cm H 1,5 cm / Ø 11 ¼" H ½" ■
641010 Ø 32 cm H 1,5 cm / Ø 12 ½" H ½" ■

ARBORESCENCE COLLECTION

- 12 **RECTANGULAR PLATE 12 ½"**
648307 32 x 23 x 2,4 cm / 12 ½ x 9 x 1" ●
648308 32 x 23 x 2,4 cm / 12 ½ x 9 x 1" ●
648309 32 x 23 x 2,4 cm / 12 ½ x 9 x 1" ●
- 13 **COUPE DISH, LARGE, 123 ½ OZ**
650448 Ø 33,5 cm H 9 cm / Ø 13 ¼" H 3 ½" ●
650449 Ø 33,5 cm H 9 cm / Ø 13 ¼" H 3 ½" ●
650450 Ø 33,5 cm H 9 cm / Ø 13 ¼" H 3 ½" ●
- 14 **SALAD BOWL 88 ¼ OZ**
650476 Ø 27,3 cm H 10 cm / Ø 10 ¾" H 4" ●
650477 Ø 27,3 cm H 10 cm / Ø 10 ¾" H 4" ●
650478 Ø 27,3 cm H 10 cm / Ø 10 ¾" H 4" ●

- Oak
- Ivory
- Light Grey
- Liquorice
- Havana Brown
- Pepper
- Matt Slate Style

CLASSIC CHIC



Buffet created by Chef Antoine
Hotel Le Meridien Kuala Lumpur



REVOL TOUCH COLLECTION

- 1 WIRE BASKET, RECTANGULAR GASTRO 1/1
650501 53 x 32,5 x 6,5 cm / 20 ¾ x 12 ¾ x 2 ½" ●
- 2 WIRE BASKET, SQUARE
650499 35,4 x 35,4 x 6,5 cm / 14 x 14 x 2 ½" ●
- 3 WIRE BASKET, MEDIUM RECTANGULAR
650496 29,2 x 18,2 x 8,8 cm / 11 ½ x 7 ¼ x 3 ½" ●
- 4 WIRE BASKET, LARGE RECTANGULAR
650494 32,1 x 23,9 x 15,5 cm / 12 ¾ x 9 ½ x 6" ●
- 5 WIRE DISPLAY STAND, LARGE
650667 30,7 x 25,3 x 25,3 cm / 12 x 10 x 10" ●
- 6 WIRE DISPLAY STAND, SMALL
650503 30,7 x 25,3 x 20,2 cm / 12 x 10 x 8" ●
- 7 NON SLIP ANTI SCRATCH MAT
650556 Ø 15 cm / Ø 6" ●
- 8 GLASS CLOCHE
650878 Ø 18 cm H 21 cm / Ø 7" H 8 ¼" ●
650492 Ø 27,2 cm H 24 cm / Ø 10 ¾" H 9 ½" ●
- GLASS CLOCHE & WOODEN BASE SET
650900 Ø 20 cm H 24 cm / Ø 7 ¾" H 9 ½" ●
650898 Ø 30,5 cm H 25 cm / Ø 12" H 9 ¾" ●
- 9 CLOCHE HOLDER
651034 18,4 x 22 x 46,4 cm / 7 ¼ x 8 ¾ x 18 ¼" ●

● Matt Black Metal
● Silicon
● Transparent

TIMELESS & ELEGANT

TIMELESS & ELEGANT

The "classic chic" feel is a subtle balance between refinement and simplicity. The porcelain's luminous white unifies whereas the satin black creates contrast. Through its slender lines, the metallic architecture of the displays brings structure; the cloches - in all of their transparency - enhance the dishes.



REVOL



1
648822



2



3



4
647934



645789



646321



5



CLUB COLLECTION

1 SQUARE SHALLOW DISH

- 648822 8 x 8 x 3,7 cm 8cl / 3 ¼ x 3 ¼ x 1 ½" 2 ¾ oz ○
- 648823 8 x 8 x 3,7 cm 8cl / 3 ¼ x 3 ¼ x 1 ½" 2 ¾ oz ▲
- 648808 13 x 12,5 x 4 cm 25cl / 5 x 5 x 1 ½" 8 ¾ oz ○
- 648809 13 x 12,5 x 4 cm 25cl / 5 x 5 x 1 ½" 8 ¾ oz ▲

2 SALAD BOWL 15 ¾ OZ

- 647923 14,5 x 14 x 6 cm / 5 ¾ x 5 ½ x 2 ¼" ○
- 647924 14,5 x 14 x 6 cm / 5 ¾ x 5 ½ x 2 ¼" ▲

3 SQUARE SALAD BOWL 105 ¾ OZ

- 649220 26 x 26 x 10 cm / 10 ¼ x 10 ¼ x 4" ○
- 649223 26 x 26 x 10 cm / 10 ¼ x 10 ¼ x 4" ▲

4 RECTANGULAR PLATE

- 647933 24 x 12,5 x 2,9 cm / 9 ½ x 5 x 1 ¼" ○
- 647934 24 x 12,5 x 2,9 cm / 9 ½ x 5 x 1 ¼" ▲
- 645789 36 x 15 x 2,9 cm / 14 ¼ x 6 x 1 ¼" ○
- 646319 36 x 15 x 2,9 cm / 14 ¼ x 6 x 1 ¼" ▲
- 645790 36 x 21 x 2,9 cm / 14 ¼ x 8 ¼ x 1 ¼" ○
- 646321 36 x 21 x 2,9 cm / 14 ¼ x 8 ¼ x 1 ¼" ▲

5 RECTANGULAR TRAY

- 650386 48 x 21 x 2,9 cm / 19 x 8 ¼ x 1 ¼" ○
- 650387 48 x 21 x 2,9 cm / 19 x 8 ¼ x 1 ¼" ▲



6



7



647405

9



650357



650358

REVOLUTION 2 COLLECTION

- 6 **ROUND COCOTTE 120 OZ**
649855 Ø 26 cm H 14,5 cm / Ø 10 ¼" H 5 ¾" ●

- 7 **SHALLOW COCOTTE 127 OZ**
649863 Ø 28 cm H 13,5 cm / Ø 11" H 5 ¼" ●

ALEXANDRIE COLLECTION

- 9 **RECTANGULAR ROASTING DISH**
- 616258 28 x 18,5 x 6 cm 1,75L / 11 x 7 ¼ x 2 ¼" 61 ¾ oz ○
 - 650358 28 x 18,5 x 6 cm 1,75L / 11 x 7 ¼ x 2 ¼" 61 ¾ oz ▲
 - 616259 34 x 22,5 x 6,5 cm 2,75L / 13 ½ x 8 ¾ x 2 ½" 97 oz ○
 - 650357 34 x 22,5 x 6,5 cm 2,75L / 13 ½ x 8 ¾ x 2 ½" 97 oz ▲
 - 005786 38,5 x 25 x 7 cm 4L / 15 ¼ x 9 ¾ x 2 ¾" 141 oz ○
 - 647405 38,5 x 25 x 7 cm 4L / 15 ¼ x 9 ¾ x 2 ¾" 141 oz ▲

- 10 **"BUFFET" SERVING DISH**
- 638793 32,5 x 17,6 x 3,8 cm / 12 ¾ x 7 x 1 ½" ○
 - 638792 32,5 x 26,5 x 3,8 cm / 12 ¾ x 10 ½ x 1 ½" ○
 - 003583 53 x 16,2 x 3,8 cm / 20 ¾ x 6 ½ x 1 ½" ○
 - 004345 53 x 32,5 x 3,8 cm / 20 ¾ x 12 ¾ x 1 ½" ○



8

644836



644303



10

004345

LIKID COLLECTION

- 8 **POURING JUG**
- 644303 11 x 10 x 16,2 cm 50 cl / 4 ¼ x 4 x 6 ½" 17 ¾ oz ○
 - 644387 11 x 10 x 16,2 cm 50 cl / 4 ¼ x 4 x 6 ½" 17 ¾ oz ●
 - 644837 12 x 11 x 20 cm 75cl / 4 ¾ x 4 ¼ x 7 ¾" 26 ½ oz ○
 - 644836 12 x 11 x 20 cm 75cl / 4 ¾ x 4 ¼ x 7 ¾" 26 ½ oz ●

- White
- ▲ Cast Iron Style
- Satin Black
- Slate

NORDICA

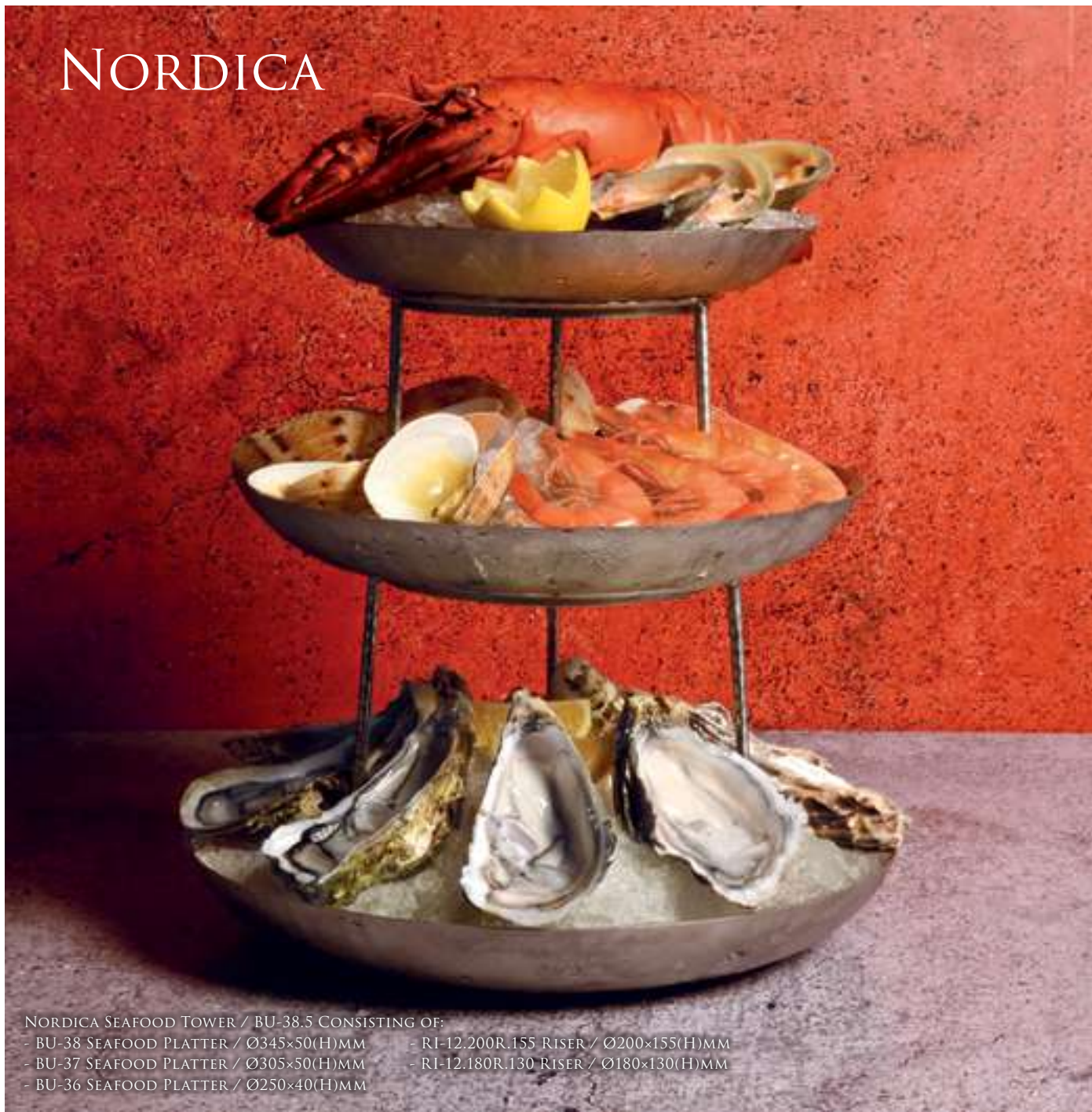

NORDICA SEAFOOD TOWER / BU-38.5 CONSISTING OF:

- BU-38 SEAFOOD PLATTER / Ø345×50(H)MM
- BU-37 SEAFOOD PLATTER / Ø305×50(H)MM
- BU-36 SEAFOOD PLATTER / Ø250×40(H)MM
- RI-12.200R.155 RISER / Ø200×155(H)MM
- RI-12.180R.130 RISER / Ø180×130(H)MM

NORDICA SEAFOOD PLATTER ^



4160100

SEAFOOD PLATTER SET, LARGE / BU-38.3 CONSISTING OF:
 -BU-38 SEAFOOD PLATTER / Ø345×50(H)MM
 -BU-37 SEAFOOD PLATTER / Ø305×50(H)MM
 -RI-12.200R.155 RISER / Ø200×155(H)MM
 (SAUCE BOWL AND SPOON NOT INCLUDED)



4160101

SEAFOOD PLATTER SET, SMALL / BU-37.3 CONSISTING OF:
 -BU-37 SEAFOOD PLATTER / Ø305×50(H)MM
 -BU-36 SEAFOOD PLATTER / Ø250×40(H)MM
 -RI-12.180R.130 RISER / Ø180×130(H)MM
 (SAUCE BOWL AND SPOON NOT INCLUDED)



ASHLEY SERVING BOARD SET



SERVING BOARD SET / TR-2201.2,
CONSISTING OF:
- SLATE PLATE / Ø250 x 8(H)MM
- WOODEN BOARD / Ø290 x 40(H)MM



SERVING BOARD SET / TR-2202.2,
CONSISTING OF:
- SLATE PLATE / Ø300 x 8(H)MM
- WOODEN BOARD / Ø340 x 40(H)MM



SERVING BOARD SET / TR-2203.2,
CONSISTING OF:
- SLATE PLATE / Ø350 x 8(H)MM
- WOODEN BOARD / Ø390 x 40(H)MM



ASHLEY

PADDLE BOARDS WITH HANDY DESIGN.
MADE OF WARM ACACIA, DEVOTED TO
THE BEST PRESENTATION OF TAPAS AND PLATTERS.

PADDLE SERVING BOARD



CB-86/ 500x160x18(H)MM



CB-85/ 400x140x18(H)MM



CB-84/ 330x120x15(H)MM



CB-90/ 700x200x20(H)MM



CB-92/ Ø350x22(H)MM



CB-91/ Ø250x18(H)MM

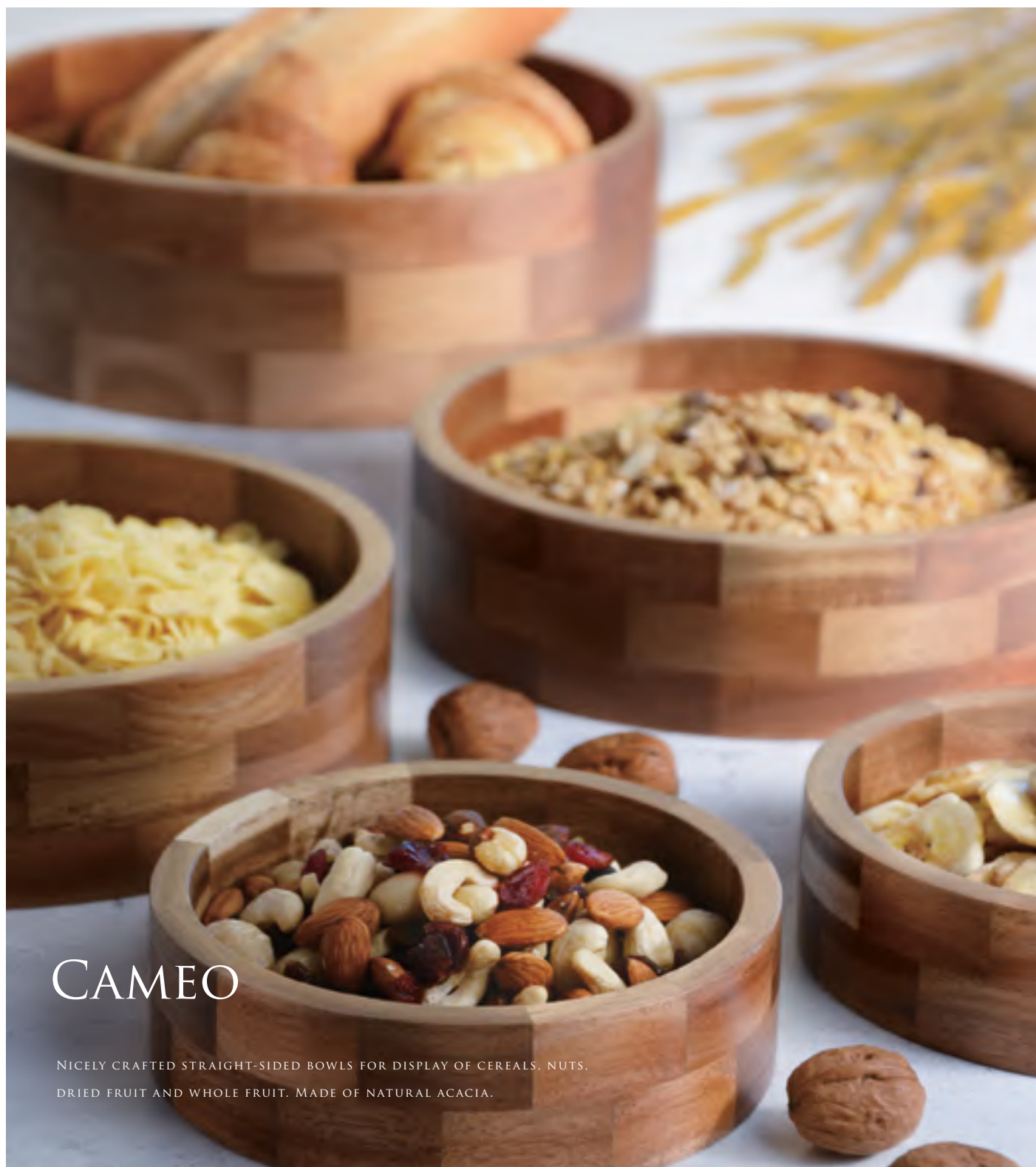

CAMEO

NICELY CRAFTED STRAIGHT-SIDED BOWLS FOR DISPLAY OF CEREALS, NUTS, DRIED FRUIT AND WHOLE FRUIT. MADE OF NATURAL ACACIA.

CAMEO WOODEN BOWL



BU-51/ Ø160×60(H)MM



BU-52/ Ø230×90(H)MM



BU-53/ Ø275×110(H)MM

CAMEO

ACACIA TRAYS IN WARM COLOR WITH CLOCHES TO PRESENT AROMATIC
MACARON, SWEET AND PETIT FOUR.



CAMEO ROUND TRAY W/ LID



FEATURING:

- ❶ TR-20.182R ROUND TRAY /
Ø182x22(H)MM
- ❷ VD-65294 GLASS DOME COVER/
Ø160x140(H)MM



FEATURING:

- ❶ TR-20.252R ROUND TRAY /
Ø252x30(H)MM
- ❷ VD-65295 GLASS DOME COVER/
Ø230x165(H)MM



FEATURING:

- ❶ TR-20.300R ROUND TRAY /
Ø300 x 40(H)MM
- ❷ VD-65296 GLASS DOME COVER/
Ø275x205(H)MM



CASSANDRA

CASSANDRA TURNED THE COMMON FORM OF CAKE PLATE INTO A BUNCH OF LOVELY WOODEN MUSHROOMS STANDING HIGH AND LOW FOR CAKES, SWEETS, CHOCOLATES AND MACARONS. MATCHING GLASS DOMES AVAILABLE.

CASSANDRA CAKE STAND



FEATURING: 4161001
 ① RI-15.180R.100 CAKE STAND/
 Ø180x100(H)MM
 ② VD-65294 GLASS DOME COVER/
 Ø160x140(H)MM 4161101



FEATURING: 4161002
 ① RI-15.250R.150 CAKE STAND/
 Ø250x150(H)MM
 ② VD-65295 GLASS DOME COVER/
 Ø230x165(H)MM 4161102



FEATURING: 4161003
 ① RI-15.295R.200 CAKE STAND/
 Ø295x200(H)MM
 ② VD-65296 GLASS DOME COVER/
 Ø275x205(H)MM 4161103

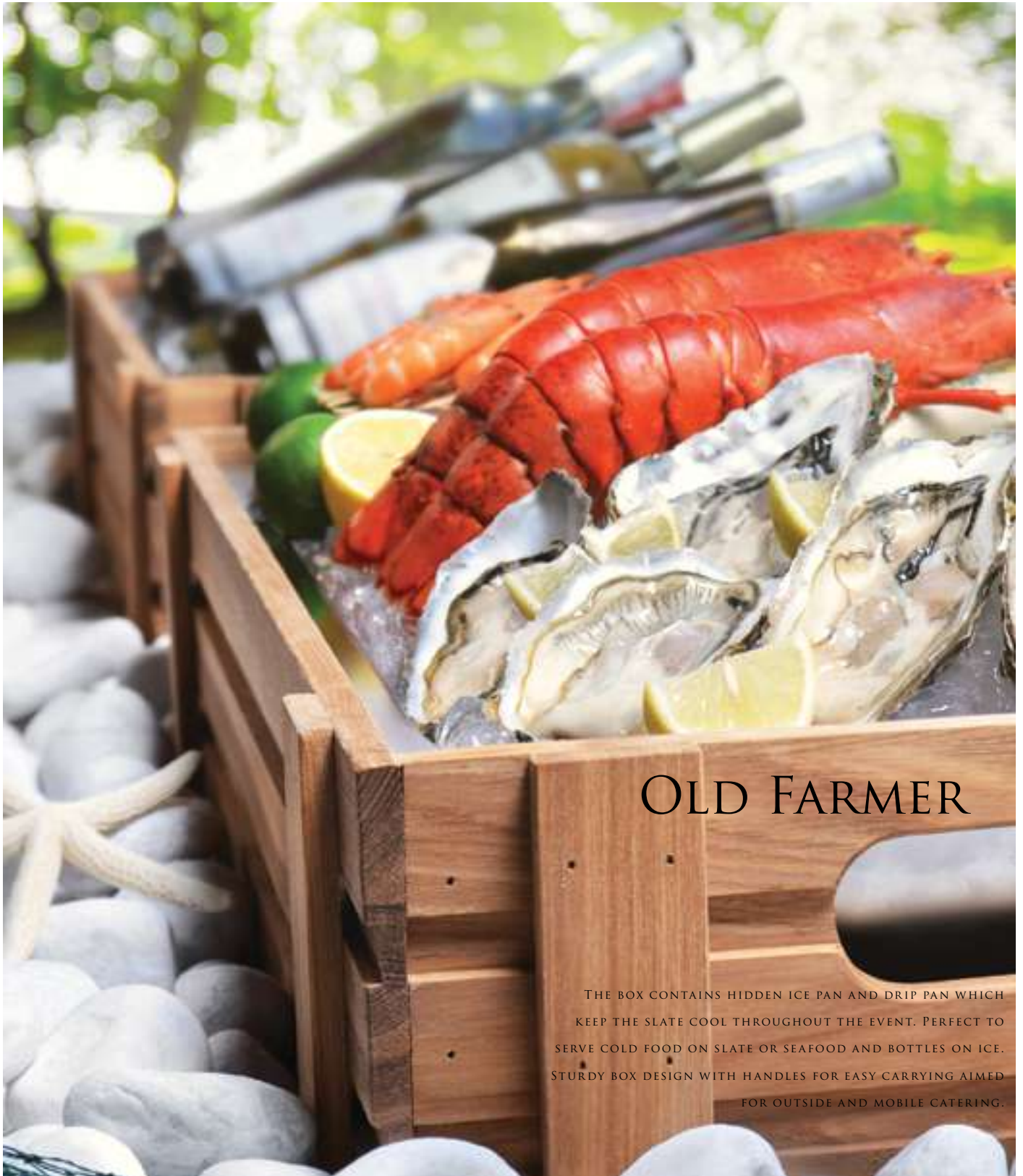

OLD FARMER

THE BOX CONTAINS HIDDEN ICE PAN AND DRIP PAN WHICH KEEP THE SLATE COOL THROUGHOUT THE EVENT. PERFECT TO SERVE COLD FOOD ON SLATE OR SEAFOOD AND BOTTLES ON ICE. STURDY BOX DESIGN WITH HANDLES FOR EASY CARRYING AIMED FOR OUTSIDE AND MOBILE CATERING.

OLD FARMER COLD DISPLAY BOX / CDB-811.BOX, CONSISTING OF:



WOODEN BOX /
550 x 355 x 150(H)MM



S/S DRIP TRAY



S/S ICE PAN / GN 1/1



NATURAL SLATE PLATE/
530x330x8(H)MM



OLD FARMER COLD DISPLAY BOX / CDB-812.BOX, CONSISTING OF:



WOODEN BOX /
350 X 285 X 150(H)MM



S/S DRIP TRAY



S/S ICE PAN / GN 1/2



NATURAL SLATE PLATE /
325 X 265 X 8(H)MM





CASPER MERCHANT BOX

THE RANGE OFFERS TRAYS & RISERS IN DIFFERENT SIZES.
BY STACKING UP YOUR DESIRED SIZE AND HEIGHT,
YOUR UNIQUE COMBINATION IS FORMED.
HIGHLY FLEXIBLE & ADAPTABLE. MADE WITH NATURAL
ASH WOOD.

TRAY - UPWARDS



4160401

TR-1601-AS/ 180x180x75(H)MM



BREAD BASKET



CONDIMENT TRAY

TRAY - DOWNWARDS



4160401

TR-1601-AS/ 180x180x75(H)MM



DISPLAYER FOR BUTTER BOWL

TRAY - UPWARDS



TR-1602-AS/ 425x145x60(H)MM

4160402



HONEY & JAM TRAY

TRAY - DOWNWARDS



TR-1602-AS/ 425x145x60(H)MM

4160402



DISPLAYER FOR CEREAL BOWLS

RISER WITH NATURAL SLATE ^

1



2



1 NS-400120.08/ 400x120x8(H)MM 4161403

2 TR-1602RI-AS/ 425x145x60(H)MM 4160403



DISPLAYER FOR PICKLE BOWLS

STACKING UP TO DESIRED HEIGHT

1



2



1 TR-1602-AS/ 425x145x60(H)MM 4160402

2 TR-1602RI-AS/ 425x145x60(H)MM 4160403



DISPLAYER FOR CEREAL BOWLS

STACKING UP TO DESIRED HEIGHT

1



2



3



1 2 TR-1602RI-AS/ 425x145x60(H)MM 4160403

3 TR-1602-AS/ 425x145x60(H)MM 4160402



DRINKS STATION

TRAY - UPWARDS



TR-1603-AS/ 325×325×60(H)MM

4160404



BREAD TRAY

TRAY - DOWNWARDS



TR-1603-AS/ 325×325×60(H)MM

4160404



DISPLAYER FOR FRUIT PLATE

RISER WITH NATURAL SLATE ^



- ① NS-300300.08/300×300×8(H)MM 4161408
- ② TR-1603RI-AS/325×325×60(H)MM 4160405



DISPLAYER FOR CHEESE

STACKING UP TO DESIRED HEIGHT



- ① TR-1603-AS/ 325×325×60(H)MM 4160404
- ② TR-1603RI-AS/325×325×60(H)MM 4160405



DISPLAYER FOR FRUIT PLATE

STACKING UP TO DESIRED HEIGHT



- ① ③ ④ TR-1603RI-AS/ 325×325×60(H)MM 4160405
- ② TR-1603-AS/ 325×325×60(H)MM 4160404



TROPICAL FRUIT BOX

^ NATURAL SLATE IS A HAND CRAFTED PRODUCT, ABOVE SIZES AND THICKNESSES MAY VARY.

TRAY - UPWARDS



TR-1604-AS/ 525x325x73(H)MM 4160406



FRUIT TRAY

TRAY - DOWNWARDS



TR-1604-AS/ 525x325x73(H)MM 4160406



DISPLAYER FOR WET MARKET

RISER WITH NATURAL SLATE ^



NS-500300.08/ 500x300x8(H)MM 4161411
TR-1604RI-AS/ 525x325x73(H)MM 4160407



DISPLAYER FOR COLD CUT

STACKING UP TO DESIRED HEIGHT



TR-1604-AS/ 525x325x73(H)MM 4160406
TR-1604RI-AS/ 525x325x73(H)MM 4160407



DISPLAYER FOR WET MARKET

STACKING UP TO DESIRED HEIGHT



TR-1604RI-AS/ 525x325x73(H)MM 4160407
TR-1604-AS/ 525x325x73(H)MM 4160406



BREAD BOX

^ NATURAL SLATE IS A HAND CRAFTED PRODUCT. ABOVE SIZES AND THICKNESSES MAY VARY.

OLD FARMER

INSPIRED BY FRESH MARKET, OLD FARMER MERCHANT BOX RESEMBLES THE FORM OF FOOD DISPLAY THAT BRINGS THE NATURAL COLORS AND THE ESSENTIAL RUSTIC TOUCH TO THE BUFFET TABLE.

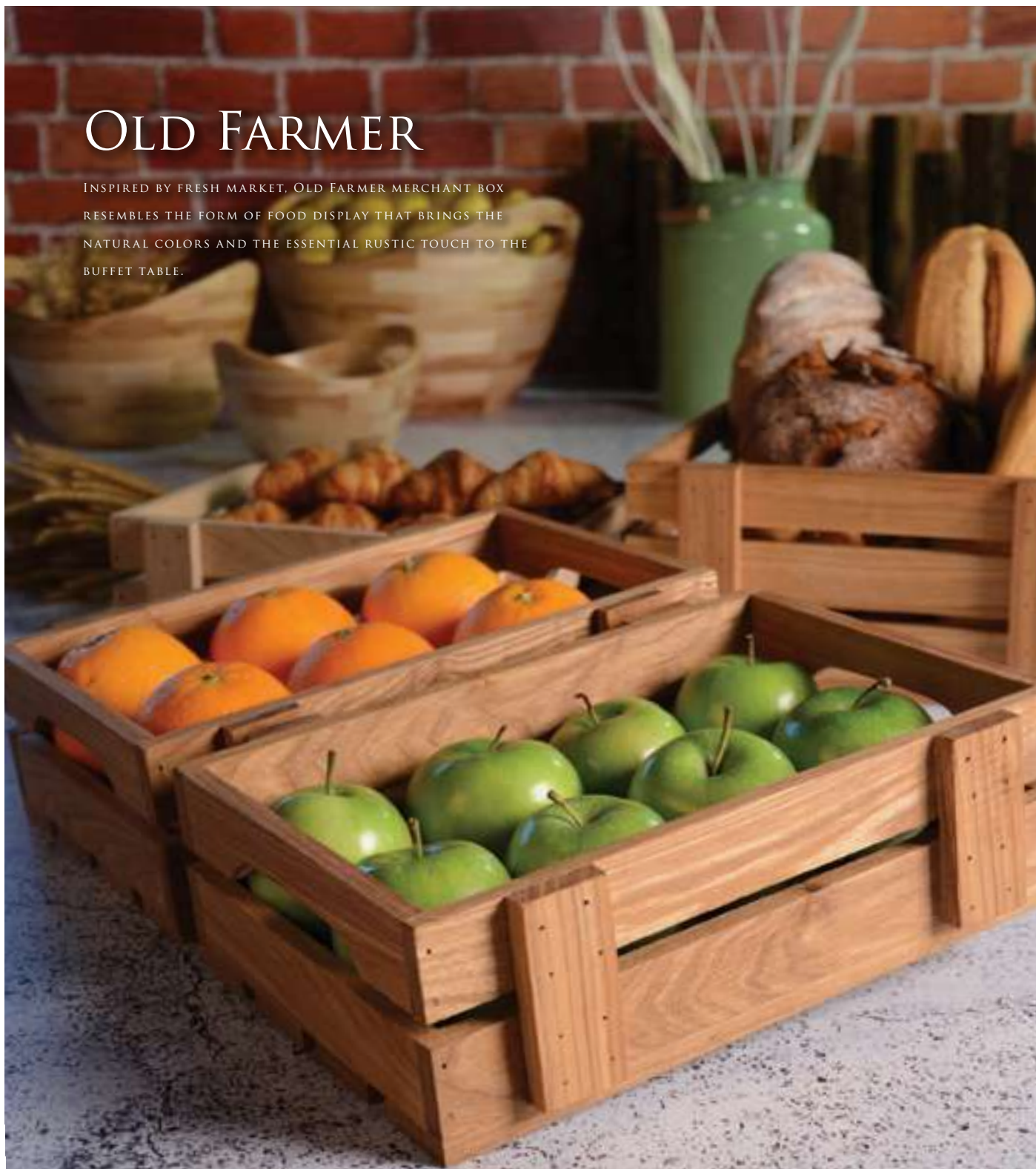

OLD FARMER MERCHANT BOX



4162101

RI-06.300200.90/ 300×200×90(H)MM



4162102

RI-06.300300.135/ 300×300×135(H)MM



4162103

RI-06.400300.150/ 400×300×150(H)MM

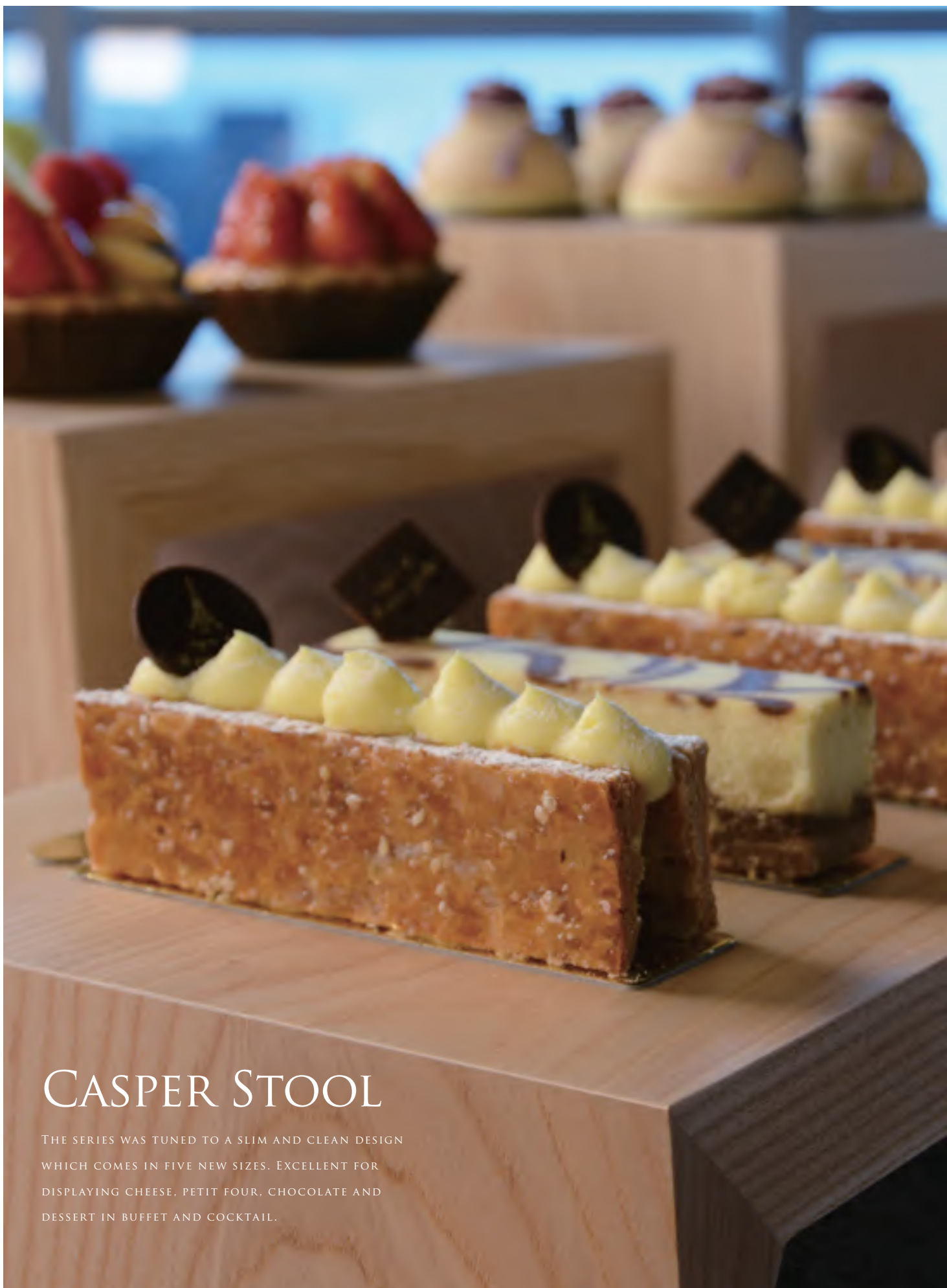

CASPER STOOL

THE SERIES WAS TUNED TO A SLIM AND CLEAN DESIGN WHICH COMES IN FIVE NEW SIZES. EXCELLENT FOR DISPLAYING CHEESE, PETIT FOUR, CHOCOLATE AND DESSERT IN BUFFET AND COCKTAIL.



CASPER WOODEN STOOL



RI-14.200200.90/ 200×200×90(H)MM 4160501



RI-14.200200.150/ 200×200×150(H)MM 4160502



4160503
RI-14.250250.60/ 250×250×60(H)MM



4160504
RI-14.250250.120/ 250×250×120(H)MM



4160505
RI-14.400200.60/ 400×200×60(H)MM

CASPER BOARD



4160506
CB-64-AS/ 400×200×24(H)MM



4160507
CB-78-AS/ Ø254×24(H)MM



4160508
CB-65-AS/ 500×200×24(H)MM



4160509
CB-66-AS/ 700×200×24(H)MM



4160510
CB-59/ 530×370×40(H)MM

ART DE GOURMET I

IT IS A NEW LINE FOR FOOD SERVING & BUFFET SETTING.

IT COMES IN A RANGE OF FOOD SAFE-LAMINATED NATURAL SLATE

IN DIFFERENT SIZES PERFECT FOR PETIT FOUR, TASTING MENU,

SNACKS & SUSHI...

THE RANGE ALSO GOES ALONG WITH MATCHING RISER STANDS

IN HEAVY GAUGE STAINLESS STEEL TO CREATE A STRAIGHT FORWARD

BUT NOT OVERWHELMING AID FOR FOOD ART PRESENTATION.



NATURAL SLATE PLATE ^



4161401

NS-200100.08/ 200×100×8MM



4161402

NS-300120.08/ 300×120×8MM



4161403

NS-400120.08/ 400×120×8MM



4161404

NS-250R.08/ Ø250×8MM



4161405

NS-300R.08/ Ø300×8MM



4161406

NS-350R.08/ Ø350×8MM



4161407

NS-200200.08/ 200×200×8MM



4161408

NS-300300.08/ 300×300×8MM



4161409

NS-300200.08/ 300×200×8MM



4161410

NS-400250.08/ 400×250×8MM



4161411

NS-500300.08/ 500×300×8MM

^ NATURAL SLATE IS A HAND CRAFTED PRODUCT, ABOVE SIZES AND THICKNESSES MAY VARY

STAINLESS STEEL RISER STAND



4161501

RI-01.180180.30/
180×180×30(H)MM



4161502

RI-01.180180.120/
180×180×120(H)MM



4161503

RI-01.180180.180/
180×180×180(H)MM



4161504

RI-01.180180.240/
180×180×240(H)MM



4161505

RI-01.120120.30/
120×120×30(H)MM



4161506

RI-01.120120.80/
120×120×80(H)MM



4161507

RI-01.120120.120/
120×120×120(H)MM



4161508

RI-01.120120.160/
120×120×160(H)MM



4161509

RI-01.120120.240/
120×120×240(H)MM

ART DE GOURMET I

COMBINED DISPLAY SET



PYRAMID IV/ ADG-SET A, CONSISTING OF:

NATURAL SLATE

- ① NS-300120.08 / 300×120×8MM
- ② NS-200200.08 / 200×200×8MM
- ③ NS-300300.08 / 300×300×8MM
- ④ NS-500300.08 / 500×300×8MM

STAINLESS STEEL RISER STAND

- ⑤ RI-01.120120.30 / 120×120×30(H)MM
- ⑥ 2PCS OF RI-01.120120.80 / 120×120×80(H)MM
- ⑦ 2PCS OF RI-01.180180.30 / 180×180×30(H)MM
- ⑧ RI-01.180180.180 / 180×180×180(H)MM

STEPS III/ ADG-SET B, CONSISTING OF:

NATURAL SLATE

- ① 3PCS OF NS-400120.08 / 400×120×8MM

STAINLESS STEEL RISER STAND

- ② 2PCS OF RI-01.120120.30 / 120×120×30(H)MM
- ③ 2PCS OF RI-01.120120.120 / 120×120×120(H)MM
- ④ 2PCS OF RI-01.120120.240 / 120×120×240(H)MM



EXECUTIVE VI/ ADG-SET C, CONSISTING OF:

NATURAL SLATE

- ① 2PCS OF NS-400120.08 / 400×120×8MM
- ② NS-400250.08 / 400×250×8MM
- ③ NS-500300.08 / 500×300×8MM
- ④ NS-300R.08 / Ø300×8MM
- ⑤ NS-350R.08 / Ø350×8MM

STAINLESS STEEL RISER STAND

- ⑥ 2PCS OF RI-01.120120.30 / 120×120×30(H)MM
- ⑦ 2PCS OF RI-01.120120.120 / 120×120×120(H)MM
- ⑧ 2PCS OF RI-01.120120.240 / 120×120×240(H)MM
- ⑨ 3PCS OF RI-01.180180.30 / 180×180×30(H)MM
- ⑩ RI-01.180180.180 / 180×180×180(H)MM



DIAMOND VI/ ADG-SET D, CONSISTING OF:
NATURAL SLATE

- ① 3PCS OF NS-200200.08 / 200×200×8MM
- ② 3PCS OF NS-300300.08 / 300×300×8MM

STAINLESS STEEL RISER STAND

- ③ 3PCS OF RI-01.120120.30 / 120×120×30(H)MM
- ④ 3PCS OF RI-01.180180.120 / 180×180×120(H)MM

CRESENT V/ ADG-SET F, CONSISTING OF:
NATURAL SLATE

- ① 5PCS OF NS-300R.08 / Ø300×8MM

STAINLESS STEEL RISER STAND

- ② 2PCS OF RI-01.180180.30 / 180×180×30(H)MM
- ③ 2PCS OF RI-01.180180.120 / 180×180×120(H)MM
- ④ RI-01.180180.180 / 180×180×180(H)MM



CRESENT VII/ ADG-SET G, CONSISTING OF:
NATURAL SLATE

- ① 3PCS OF NS-300R.08 / Ø300×8MM
- ② 4PCS OF NS-350R.08 / Ø350×8MM

STAINLESS STEEL RISER STAND

- ③ 2PCS OF RI-01.180180.30 / 180×180×30(H)MM
- ④ 2PCS OF RI-01.180180.120 / 180×180×120(H)MM
- ⑤ 2PCS OF RI-01.180180.180 / 180×180×180(H)MM
- ⑥ RI-01.120120.240 / 120×120×240(H)MM

^ NATURAL SLATE IS A HAND CRAFTED PRODUCT, ABOVE SIZE AND THICKNESS MAY VARY



ART DE GOURMET III

ADG III IS UPGRADED TO ANSWER THE NEEDS OF COLD FOOD DISPLAY. INSIDE THE WOODEN BOX THERE IS A SET OF ICE PACK TO KEEP THE SLATE AT EVEN AND LOW TEMPERATURE FOR BEST SERVING OF HAM, CHEESE, SUSHI, SALAD AND FRUIT. HI-LOW HANDY DESIGN ENABLES UNLIMITED COMBINATION AND FORMS OF DISPLAY - MOBILE AND VOLATILE.

ART DE GOURMET III COLD DISPLAY SET



- ① NS-180180.08 NATURAL SLATE/ 180×180×8(H)MM
- ② ICG-01 ICE GEL BOX/ 150×150×30(H)MM
- ③ IDT-01.180180.50 DRIP TRAY/ 180×180×50(H)MM
- ④ TR-19.200200.78 WOODEN BOX/ 200×200×78(H)MM
- ⑤ RI-01.200200.60-CHO S/S RISER, CHOCO COLOUR/ 200×200×60(H)MM
- ⑥ RI-01.200200.128-CHO S/S RISER, CHOCO COLOUR/ 200×200×128(H)MM
- ⑦ RI-01.200200.196-CHO S/S RISER, CHOCO COLOUR/ 200×200×196(H)MM
- ⑧ RI-01.200200.264-CHO S/S RISER, CHOCO COLOUR/ 200×200×264(H)MM



ART DE GOURMET III COLD DISPLAY SET



- ① NS-280280.08 NATURAL SLATE/ 280×280×8(H)MM
- ② ICG-02 ICE GEL BOX/ 250×125×30(H)MM
- ③ IDT-01.280280.50 DRIP TRAY/ 280×280×50(H)MM
- ④ TR-19.300300.78 WOODEN BOX/ 300×300×78(H)MM
- ⑤ RI-01.300300.60-CHO S/S RISER, CHOCO COLOUR/ 300×300×60(H)MM
- ⑥ RI-01.300300.128-CHO S/S RISER, CHOCO COLOUR/ 300×300×128(H)MM
- ⑦ RI-01.300300.196-CHO S/S RISER, CHOCO COLOUR/ 300×300×196(H)MM
- ⑧ RI-01.300300.264-CHO S/S RISER, CHOCO COLOUR/ 300×300×264(H)MM



ART DE GOURMET III

ADG III IS ALSO GOOD FOR DISPLAY OF PASTRY.
NATURAL WARM COLOR OF ACACIA ALWAYS REMINDS
YOU THE UNFORGETTABLE AROMA OF HOMEMADE BREAD AND BUNS.
HI-LOW HANDY DESIGN ENABLES UNLIMITED COMBINATION AND FORMS OF
DISPLAY - MOBILE AND VOLATILE.



ART DE GOURMET III DISPLAY SET



- ① TR-19.200200.78 WOODEN BOX/ 200×200×78(H)MM
- ② RI-01.200200.60-CHO S/S RISER,
CHOCO COLOUR/ 200×200×60(H)MM
- ③ RI-01.200200.128-CHO S/S RISER,
CHOCO COLOUR/ 200×200×128(H)MM
- ④ RI-01.200200.196-CHO S/S RISER,
CHOCO COLOUR/ 200×200×196(H)MM
- ⑤ RI-01.200200.264-CHO S/S RISER,
CHOCO COLOUR/ 200×200×264(H)MM

ART DE GOURMET III DISPLAY SET



- ① TR-19.300300.78 WOODEN BOX/ 300×300×78(H)MM
- ② RI-01.300300.60-CHO S/S RISER,
CHOCO COLOUR/ 300×300×60(H)MM
- ③ RI-01.300300.128-CHO S/S RISER,
CHOCO COLOUR/ 300×300×128(H)MM
- ④ RI-01.300300.196-CHO S/S RISER,
CHOCO COLOUR/ 300×300×196(H)MM
- ⑤ RI-01.300300.264-CHO S/S RISER,
CHOCO COLOUR/ 300×300×264(H)MM

CASA

SHAPED BEAUTIFULLY, CASA WOODEN BOWLS WILL DEFINITELY ADD ATTRACTION TO YOUR CEREALS AND FRUITS DISPLAY. THREE SIZES AVAILABLE FOR FLEXIBLE COMBINATION OF SERVING.

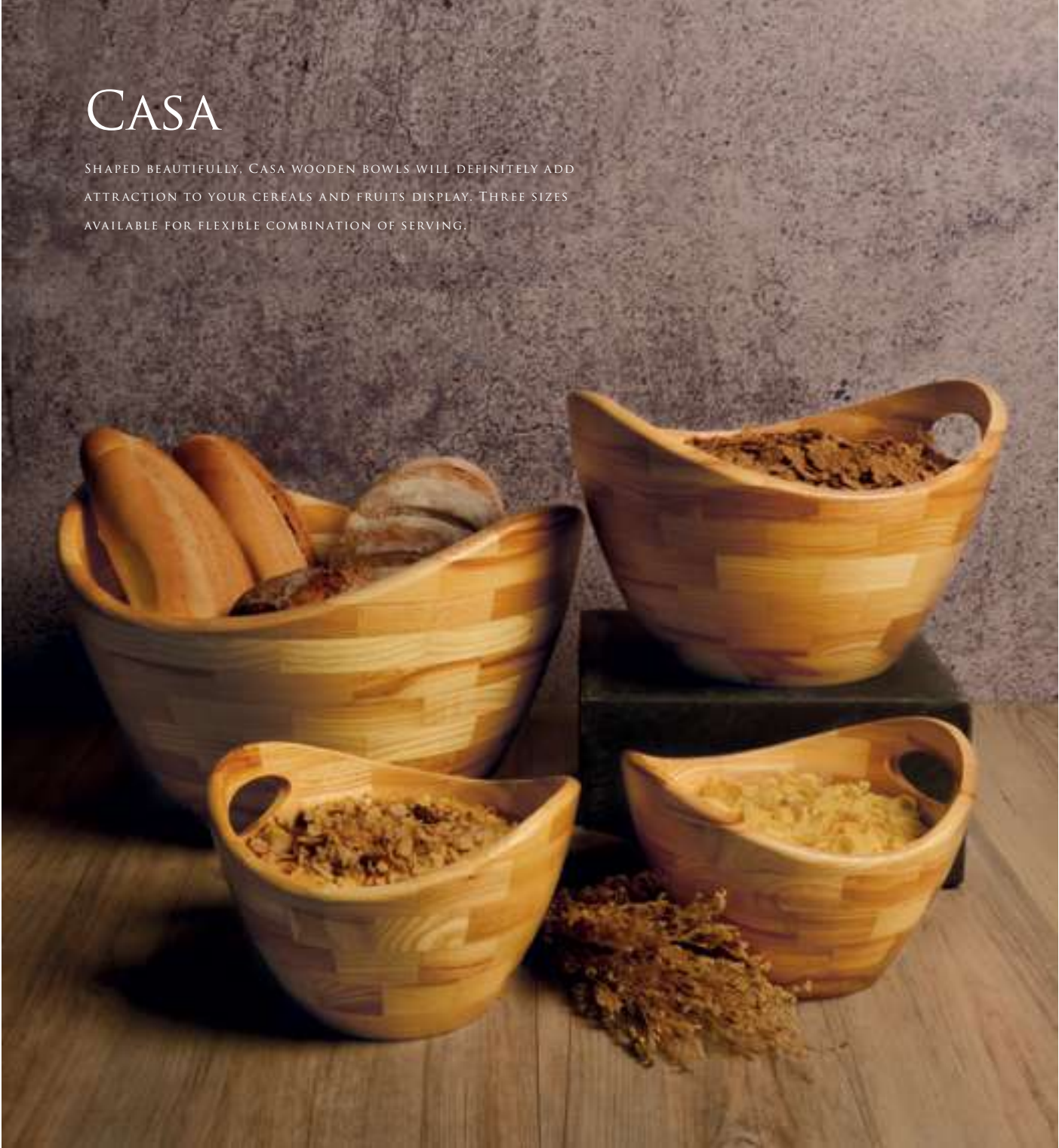

CASA WOODEN BOWL



4160801

BU-33/ 200×185×130(H)MM



4160802

BU-34/ 280×265×180(H)MM



4160803

BU-35/ 360×340×225(H)MM

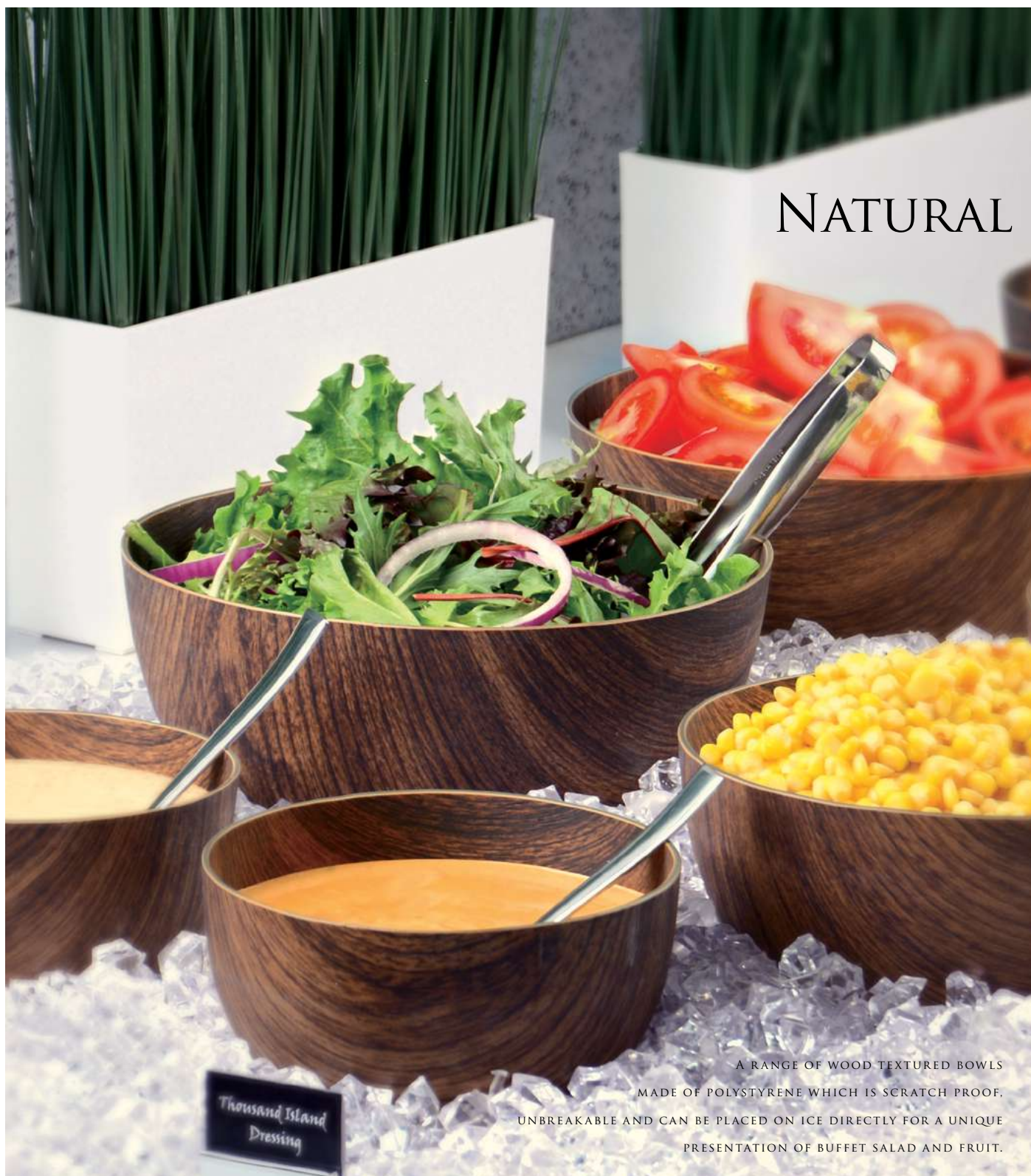

NATURAL UNIVERSAL BOWL



EL-10182/
Ø160×85(H)MM



EL-10183/
Ø200×95(H)MM



EL-10184/
Ø240×105(H)MM



EL-10161/
Ø310×80(H)MM



EL-10187/
360×240×85(H)MM



DRAKE

DRAKE 3-TIERS DISPLAYER HAS A COMPACT DESIGN AS A SET OF DRAWERS YET FLEXIBLE TO BE FREE STANDING TO CREATE AN EYE-CATCHING CORNER. PERFECT FOR DISPLAYING BREADS, PASTRY AND FRUITS.

DRAKE 3 TIERS DISPLAYER SET ^



4160901

3 TIERS DISPLAYER SET, SMALL/ RI-11.250250.SET3

CONSISTING OF:

- ① RI-11.250250.250/ 250×250×250(H)MM
- ② RI-11.250220.165/ 250×220×165(H)MM
- ③ RI-11.250190.80/ 250×190×80(H)MM



4160902

3 TIERS DISPLAYER SET, LARGE/ RI-11.325325.SET3

CONSISTING OF:

- ① RI-11.325325.325/ 325×325×325(H)MM
- ② RI-11.325285.215/ 325×285×215(H)MM
- ③ RI-11.325245.105/ 325×245×105(H)MM

^ MAKE-TO-ORDER ITEM REQUIRING A LONGER PRODUCTION LEADTIME, PLEASE CHECK WITH YOUR LOCAL DISTRIBUTOR FOR MORE INFORMATION.

REECE MINI TUREEN & STAND

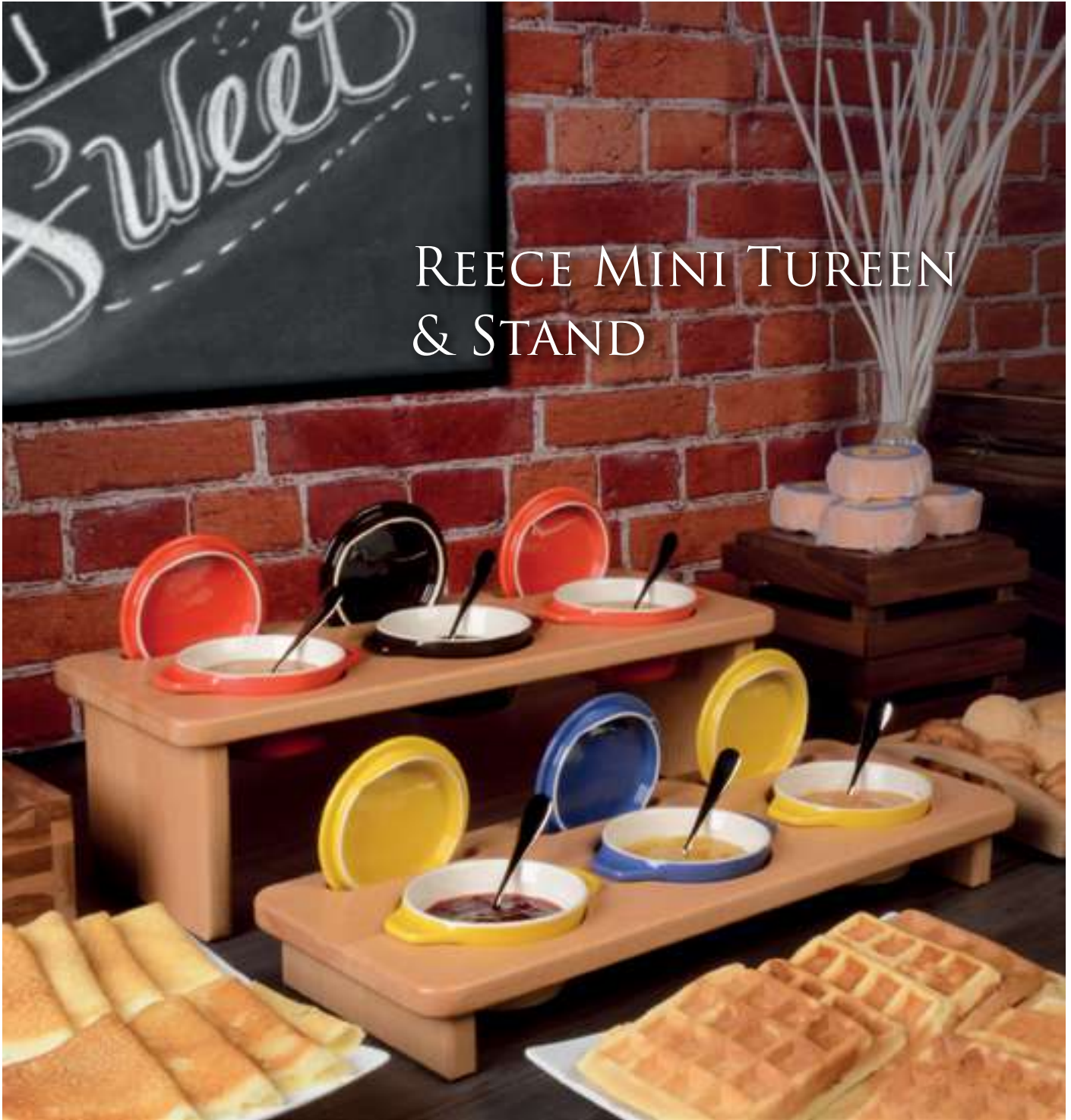

REECE MINI TUREEN STAND

REECE MINI TUREEN/ Ø100×85(H)MM 0.20L



1

2

FEATURING:

4160702

① RI-13.486180.145 WOODEN STAND/ 486×180×145(H)MM

4160703

② RI-13.486180.58 WOODEN STAND/ 486×180×58(H)MM



CW-501-CHO/ CHOCOLATE



CW-501-COB/ COBALT



CW-501-YEL/ YELLOW



CW-501-RED/ RED

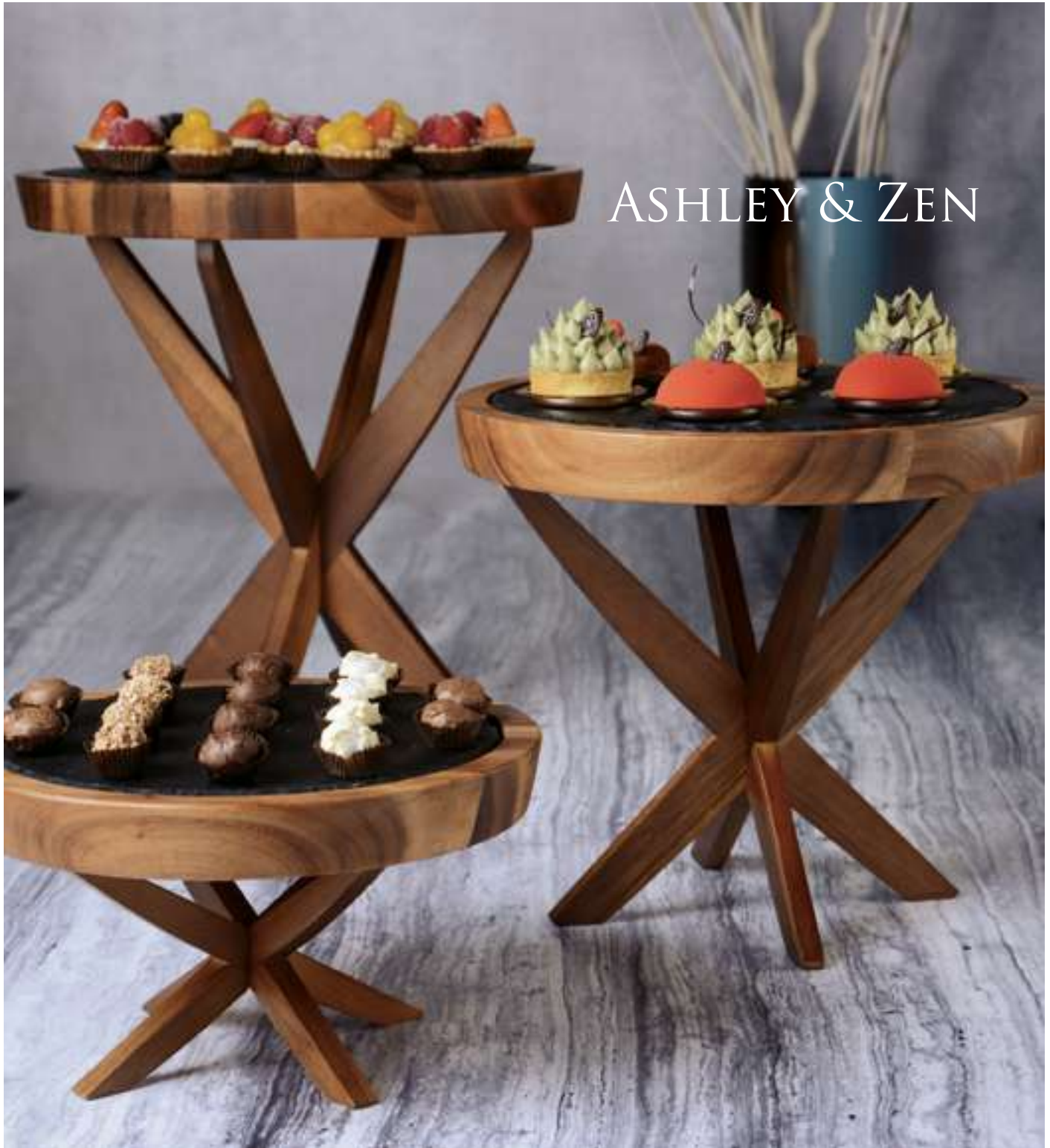

ASHLEY SERVING BOARD & ZEN RISER



FEATURING:

- ① TR-2201.2 / SERVING BOARD SET
- SLATE PLATE / Ø250 x 8(H)MM
- WOODEN BOARD / Ø290 x 40(H)MM
- ② RI-10.235235.135 / ZEN RISER
235x235x135(H)MM



FEATURING:

- ① TR-2202.2 / SERVING BOARD SET
- SLATE PLATE / Ø300 x 8(H)MM
- WOODEN BOARD / Ø340 x 40(H)MM
- ② RI-10.280280.270 / ZEN RISER
280x280x270(H)MM



FEATURING:

- ① TR-2203.2 / SERVING BOARD SET
- SLATE PLATE / Ø350 x 8(H)MM
- WOODEN BOARD / Ø390 x 40(H)MM
- ② RI-10.330330.380 / ZEN RISER
330 x 330 x 380(H)MM



ZEN

ZEN RISER HAS A SLIM AND DAINTY SHAPE WHICH STANDS ALONG WELL WITH MOST KINDS AND SIZES OF PLATES. IT CAN BE STOOD BOTH WAYS TO CREATE THE BEST MATCHING VISUAL WITH THE SHAPE OF PLATE AND FOOD.

ZEN RISER



4161201

RI-10.235235.135/
235×235×135(H)MM
REVERSIBLE DESIGN



4161202

RI-10.280280.270/
280×280×270(H)MM
REVERSIBLE DESIGN



4161203

RI-10.330330.380/
330×330×380(H)MM
REVERSIBLE DESIGN

CASPER

CASPER RANGE DESIGNER SHELF OFFERS A 2-TIERS AND A 5-TIERS VERSION PERFECT FOR DISPLAYING BREADS, FRUITS, MAGAZINES, GUEST AMENITIES AND MANY MORE. IT CAN BE APPLIED TO BUFFET, ALL DAY DINNING, GUEST CORNER OR RESTING AREA. EACH SHELF BOARD CAN BE ADJUSTED TO STAY HORIZONTALLY OR SLANTED DEPENDING ON YOUR NEED. NATURAL ASH CONSTRUCTION, STURDY AND DURABLE.



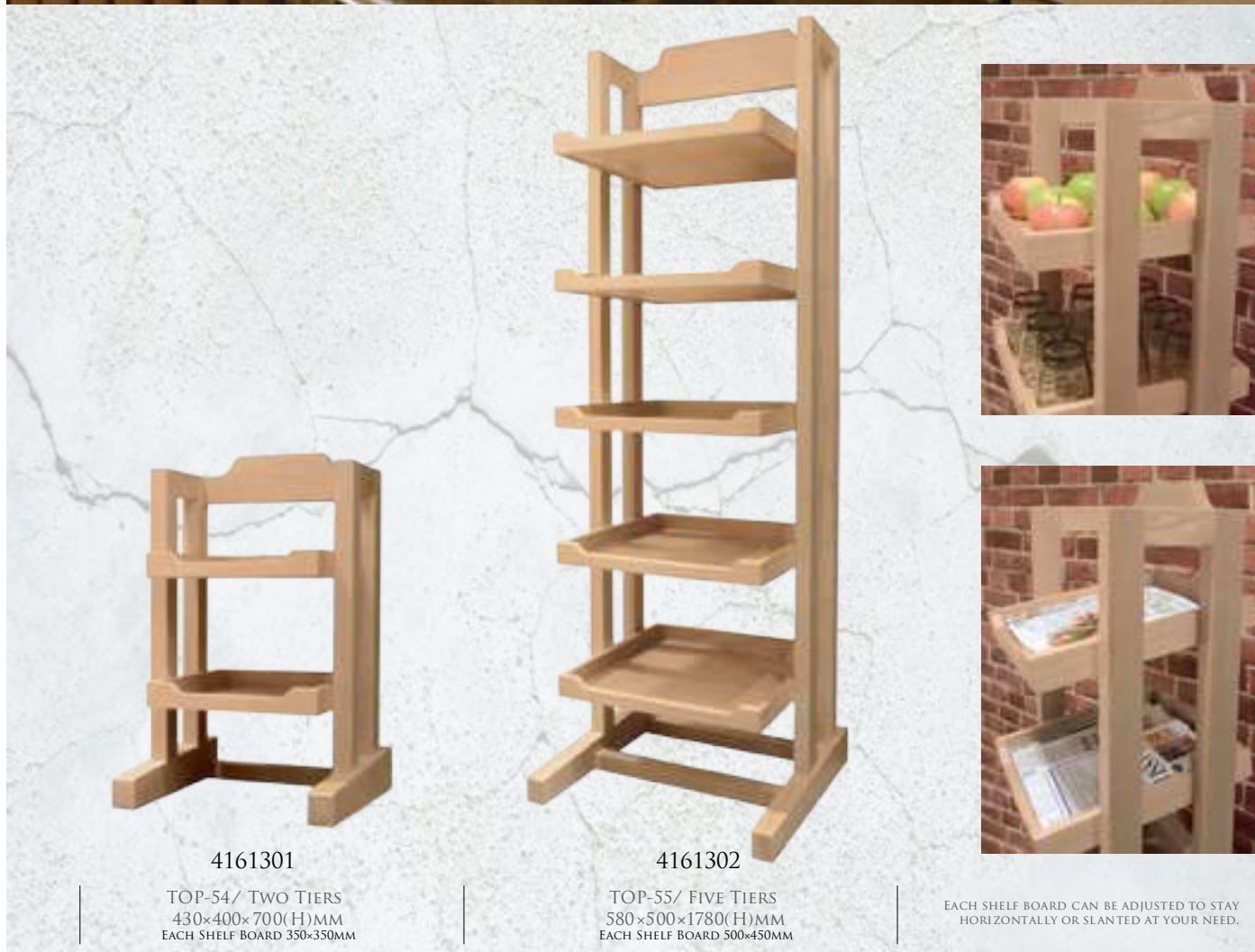

4161301

TOP-54 / TWO TIERS
430×400×700(H)MM
EACH SHELF BOARD 350×350MM

4161302

TOP-55 / FIVE TIERS
580×500×1780(H)MM
EACH SHELF BOARD 500×450MM

EACH SHELF BOARD CAN BE ADJUSTED TO STAY HORIZONTALLY OR SLANTED AT YOUR NEED.



ROSANE & ZOIE

JUICE BOTTLE AND PUDDING BOTTLE RESEMBLE THE SIZE AND SHAPE POPULAR IN THE RETAIL MARKET. SMALLER PORTION MEANS LESS WASTAGE AT BUFFET. REUSABLE CAP AVAILABLE FOR ROSANE, WHILE ZOIE JUICE BOTTLE IS FEATURED WITH SWING CAP WASHABLE FOR REUSE.

ROSANE JUICE BOTTLE
W/ REUSABLE CAP



GW-308.18/ 0.18L

ROSANE PUDDING BOTTLE
W/ REUSABLE CAP



GW-309.08/ 0.08L

ZOIE GOURMET BOTTLE
W/ SWING CAP



GW-302.25/ 200(H)MM 0.25L



ZOIE

NUTS AND DRIED FRUIT CAN NOW BE KEPT FRESH AND CRUNCHY BY THE SMARTLY DESIGNED LID. GUEST CAN NOW ENJOY HIS OWN MIXED YOGURT.

ZOIE YOGURT BOTTLE W/ WOODEN LID



GW-311/ Ø70x85(H)MM. CAP 0.13L



GW-310/ Ø90x100(H)MM, CAP 0.21L

HORIZON & LUNA

SPECIALLY DESIGNED FOR BEST PRESENTATION OF FINE FOOD IN BUFFET.



HORIZON DOUBLE WALL GOURMET GLASS

Handmade



GDG-06.04/ 0.04L



GDG-06.08/ 0.08L



GDG-06.18/ 0.18L

LUNA DOUBLE WALL GOURMET GLASS

Handmade



GDG-05.04/ 0.04L



GDG-05.08/ 0.08L



GDG-05.18/ 0.18L

BUFFET ESSENTIALS

THE NECESSARY SUPPLEMENTS TO COMPLETE THE PERFECT BUFFET SETTING

BUFFET TAG HOLDER



REECE MINI TUREEN/ Ø100×85(H)MM 0.2L



UNIVERSAL BOWL/ Ø123×72(H)MM



FEATURING:

4161901

GH-18 APPLE TREE/
① 540×590(H)MM

4161902

② GH-35 APPLE TREE, MINI/
320×285(H)MM



4161801

FEATURING:

- ① BU-22 DORF DESSERT STAND/
445×68×55(H)MM
- ② 6PCS OF GSG-03.10 DESSERT GLASS/ 0.1L



4160244

CASSANDRA DELUXE PUNCH BOWL
BW-19/ Ø440×305(H)MM



FEATURING:

4162001

① BU-25 CASSANDRA UNIVERSAL BOWL/
Ø140×70(H)MM

4162002

② BU-26 CASSANDRA UNIVERSAL BOWL/
Ø220×103(H)MM

4162003

③ BU-27 CASSANDRA UNIVERSAL BOWL/
Ø360×180(H)MM



FEATURING:

- ① TOP-32 3 TIERS STAND/
286×256×513(H)MM
- ② NS-360160.08
NATURAL SLATE PLATE/
360×160×8MM

MORE COLOUR
CHOICE:



TOP-32-BLK/ BLACK



CROWN BREAD / FRUIT BASKET
GH-05/ Ø320×170(H)MM



Double Wall Insulated Serving Bowls



Setting the Standard®

- Mirror finish exterior for an upscale look
- Double wall construction provides insulation to maintain proper food temperature - hot or cold.
- Will not sweat.
- Requires no preheating or chilling.
- Heavy Gauge stainless steel will not affect taste or color of food.
- Satin finish interior hides scratches and wear.

Does Double Wall Insulation work? See for yourself!

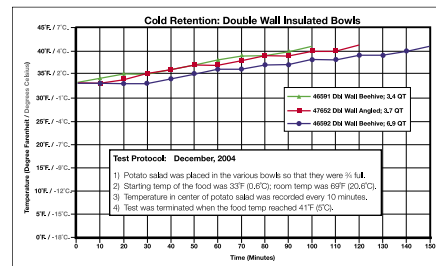
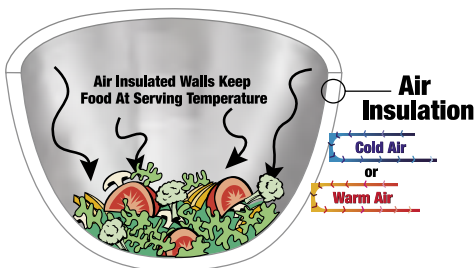

Double Wall Insulated Serving Angled Bowls 斜角圆形碗

CODE	SIZE (l x w x h cm)	CAPACITY Ltr
4040109	18.8 x 13.9	0.95
4040118	24.0 x 17.3	1.8
4040135	30.0 x 15.0	3.5
4040147	35.0 x 23.8	4.7



Round Beehive Double Wall Insulated Bowls 圆形环纹碗

CODE	SIZE (l x w x h cm)	CAPACITY Ltr
4040307-xx	14.4 x 7.6	0.7
4040316-xx	18.4 x 10.3	1.6
4040332-xx	24.1 x 12.9	3.2
4040366-xx	30.0 x 16.5	6.6

*Available Colour

RD WH BK YL

When ordering red bowl add **CODE** suffix to item number (example: 4040307-03)



Square Beehive Double Wall Insulated Bowls 方形环纹碗

CODE	SIZE (l x w x h cm)	CAPACITY Ltr
4040407-xx	13.9 x 13.9 x 7.0	0.7
4040417-xx	18.4 x 18.4 x 8.7	1.7
4040430-xx	21.6 x 21.6 x 10.8	3.0
4040449-xx	25.8 x 25.8 x 13.0	4.9

*Available Colour

RD WH BK YL

When ordering red bowl add **CODE** suffix to item number (example: 4040407-03)

Camtread® Fibre Glass Service Tray with Non-Slip Surface 玻璃钢防滑托盘

An industry standard for caterers, hotels, banquet halls, dining rooms and bars. Non-skid surface ensures drinks and meals stay in place, during transport. Made of heavy-duty, durable fiberglass with a thick molded in, non-skid surface.

COLOURS AVAILABLE:

BLACK - 110, Tarven Tan - 138

CAMBRO

CODE	SIZE	CODE	SIZE	CODE	SIZE
	inch		inch		inch
Round		Rectangle		Oval	
4052011-xx	11	4052110-xx	10 x 14	4052225-xx	19.25 x 23.18
4052014-xx	14	4052112-xx	12 x 16	4052227-xx	22.00 x 26.78
4052016-xx	16	4052114-xx	14 x 18	4052229-xx	28.78 x 23.50
		4052115-xx	15 x 20		
		4052116-xx	16 x 22		
		4052118-xx	18 x 26		



Treadlite Fibreglass Service Tray with Non-Slip Surface 玻璃钢防滑托盘

COLOURS AVAILABLE: BLACK - 110, Tarven Tan - 138

CAMBRO

CODE	SIZE	CODE	SIZE
	inch		inch
Round		Rectangle	
4052314-xx	14	4052414-xx	14 x 18
4052316-xx	16	4052415-xx	15 x 20
		4052416-xx	16 x 22



Polytread® Service Tray W / Non-Slip Surface 聚酯防滑托盘

COLOURS AVAILABLE: BLACK - 110, BROWN - 167

CAMBRO

CODE	SIZE	CODE	SIZE
	inch		inch
Round		Rectangle	
4052511-xx	11	4052610-xx	10 x 14
4052514-xx	14	4052612-xx	12 x 16
4052516-xx	16	4052614-xx	14 x 18

An economical service tray for restaurants, bars and banquet service. General, all-purpose, non-skid service trays help reduce spills and breakage. Special non-skid surface is bonded directly into a lightweight polypropylene tray. Dri-Stak separators allow air to circulate freely over and under each tray for fast drying.



• Lightweight, weighs up to 30% less than wood room service trays. Dishwasher safe once a day, easily wipes clean. Saves time and labour. Standard 14" x 19" tray mat can be used on the surface of the tray.

Capri Laminated Room Service Tray 卡普里 - 带光滑表面的压面托盘

VENGE COLOUR FINISH

CODE	SIZE	Internal Size
	inch	
4052712	15.5 x 25	14 x 21

Stainless Steel Service Tray with Anti-Slip Mat 钢防滑托盘

ATHENA®

CODE	SIZE
	cm
4053100	32 x 2.7
4053101	38 x 2.7



FOOD SERVICE & BUFFET WARE



Aluminium Service Tray Stand 托盘架

CODE	SIZE
	when in operation
4053001	46 x 44 x 80 cm

Wooden Service Tray Stand 托盘木架

CODE	SIZE
	when in operation
4053000	48.0 x 42.5 x 81.4 cm

Chrome Service Tray Stand 托盘架

CODE	SIZE	
	when in operation	
4052900	45 x 48 x 73 cm	Chrome Finish

Wooden Service Tray Stand 托盘木架

CODE	SIZE	
	when in operation	
4052800	50 x 46 x 79.5 cm	Brown Finish
4052801	50 x 46 x 79.5 cm	Black Finish

Melamine Buffet Display 美耐皿自助餐展示

- Melamine is synthetic resin, it becomes harden and formed after heating, heat and corrosion resistant, widely used for dishware, and is a popular plastic material.
- Non-toxic, non-odourous, light weight, break resistant, free form deformation, low-conductivity
- All our products passed SGS food safety certification, please feel assured to use and control the temperature between -20 ~ +120°C



Code	Description	Dimension (l x w x h mm)	Remark
4170100	Bamboo Multi Functional 2/8 Holder 2S	325 x 132 x 19	MEBO-6002
4170101	4Pcs Serving Dish W/Bamboo Tray Set	130 x 115 x 300	MEBO-600801
4170102	4Pcs Serving Dish W/Bamboo Tray Set	150 x 85 x 300	MEBO-601001

Gourmet Board



Code	Description	Dimension (l x w x h mm)	Remark
4170211	Round Mela 11"	270 x 180 x 15	MEDT-406111
4170217	Round Mela 17"	300 x 450 x 15	MEDT-406117
4170221	Round Mela 21"	530 x 380 x 15	MEDT-406121
4170321	Rectangular 21"	530 x 200 x 15	MEDT-406221
4170324	Rectangular 24"	610 x 200 x 15	MEDT-406224

Woody Board



Code	Description	Dimension (l x w x h mm)	Remark
4170411	GN 1/1	530 x 325 x 10	MEGN-1110W
4170412	GN 1/2	325 x 265 x 10	MEGN-1210W
4170413	GN 1/3	325 x 176 x 10	MEGN-1310W
4170414	GN 1/4	265 x 162 x 10	MEGN-1410W
4170424	GN 2/4	530 x 162 x 10	MEGN-2410W
4170525	25 X 15CM	250 x 150 x 10	METW-2515
4170550	50 X 25CM	500 x 250 x 10	METW-5025

Taroko Granite Slate



Code	Description	Dimension (l x w x h mm)	Remark
4170611	GN 1/1	530 x 325 x 7	METS-5332BK
4170612	GN 1/2	325 x 265 x 7	METS-3226BK
4170613	GN 1/3	325 x 176 x 7	METS-3217BK
4170624	GN 1/4	530 x 162 x 7	METS-5316BK

Marble Board



Code	Description	Dimension (l x w x h mm)	Remark
4170718	Triangular	465 x 366 x 20	MEDP-101118
4170724	Oblong	590 x 240 x 24	MEDP-101124

Geometry



Code	Description	Dimension (l x w x h mm)	Remark
4170808	8" Cone	130 x 130 x 150	MEDA-515508
4170908	8" Cone Stand	160 x 160 x 120	WIDS-9001
4170810	10" Cone	140 x 140 x 200	MEDA-515510
4170910	10" Cone Stand	190 x 190 x 130	WIDS-9002

FOOD SERVICE & BUFFET WARE

3D Non Slip Display Stand



4171004



4171006

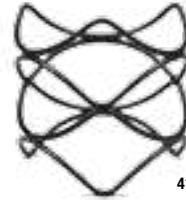

4171008

Code	Description	Dimension (l x w x h mm)	Remark
4171004	Dance 4"H	215 x 215 x 100	WIDS-R0604
4171006	Dance 6"H	215 x 215 x 150	WIDS-R0606
4171008	Dance 8"H	215 x 215 x 200	WIDS-R0608

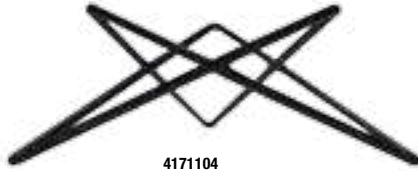

4171104

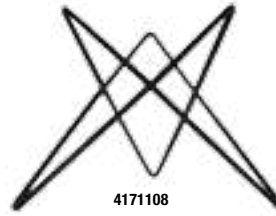

4171108

Code	Description	Dimension (l x w x h mm)	Remark
4171104	Star 4"H	300 x 300 x 100	WIDS-R0704
4171108	Star 6"H	300 x 300 x 200	WIDS-R0708

MEHNDI Bowl



4171231



4171331

Code	Description	Dimension (l x w x h mm)	Remark
4171231	Oval Bowl	800 x 595 x 177	MEDB-206131
4171331	Round Bowl	800 x 800 x 207	MEDB-206231



4171410



4171514



4171621

Code	Description	Dimension (l x w x h mm)	Remark
4171410	10" Bowl	250 x 120 x 75	MEDB-224310
4171514	SQ Bowl	355 x 355 x 123	MEDB-224414
4171621	21" Bowl	530 x 270 x 107	MEDB-224521

Petit



Code	Description	Dimension (l x w x h mm)	Remark
4171801	Galaxy 4" Dish	100 x 78 x 34	MEDA-516504
4171802	Galaxy 3" Dish	80 x 80 x 33	MEDA-516603
4171803	Royal Ascot 4	101 x 78 x 46	MEDA-516304
4171804	Drop 4" Bowl	100 x 75 x 48	MEDA-516404
4171805	Royal Ascot 5	119 x 88 x 34	MEDA-516205
4171806	Drop 4" Dish	100 x 70 x 24	MEDA-515904
4171807	Venus 4" Dish	89 x 68 x 20	MEDA-516104
4171808	Boat 4" Dish	91 x 63 x 32	MEDA-517504
4171809	CA 4" Holder	100 x 70 x 48	MEDA-517904

GN Pan

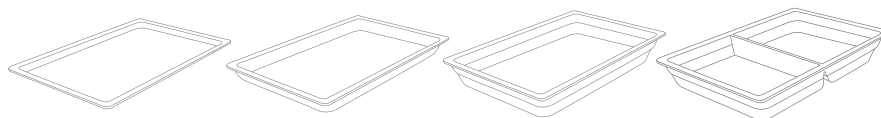

Code	Description	Dimension (l x w x h mm)	Remark
4171901	GN 1/1 20mm America	530 x 325 x 20	MEDP-1120A
4171902	GN 1/1 40mm America	530 x 325 x 40	MEDP-1140A
4171903	GN 1/1 65mm America	530 x 325 x 65	MEDP-1165A
4171904	GN 1/1 65mm America 2 compartments	530 x 325 x 65	MEDP-1165AC

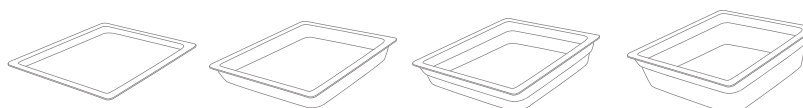

Code	Description	Dimension (l x w x h mm)	Remark
4172001	GN 1/2 20mm America	325 x 265 x 20	MEDP-1220A
4172002	GN 1/2 40mm America	325 x 265 x 40	MEDP-1240A
4172003	GN 1/2 65mm America	325 x 265 x 65	MEDP-1265A
4172004	GN 1/2 100mm America	325 x 265 x 100	MEDP-12100A

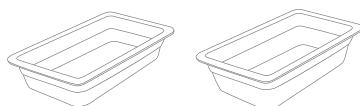

Code	Description	Dimension (l x w x h mm)	Remark
4172101	GN 1/3 65mm America	325 x 175 x 65	MEDP-1365A
4172102	GN 1/3 100mm America	325 x 175 x 100	MEDP-13100A

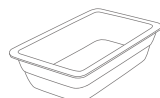

Code	Description	Dimension (l x w x h mm)	Remark
4172201	GN 1/4 65mm America	265 x 160 x 65	MEDP-1465A

FOOD SERVICE & BUFFET WARE

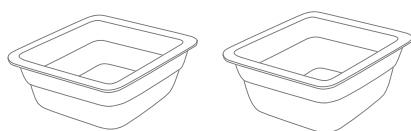

Code	Description	Dimension (l x w x h mm)	Remark
4172301	GN 1/6 65mm America	175 x 160 x 65	MEDP-1665A
4172302	GN 1/6 100mm America	175 x 160 x 100	MEDP-16100A

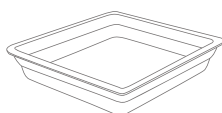

Code	Description	Dimension (l x w x h mm)	Remark
4172401	GN 2/3 65mm America	350 x 325 x 65	MEDP-2365A

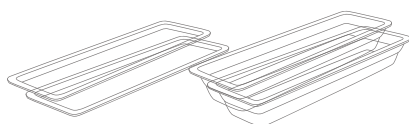

Code	Description	Dimension (l x w x h mm)	Remark
4172501	GN 2/4 20mm America	525 x 160 x 20	MEDP-2420A
4172502	GN 2/4 65mm America	525 x 160 x 65	MEDP-2465A



Rectangular Ribbed Bowls 长方形棱纹碗

CAMBRO

CODE	SIZE (l x w x h cm)	CAPACITY	
		Ltr	Qt
4070212-xx	22.9 x 30.8	2.7	2.9
4070214-xx	27.3 x 37.0	4.7	4.0
4070219-xx	36.2 x 49.2	11.3	12.0

*Available Colour

CL BK

When ordering Black add **CODE** suffix to item number
(example: 4070212-03)



Round Ribbed Bowls 圆形棱纹碗

CAMBRO

CODE	SIZE (Ø cm)	CAPACITY	
		Ltr	Qt
4070306-xx	15.2	0.56	0.6
4070308-xx	20.3	1.6	1.65
4070310-xx	25.4	3.0	3.2
4070312-xx	30.5	5.5	5.8
4070315-xx	38.1	10.6	11.2
4070318-xx	45.7	19.1	20.2
4070323-xx	58.1	37.8	40

*Available Color

WH BK CL

When ordering White add **CODE** suffix to item number
(example: 4070306-02)



Bell-Shaped Pebbled Bowls 铃形橘纹碗

CAMBRO

CODE	SIZE (l x w x h cm)	CAPACITY	
		(inch)	QT
4070410	25.00	9.87	2.1
4070412	30.48	12	4.0
4070418	45.70	18	12.5



Round Pebbled Bowls 圆橘纹碗

CAMBRO

CODE	SIZE (Ø cm)	CAPACITY	
		Ltr	Qt
4070106	15.2	0.55	0.6
4070108	20.3	1.7	1.8
4070110	25.4	3.0	3.2
4070112	30.5	5.5	5.8
4070115	38.1	10.6	11.2
4070118	45.7	19.1	20.2
4070123	58.4	37.8	40



Fiberglass Bowls 玻璃纤维碗

CAMBRO

CODE	SIZE (l x w x h cm)	CAPACITY	
		(inch)	oz
4070506	15.5	6.125	14.3
4070508	20.3	8	31.2



Acrylic Display Tray / Bowls / Plate / Riser



Round

CODE	SIZE (Ø x h cm)
4060101	11 x 2.5



Square

CODE	SIZE (l x w x h cm)
4060203	11 x 11 x 3



Leaf Shape

CODE	SIZE (l x w x h cm)
4060305	15 x 2
4060306	18 x 3
4060307	24 x 3



Rectangular

CODE	SIZE (l x w x h cm)
4060426	16.5 x 11.5 x 2



Round

CODE	SIZE (Ø x h cm)
4060527	12 x 4.2
4060627	10.5 x 4



Square Slant Deep Salad / Punch Bowl

CODE	SIZE (l x w x h cm)
4060703	30 x 30 x 12.0
4060704	36 x 36 x 12.5



Rectangular

CODE	SIZE (l x w x h cm)
4060810	31.0 x 21.0 x 2
4060811	26.0 x 15.0 x 2
4060812	35.0 x 25.5 x 2
4060813	41.5 x 31.5 x 2



Rectangular Wavy Deep Sea Bowl

CODE	SIZE (l x w x h cm)
4061260	33.5 x 26.5 x 12.5



Fan Shape Sushi plate

CODE	SIZE (l x w x h cm)
4061701	32.0 x 19 x 3
4061702	27.5 x 17 x 3
4061703	23.5 x 15 x 3



Rectangular Sushi Plate

CODE	SIZE (l x w x h cm)
4061801	24.5 x 17.5 x 3
4061802	21.0 x 15.5 x 3
4061803	17.0 x 13.5 x 3

Acrylic Display Tray / Bowls / Plate / Riser

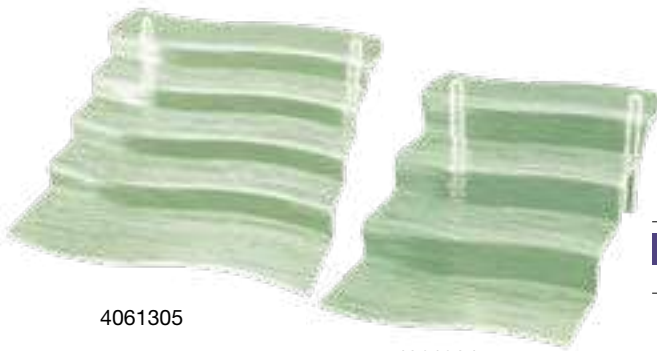

Staircase Display Plate

CODE	SIZE (l x w x h cm)	
4061305	48 x 41.5 x 16	5 Steps
4061304	38.5 x 31 x 16	4 Steps



Rectangular Riser Display

CODE	SIZE (l x w x h cm)
4061006	40 x 30 x 6
4061011	40 x 30 x 11
4061016	40 x 30 x 16



Narrow Rectangular Riser Display

CODE	SIZE (l x w x h cm)
4060906	50 x 15 x 6
4060911	50 x 15 x 11
4060916	50 x 15 x 16



Rectangular Plate

CODE	SIZE (l x w x h cm)
4061590	25.5 x 20.0 x 2
4061591	31.0 x 22.5 x 2
4061592	39.0 x 28.0 x 3



Square Pointed Salad Bowl

CODE	SIZE (l x w x h cm)
4060826	24.5 x 24.5 x 7.5
4060827	28.5 x 28.5 x 9
4060828	33.5 x 33.5 x 11



Square Curve Salad Bowl

CODE	SIZE (l x w x h cm)
4061101	27.5 x 27.5 x 13
4061102	36.0 x 36.0 x 16



Square Small Dish

CODE	SIZE (l x w x h cm)
4061478	13.5 x 13.5 x 1.5
4061489	14.5 x 14.5 x 2.0



Rectangular Sushi Plate

CODE	SIZE (l x w x h cm)
4061601	36.5 x 13 x 3
4061602	29.5 x 13 x 3
4061603	22.0 x 13 x 3



Rectangular Sashimi Plate with Drainer

CODE	SIZE (l x w x h cm)
4061901	23.5 x 19 x 4
4061902	29 x 23 x 4.5
4061903	35.5 x 28 x 6

Polycarbonate Serving Wares



Camwear Ladles 长勺

CODE	SIZE		CAPACITY
	(l x w x h cm)	(inch)	
4080125-xx	21.6	8.5	25
4080130-xx	26.8	10.5	30

***Available Colour**

■ BK ■ BG □ WH ■ BR

When ordering Black add **CODE** suffix to item number
(example: 4080125-BK)



Perforated Deli Spoon 有孔熟食匙

CODE	SIZE	
	(l x w x h cm)	(inch)
4080211-xx	27.9	11
4080313-xx	33.0	13

***Available Colour**

■ BK □ WH ■ RD

When ordering Black add **CODE** suffix to item number
(example: 4080211-BK)



Buffet Spoon 自助餐匙

CODE	SIZE	
	(l x w x h cm)	(inch)
4080410-xx	25	10

***Available Colour**

■ BK □ WH ■ RD

When ordering Black add **CODE** suffix to item number
(example: 4080410-BK)



Deli Spoon 熟食匙

CODE	SIZE	
	(l x w x h cm)	(inch)
4080511-xx	27.9	11
4080613-xx	33.0	13

***Available Colour**

■ BK □ WH ■ RD

When ordering Black add **CODE** suffix to item number
(example: 4080511-BK)



High Heat Deli Spoon 耐高温熟食匙

CODE	SIZE	
	(l x w x h cm)	(inch)
4080713	33.0	13

Polycarbonate Serving Wares

Perforated High Heat Deli Spoon

耐高温有孔匙

CODE	SIZE	
	(l x w x h cm)	(inch)
4080913	33.0	13

High Heat Turner

耐高温无孔平锅铲

CODE	SIZE		
	(l x w x h cm)	(inch)	
4080814	35.5	14	Solid
4081014	35.5	14	Slotted



Flat Grip Tong

聚碳酸酯平头夹子

CODE	SIZE	
	(l x w x h cm)	(inch)
2230206-xx	15.0	6
2230209-xx	22.8	9

*Available Colour

BK
 CL
 RD
 WH
 BG

When ordering Black add **CODE** suffix to item number
(example: 2230206-BK)



Scallop / Comb Angled Tong

扇贝形/带斜角夹子

CODE	SIZE		
	(l x w x h cm)	(inch)	
2230326	26.0	10.25	Comb
2230321	21.0	8.25	Comb
2230106-xx	15.0	6	Scallop
2230109-xx	22.8	9	Scallop
2230112-xx	30.5	12	Scallop

*Available Colour

BK
 CL
 RD
 WH
 BG

When ordering Black add **CODE** suffix to item number
(example: 2230106-BK)



PIAZZA's tongs have always been the collection used as reference point for the market, both for design and for the effective superiority of a product that is a must for every professional's collection.

Lastly, the details highlight the uniqueness of each individual pair: the curvature of certain applications, such as the spaghetti tongs, which is like an invitation to gather up the food in the best way; or the spring which always gives the same manoeuvrability even after an infinite number of pressing, this thanks to an exclusive production device which is still secret today, as are the formulas which for years have resisted all attempts of imitation. Precisely this certainty permits Piazza alone to guarantee the inalterability of its tongs.



Pastry Scissor Tong
不锈钢蛋糕夹

CODE	SIZE (l cm)
2220118	18.5



Pastry Scissor Tong
不锈钢蛋糕夹

CODE	SIZE (l cm)
2220220	20



Universal Scallop Tong
不锈钢扇贝形万能夹

CODE	SIZE (l cm)
2222118	18.0
2222112	12.0
2222123	23.5
2222130	30.0



Flat Curved Universal Tong
不锈钢万能夹

CODE	SIZE (l cm)
2222218	18
2222223	23
2222230	30



Fork & Spoon Serving Tong
不锈钢服务夹

CODE	SIZE (l cm)
2220323	23



Flat Front Serving Tong
不锈钢面包夹

CODE	SIZE (l cm)
2220423	23



Bright Serving Tong
不锈钢服务夹

CODE	SIZE (l cm)
2221119	19.5



Spaghetti Tong
不锈钢面夹

CODE	SIZE (l cm)
2220630	30



Spaghetti Tong
面夹

CODE	SIZE (l cm)
2220523	23.5



Vegetable Tong
蔬菜夹

CODE	SIZE (l cm)
2221019	19.5



Salad Tong
沙拉夹

CODE	SIZE (l cm)
2221719	19.5



“MOLLUNGA” Buffet Tong
自助餐夹

CODE	SIZE (l cm)
2220730	30



Bread Tong
面包夹 (有洞)

CODE	SIZE (l cm)
2220916	16.5



Toast Tong
不锈钢面包夹 (有洞)

CODE	SIZE (l cm)
2221221	21



Buffet Toast Tong
自助餐点心夹

CODE	SIZE (l cm)
2220830	30



Pastry Tong
蛋糕夹

CODE	SIZE (l cm)
2221518	18



Sugar Tong
糖果夹

CODE	SIZE (l cm)
2221412	12.5



Ice Cube Tong
冰块夹

CODE	SIZE (l cm)
2221616	16



Molla Ice Cube Tong
冰块夹

CODE	SIZE (l cm)
2221318	18



4091101

GRAVY LADLE
805-GL/ 168MM



4091201

CAKE SERVER
805-KS/ 240MM



4091401

SERVING FORK
805-VF/ 232MM



4091301

SERVING SPOON
805-VS/ 232MM



4091501

SALAD FORK
805-AF/ 232MM



4091502

SALAD SPOON
805-AS/ 232MM



4091901

COCKTAIL/ SOUP LADLE
805-SL/ 293MM



4091601

BUFFET SPOON
BU-17/ 260MM



4091603

BUFFET SPOON,
SLOTTED
BU-17S/ 260MM



4091602

BUFFET SPOON, L
BU-17L/ 305MM



4091604

BUFFET SPOON, L
SLOTTED
BU-17LS/ 305MM

1



4092401

2



4092402

- ① BUFFET TONGS REST
BU-47/ 150×72×29(H)MM
- ② SERVING SPOON REST
BU-23/ 265×130×48(H)MM



4091801

PASTRY TONGS
BU-18/ 200MM



4092501

PICKLE TONGS
BU-19/ 100MM



2221920

SCISSOR PASTRY TONGS
BU-20/ 212MM



2222021

SCISSOR SALAD TONGS
BU-21/ 212MM



4091702

SPAGHETTI TONGS
BU-15/ 256MM



4091701

SERVICE TONGS
BU-14/ 240MM



4092001

GRAVY LADLE,
OVAL BOWL
805-GLC/ 185MM



4092101

DRESSING LADLE,
OVAL BOWL
805-DL/ 270MM



4092201

COCKTAIL/
SOUP LADLE, L
805-SLL/ 330MM



4092301

COCKTAIL
LADLE, CLASSIC
805-CLC/ 415MM



4092403

BUFFET LADLE REST
BU-46/Ø110×103(H)MM

Stainless Steel Sauce Boat 钢汁船

CODE	CAPACITY (oz)
4100102	2
4100103	3
4100108	8



Stainless Steel Water Pitcher 不锈钢水壶

ATHENA[®]

CODE	CAP Ltr	SERIES
4101200	1.5	Renaissance
4101201	1.5	Fusion
4101202	1.5	Horizon

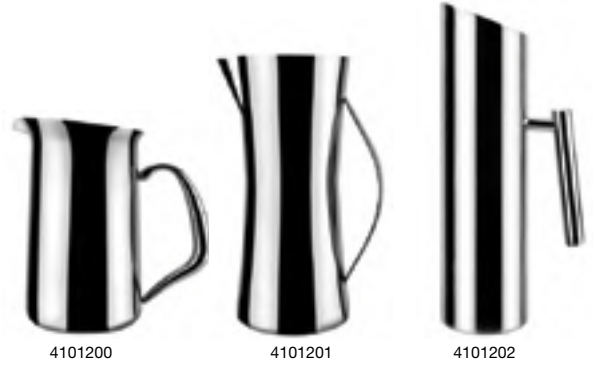

Insulated Mirror Polish Stainless Steel Beverage Server 不锈钢保温壶

ATHENA[®]

CODE	CAP Ltr
4101303	0.35
4101306	0.65
4101310	1.0
4101315	1.5



Stainless Steel Insulated Flask with Rubber Stopper 不锈钢保温壶

CODE	CAP Ltr	REMARKS
4101110	1.0	Red Body
4101210	1.0	Stainless Steel Matt
4101215	1.5	Stainless Steel Matt



Stainless Steel Insulated Drink Server with Handle + Spout 不锈钢保温壶

CODE	CAP Ltr
4100603	0.3
4100606	0.6
4100610	1.0
4100615	1.5
4100620	2.0

Table Top Food Bar 桌面食品吧

- Choose from table top food bars or buffet food bars.
- Available in a variety of styles and lengths, with optional accessories to further enhance service opportunities.
- Table Top Food Bars turn a 4' - 6' (130 - 182 cm) table into a double-sided self service buffet or beverage station.
- Buffet Bar Bases are ideal for holding snacks and cold beverages.
- The Buffet Bar with Sneeze Guard is perfect for single-side, self serve buffets.
- Durable, lightweight polyethylene will never dent, rust, break, bubble or chip.
- Easy to clean.
- This fully portable system keeps food cold for hours with the Buffet Camchillers®



	4FBRTT	5FBRTT	6FBRTT
PRODUCT CODE	4120204-XX	4120205-XX	4120206-XX
MANUFACTURE CODE	4FBRTT	5FBRTT	6FBRTT
HOLDING CAPACITY	3 x GN 1/1 Pan	4 x GN 1/1 Pan	5 x GN 1/1 Pan
OVERALL DIA (l x w x h cm)	129.5 x 84.5 x 68.6	161.3 x 84.5 x 68.6	181.6 x 84.5 x 68.6
INTERNAL DIA (l x w x h cm)	94.6 x 51.1 x 16.5	127.2 x 51.1 x 16.5	159.7 x 51.1 x 16.5
COLOUR AVAILABLE	Black / Hot Red	Black / Hot Red	Black / Hot Red

*Available Colour

■ BK ■ HRD (hot red)

When ordering Black Colour add **CODE** suffix to item number (example: 4120204-BK)

Economy Standard Decor Portable Cambars® 移动式吧台

- Stylish, portable beverage bars for hosting in any environment.
- Select from three systems: economy for bottle and can service, partial or complete soda gun set up systems for pre-mix (canisters) or post-mix (bag-in- box).
- Available in three sizes:
 - Large BAR730 is perfect for banquets and cocktail events.
 - Mid-size BAR650 fits into standard elevators and is ideal for small to mid-size functions.
 - Small BAR540 is ultra portable for off-premise use and events with limited space.
- All models include speed rail and 36,3 kg capacity ice sink with cover. BAR540 sink comes uncovered.
- Impact-resistant, waterproof polyethylene will not crack, dent, bubble, chip, rust or break.
- Lightweight and portable.
- Easy to take apart and clean, easy to set up.



	BAR540	BAR650	BAR730
PRODUCT CODE	4121100-XX	4121101-XX	4121102-XX
MANUFACTURE CODE	BAR540	BAR650	BAR730
OVERALL DIA (l x w x h cm)	137.2 x 65.7 x 117.2	171.5 x 72.4 x 120.7	184.8 x 66 x 121.9

Standard Equipment Delivered With Economy Cambar® Series

BAR540 (4121100)

- 1 speed rail (5 bottles), one 36.3kg capacity ice sink, four 12.7(5") swivel Casters, 2 with brake & 1 vinyl cover.

BAR650 (4121101)

- 1 speed rail (7 bottles), one 36.3kg capacity ice sink, 1 ice sink cover, 1 waste-water bin, 1 retainer strap, four 15.24(6") swivel Casters, 2 with brake & 1 vinyl cover.

BAR730 (4121102)

- 1 speed rail (7 bottles), one 36.3kg capacity ice sink, 1 ice sink cover, 1 waste-water bin, 2 retainer strap, four 15.24(6") swivel Casters, 2 with brake & 1 vinyl cover.

*Available Colour

■ BK ■ GNGY (granite grey)

When ordering BLACK Colour add **CODE** suffix to item number (example: 4121100-BK)

Portable Cambars® are available in other Designer Decor as well as a Complete solutions with optional accessories. Please kindly contact us for more information.

Insulated Beverage Dispenser

- Use to hold, transport and serve hot or cold beverages.
- One piece, seamless double-wall polyethylene with thick foam insulation.
- Sturdy latches secure lids tightly and will never rust.
- Drip-proof recessed spigot for easy self-serve access.
- Stack units on riser to fill large cups or coffee pots.
- Sta-stack interlocking ensures stable stacking during transport and storage.



250LCD



500LCD



1000LCD

PRODUCT CODE	4121702-XX	4121705-XX	4121710-XX
CAMBRO CODE	250LCD	500LCD	1000LCD
CAPACITY	9.5 Ltrs (2.5 Gal)	17.9 Ltrs (4.75 Gal)	44.5 Ltrs (11.75 Gal)
NO OF CUP (210ml)	45	85	214
OVERALL DIA (w x d x h cm)	23x 42 x 47	23 x 42 x 62	41.5 x 53 x 63
CAMTAINER COVERS	250LCDCVR	500LCDCVR	1000LCDCVR

***Available Colour**

■ BK ■ BR ■ BG ■ SLBL ■ BRR ■ GR

When ordering Brown add **CODE** suffix to item number (example: 4121702-BR)

Ultra Beverage Camtainer



UC250



UC500



UC1000

PRODUCT CODE	4121602-XX	4121605-XX	4121610-XX
CAMBRO CODE	UC250	UC500	UC1000
CAPACITY	10.4 Ltrs (2.75 Gal)	19.9 Ltrs (5.25 Gal)	39.7 Ltrs (10.5 Gal)
NO OF CUP (210ml)	50	96	192
OVERALL DIA (w x d x h cm)	30 x 42.5 x 50	30 x 42.5 x 68	41.5 x 52 x 65.5
CAMTAINER COVERS	UC250CVR	UC500CVR	UC1000CVR

***Available Colour**

■ BR ■ SLBL

When ordering Brown add **CODE** suffix to item number (example: 4121602-BR)

Optional Accessories for Beverage Camtainer

Riser & Condiment Holder



	R500LCD	R1000LCD	LCDCH	LCDCH10
PRODUCT CODE	4121900-XX	4121901-XX	4121902-XX	4121903-XX
CAMBRO CODE	R500LCD	R1000LCD	LCDCH	LCDCH10
DESCRIPTION	Riser	Riser	Condiment Holder	Condiment Holder
OVERALL DIA (w x d x h cm)	23 x 41.5 x 12	39 x 49.5 x 11.5	22 x 42 x 13	41 x 51 x 12
FITS	250LCD, 500LCD UC250, UC500	1000LCD, UC1000	250LCD, 500LCD, UC250, UC500	1000LCD, UC1000

***Available Colour**

BR BG When ordering Brown add **CODE** suffix to item number (example: 4121900-BR)

Handwash Accessories - for Camtainer & Ultra Camtainer

Cover Accessories - for Camtainer Only



	HWAPR	250LCDVR	500LCDVR	1000LCDVR
PRODUCT CODE	4121904	4122001	41222002	4122003
CAMBRO CODE	HWAPR	250LCDVR	500LCDVR	1000LCDVR
DESCRIPTION	Soap & Towel Hand Roll Dispenser	For 250LCD Camtainer	For 500LCD Camtainer	For 1000LCD Camtainer
FITS				

Beverage Camserver

- A front-of-house beverage server for hot or cold beverages that does not require canned heating.
- Double-wall polyethylene shell with thick foam insulation retains temperatures for hours.

***Available Colour**

BK (black) GNGY (granite grey)

When ordering Beige add **CODE** suffix to item number (example: 4121503-BG)



	CSR3	CSR5
PRODUCT CODE	4121503-XX	4121505-XX
CAMBRO CODE	CSR3	CSR5
CAPACITY	11.5 Ltrs (2.5 Gal)	19 Ltrs (5 Gal)
NO OF CUP (210ml)	54	91
OVERALL DIA (w x d x h cm)	34 x 46.5 x 60	34 x 46.5 x 71

FOOD SERVICE & BUFFET WARE

Insulated Beverage Dispenser

- Complete with Stainless Steel Insert for better Hygiene & easy maintenance



0756

PRODUCT CODE 4125110-XX

CAPACITY 10 L / 2.6 Gal

OVERALL DIA (l x w x h cm) 29 x 26 x 34

Available Colour
■ RD ■ BR
■ BL ■ GN



0332

PRODUCT CODE 4125117-XX

CAPACITY 17 L / 4.5 Gal

OVERALL DIA (l x w x h cm) 32 x 30 x 46

Available Colour
■ RD ■ BR
■ BL ■ GN



9903

PRODUCT CODE 4125213-XX

CAPACITY 13 L / 3 Gal

OVERALL DIA (l x w x h cm) 32 x 30 x 33

Available Colour
■ RD ■ BR
■ BL ■ GN



9905

PRODUCT CODE 4125215-XX

CAPACITY 15 L / 4 Gal

OVERALL DIA (l x w x h cm) 32 x 30 x 42.5

Available Colour
■ RD ■ BR
■ BL ■ GN



9907

PRODUCT CODE 4125217-XX

CAPACITY 18.8 L / 5 Gal

OVERALL DIA (l x w x h cm) 32 x 30 x 49.56

Available Colour
■ RD ■ BR
■ BL ■ GN



0533

PRODUCT CODE 4125313-XX

CAPACITY 13 L / 3 Gal

OVERALL DIA (l x w x h cm) 32 x 30 x 33

Available Colour
■ RD ■ BR
■ BL ■ GN



0535

PRODUCT CODE 4125317-XX

CAPACITY 17 L / 5 Gal

OVERALL DIA (l x w x h cm) 34 x 34 x 46

Available Colour
■ RD ■ BR
■ BL ■ GN



0753

PRODUCT CODE 4125410-XX

CAPACITY 10 L / 2.6 Gal

OVERALL DIA (l x w x h cm) 27 x 25 x 35.5

Available Colour
■ BK ■ BR



0754

PRODUCT CODE 4125412-XX

CAPACITY 12 L / 3.15 Gal

OVERALL DIA (l x w x h cm) 27 x 25 x 42

Available Colour
■ BK ■ BR

**Stainless Steel Condiment 'BALL'
Bowl with Wooden Base**
不锈钢球形罐配木底架

CODE	SIZE (l x w x h cm)	Bowl Size
4033045	53 x 15 x 6	Ø 15
4033046	54 x 15 x 6	Ø 20
4033047	55 x 15 x 6	Ø 25



**Stainless Steel Condiment 'BALL'
Bowl Only**
加厚不锈钢球形罐

CODE	SIZE (Ø cm)
4033115	15
4033120	20
4033125	25



**3 Tier Condiment Stand with
Polycarbonate Holder**
三层单列PC食物挂架

CODE	SIZE (l x w x h cm)
4033221	22 x 17.5 x 44.5



**4 Tier Condiment Stand with
Polycarbonate Holder**
四层单列PC食物挂架

CODE	SIZE (l x w x h cm)
4033223	22 x 23 x 59



**2 x 3 Tier Condiment Stand with
Polycarbonate Holder**
三层双列PC食物挂架

CODE	SIZE (l x w x h cm)
4033222	44 x 17.5 x 44.5



**2 x 4 Tier Condiment Stand with
Polycarbonate Holder**
四层双列PC食物挂架

CODE	SIZE (l x w x h cm)
4033224	22 x 23 x 59



Polycarbonate Holder
PC 食物料斗

CODE	SIZE (l x w x h cm)
4033308	20.3





Versa Organizers

多功能组合架

CAMBRO

Use to store non-perishable condiments, disposable ware and napkins.

- Hold bins in 2 x 3, 2 x 4, 3 x 3, or 3 x 4 arrangements.
- Made of seamless, one-piece polyethylene.
- Set on flat surface or wall mount each bin holds up to 10 lbs. (4.5 kg).
- Easy to assemble and easy to clean.

CODE	SIZE (w x d x h cm)	REMARK
4123706-xx	51.1 x 48.8 x 24.1	6-Bins, 3 Bins x 2 Rows
4123708-xx	64.8 x 48.8 x 24.1	8-Bins, 4 Bins x 2 Rows
4123709-xx	51.1 x 54.3 x 36.2	9-Bins, 3 Bins x 3 Rows
4123712-xx	64.8 x 54.3 x 36.2	12-Bins, 4 Bins x 3 Rows

Spare Condiment Bin

盒子

CODE	SIZE (w x d x h cm)
4123800-xx	13 x 30.5 x 11

*Available Colour

■ BK ■ BR ■ SPGY (speckled grey)

When ordering Black colour, add **CODE** suffix to item number (example: 4123706-BK)



Self-Serve System

多功能组合架

TRAEX®

- Versatile self-serve bins can be used alone, stacked, or mounted
- Made of durable plastic
- Stands can be secured together with aluminum clips
- Ideal for flatware, tea, condiment packets, salt & pepper, or products with high volume usage

8" Bins 2 & 3 Tier Set

CODE	SIZE (w x d x h cm)	REMARK
4123901-xx	14.3 x 32 x 23.0	2-Tier
4123902-xx	14.3 x 32 x 35.3	3-Tier

11" Bins 2 & 3 Tier Set

CODE	SIZE (w x d x h cm)	REMARK
4123903-xx	14.3 x 50.2 x 23.0	2-Tier
4123904-xx	14.3 x 50.2 x 35.3	3-Tier

Spare Condiment Bins

CODE	SIZE (w x d x h cm)	REMARK
4123905-xx	12.6 x 20.4 x 10.8	8" Length
4123906-xx	12.6 x 28.5 x 10.8	11" Length

*Available Colour

■ BK ■ BR

When ordering Black colour, add **CODE** suffix to item number (example: 4123905-BK)

Boss Straw Bulk Dispenser, Walnut Colour (500 Straws)

吸管盒

TRAEX®

CODE	SIZE (w x d x h cm)	REMARK
4124001	10 x 23 x 17.8	1-Sided Dispensing
4124002	19 x 23 x 17.8	2-Sided Dispensing



Economy Stainless Steel Straw Dispenser

钢单面吸管盒

GOURMET
STEEL

CODE	SIZE (w x d x h cm)	REMARK
4124003	12 x 24 x 18	1-Sided Opening



Napkin Dispenser, Counter Top 2 Sided, Black 餐巾纸盒

CODE	SIZE (w x d x h cm)	REMARK
4124100	10 x 11.0 x 18.8	Hold 150 Folded Napkins 3.5" x 6.75"
4124101	20 x 15.5 x 15.0	Hold 90 Folded Napkins 5" x 6.5" or 5.25" x 6.5"



Napkin Dispenser, Counter Top 1-Sided, Black 餐巾纸盒

CODE	SIZE (w x d x h cm)	REMARK
4124102	20 x 15.5 x 15	Hold 175 Folded Napkins 5" x 6.5" or 5.25" x 6.5"



Economy Stainless Steel Napkin Dispenser, 2 Sided 餐巾纸盒

CODE	SIZE (w x d x h cm)	REMARK
4124103	9 x 12 x 14.5	Hold 150 Folded Napkins 3.5" x 5"
4124104	9 x 12 x 19.5	Hold 150 Folded Napkins 3.5" x 6.75"



Gasket Style Flex Cup Dispenser, with 4 Gasket 纸杯存放机

TRAEX®

CODE	SIZE (od x h cm)	REMARK
4124200	13.3 x 58.4	Fits 6 to 44 oz Cup INC-80



Reliable dispensing! TPR gaskets with reinforced radius and diameter ensures smooth, reliable dispensing every time with the CupPro™ Flex.

Adjustable Stainless Steel Cup Dispenser 纸杯存放机

GOURMET
STEEL

CODE	SIZE (ld x od x h cm)	REMARK
4124201	7.0 x 7.9 x 65	Fits 6 to 8 oz Cup
4124202	7.9 x 8.9 x 65	Fits 12 to 16 oz Cup
4124203	8.9 x 9.9 x 65	Fits 20 to 26 oz Cup



Sauce Dispensing Pump

酱分配器



2 & 3 S/S Pumps Non-Insulated Jar



This non-insulated rail combo features a stainless steel pumps that can dispense thin syrups and toppings without dripping. It comes in (2) or (3) stainless steel pumps solution with deep plastic fountain jars and features a brushed finish base that reduces the visibility of fingerprints.

The stainless steel pumps dispense a 1¼ oz (37 mL) serving per stroke with the option to reduce the portion size in 1/8 oz (3.7 mL) increments, using the supplied gauging collars. When you place your order, be sure to request colored knobs engraved with your contents for a clean presentation. Black knobs are standard.

82910

Code	4124301
Pumps	2
Serving	1.25 oz per portion
Capacity	3.3 L
Dimension (l x d x h)	22.4 x 27.6 x 40.8 cm
Weight	6 kg

82870

Code	4124302
Pumps	3
Serving	1.25 oz per portion
Capacity	3.3 L
Dimension (l x d x h)	22.4 x 39.4 x 40.8 cm
Weight	8.2 kg



2 & 3 Plastic Pumps Non-Insulated Jar



This non-insulated rail combo comes with (2) OR (3) Solution™ pumps and deep plastic fountain jars. The stainless steel base features a brushed finish that reduces the visibility of fingerprints.

Polycarbonate Solution™ pumps are quite versatile in their ability to dispense a variety of thick, thin and even products with particulates. Unlike most plastic pumps, Solution™ pumps offer adjustable portion control, can be disassembled, are dishwasher safe and NSF listed. A 1 ounce (30 mL) serving is the maximum portion per stroke. Portions can be reduced in ¼ ounce (7 mL) increments, using the supplied gauging collars.

79850

Code	4124401
Pumps	2
Serving	1 oz per portion (can be reduce in 0.25 oz increments)
Capacity	3.5 L
Dimension (l x d x h)	27.6 x 28.8 x 51.6 cm
Weight	5.4 kg

79860

Code	4124402
Pumps	3
Serving	1 oz per portion (can be reduce in 0.25 oz increments)
Capacity	3.5 L
Dimension (l x d x h)	39.4 x 28.8 x 51.6 cm
Weight	7.5 kg



Single Pump



This stainless steel pump with shroud dispenses directly from a #10 can or 2.8ltr stainless steel. The pump dispenses 1 ounce (30 mL) per stroke with the option to reduce portions in 1/8 ounce (3.7 mL) increments, using the supplied gauging collars. When you place your order, be sure to request a colored knob engraved with your contents for a clean presentation.

67580

Code	4124501
Pumps	1
Serving	1 oz per portion
Capacity	For Size 10 Cans / 2.8ltr Jar
Dimension (l x d x h)	36.8 x 17.8 x 29.8 cm
Weight	3.6 kg

Sauce Dispensing Pump

酱分配器

Electric Hot Fudge Server



Hot Fudge Dispenser Warmer with Pump
Operate with Water Bath

Delicious hot fudge can really enhance the appeal of ice cream sundaes or other sweet treats. This hot fudge dispenser helps you keep the topping at the proper consistency and temperature, and pump out a measured amount of hot fudge. This unit comes with the bath warmer base and pump; it is designed for use with a #10 can or a 3 quart stainless steel jar (sold separately-see "related items" below for information on how to purchase). This dispenser from Server Products is made to hold up to regular use, and dispense an amount from 1/4 ounce to one ounce amount with every pump (adjustment collars are provided).

84580

Code	4124601
Power	500 watts
Voltage	230V
Serving	30 ml per portion
Capacity	2.8 L
Dimension (l x d x h)	19.7 x 33.2 x 39.1cm



Electric Food Server



The Supreme™ style warmers dispense cheese, fudge or caramel topping in a compact footprint. They are constructed of stainless steel with a black thermoset plastic top and bottom. To eliminate burning or scorching, the water bath warmer features an adjustable thermostat that senses the temperature of the food and turns its 500 watt heating element on or off as needed. A water fill line within the well eliminates overflow accidents.

This 230V model with UK style power cord has a pump and spout warmer that dispenses opposite instrument panel side from 2.8L stainless steel jar (included). A 30ml serving is the maximum portion which can be reduced in 7ml increments, using the supplied gauging collars.

83697

Code	4124701
Power	517 watts
Voltage	230V
Serving	1 oz per portion
Capacity	2.8 L
Dimension (l x d x h)	22.7 x 39.4 x 39.2 cm



Electric Single Cone Dip Server



Server Cone Dip Warmers are constructed of stainless steel and simply designed for years of trouble-free service. A unique, tubular heating element warms your dip coat by natural convection eliminating the need for a water bath. Temperature is determined by a low to high setting ranging from ambient to 65° C. This unit is NOT a water bath warmer and should not be used as such.

The Triple Cone Dip Warmer includes a stainless steel jar for dip coat. The top with hinged lid is removable with flanges that extend down into the jar to prevent dripping into the warmer. The bottom piece is also removable.

92230

Code	4124801
Power	100 watts
Voltage	240V
Capacity	2.8 L
Dimension (l x d x h)	35.3 x 23.2 x 30.3 cm
Weight	2.68 kg



ColdFest® Gastronorm Pans & Crocks

- Keeps contents chilled at or below HACCP guidelines of without the use of messy ice.
- Freeze upside down for eight hours or overnight before filling with pre-chilled product.
- Half and third-size pans hold contents cold for up to eight hours. Sixth size pans and crocks hold contents cold for up to six hours.
- Conforms to Gastronorm exterior dimensions to fit standard food bars or make tables.
- Stackable to save space when freezing and storing.
- Can be used for direct food contact with all types of food products



	26CF	36CF	66CF	CFR18	CFRSC18
PRODUCT CODE	4124901	4124902	4124903	4124904	4124905
CAMBRO CODE	26CF	36CF	66CF	CFR18	CFRSC18
TYPE	GN 1/2 Size	GN 1/3 Size	GN 1/6 Size	17.3cm	SEAL COVER
DIMENSION (w x d x h cm)	26.5 x 32.5 x 15	17.6 x 32.5 x 15	16.2 x 17.6 x 15	17.3 x 17	17.3
CAPACITY	6 L	3.5 L	1.4 L	1.6L	-

Pump with cover for CFR18 ColdFest® Crocks Only



	CFPSRC10	CFPMRC10	CFPFRC10
PRODUCT CODE	4125501	4125502	4125503
CAMBRO CODE	26CF	36CF	66CF
DESCRIPTION	Standard Pump dispense	Maxi Pump for chunky condiments	Fixed Nozzle Pump for controlled dispensing
DIMENSION (w x d x h cm)	18.4 x 22.8 x 28.5	18.4 x 26 x 31.4	18.4 x 29.5 x 29.8
CAPACITY	1oz Per Portion	chunky condiments	controlled dispensing



Sturdy Baby Chair Seating, No Wheels 婴儿椅

CODE	SIZE (w x d x h cm)
4123602-xx	59.7 x 59.7 x 75.6

Tray Only Platinum Sturdy Chair 婴儿椅托

CODE	SIZE (w x d x h cm)
4123603	47 x 29 x 8.2

*Available Colour

■ BK ■ GY

When ordering Black colour, add **CODE** suffix to item number (example: 4123602-BK)

Wooden Baby Chair 木制婴儿椅

CODE	SIZE (w x d x h cm)
4123604-xx	50 x 50 x 69

*Available Colour

■ WN ■ NW

When ordering Clear colour, add **CODE** suffix to item number (example: 4123600-BR)

Safety Strap 4123605



Plastic Baby Booster Seat 婴儿座垫

CAMBRO

CODE	SIZE (w x d x h cm)	REMARK
4123600-xx	29.5 x 28.6 x 20.6	Without Strap
4123601-xx	29.5 x 28.6 x 20.8	With Strap

*Available Colour

■ BR ■ BG

When ordering Dark Brown colour, add **CODE** suffix to item number (example: 4123600-BR)





Inverted Sauce Dispenser

Code	4125100
Capacity	5.5 L
Dimension (l x d x h)	17 x 17 x 56 cm

Stand

Code	4125101
Dimension (l x d x h)	34.5 x 30.0 x 60.0 - 90.0 cm (min) (max)



Plastic Plate Clips

盘杯夹

CODE	CAP
------	-----

4125001	White
4125002	Black



Condiment Salt & Pepper Shaker / Chiller Container / Squeeze Bottles & Accessories 酱料/辣椒/调味储存瓶和罐

Acrylic Pepper Shaker



	8001	8002	8004	8043	8076
PRODUCT CODE	4126001	4126002	4126003	4126004	4126005
CAPACITY (ml)	60	30	50	35	30
DIMENSION (d x h cm)	4.2 x 8.9	4.2 x 5.2	4.2 x 10	5 x 7.5	4.5 x 7.5
PER CARTON QTY	144	288	144	144	288
COLOUR	S/steel Top	S/steel Top	S/steel Top	S/steel Top	S/steel Top

Acrylic Pepper Shaker & Sugar Caddy



	8119	8003	8330	RP-146	RP-147	RP-148
PRODUCT CODE	4126006	4126007	4126008	4126009	4126010	4126011
CAPACITY (ml)	75	-	-	-	-	-
DIMENSION (l x w x h cm)	4.9 x 9.3	8 x 5.5 x 5.2	11 x 6.5 x 5.5	8 x 6 x 5	8 x 6 x 5	8 x 6 x 5
PER CARTON QTY	144	144	160	72	72	72
COLOUR	Clear Top	Clear	Clear	White	Black	Clear

Acrylic Oil & Soya Dispenser



	8016	8033	8034	8309-R	8308-R
PRODUCT CODE	4126012	4126013	4126014	4126015	4126016
CAPACITY (ml)	75	138	213	300	500
DIMENSION (d x h cm)	7.3 x 12	11 x 7 x 8	14.5 x 8 x 9	7.4 x 13.5	8.7 x 16.7
PER CARTON QTY	72	72	72	72	48
COLOUR	Clear Top	Clear Top	Flat Top	Red Top	Red Top

FOOD SERVICE & BUFFET WARE

Acrylic Oil & Soya Dispenser



	8108	8109	8110	8111
PRODUCT CODE	41260017	4126018	4126019	4126020
CAPACITY (ml)	240	190	108	75
DIMENSION (d x h cm)	6.4 x 15.1	6 x 13.5	5.5 x 12	5.4 x 9.2
PER CARTON QTY	72	72	72	144
COLOUR	Clear Top	Clear Top	Clear Top	Clear Top

Acrylic Oil & Soya Dispenser



	8012	8013	8014
PRODUCT CODE	4126021	4126022	4126023
CAPACITY (ml)	225	150	213
DIMENSION (d x h cm)	6.6 x 12.5	6 x 11	14.5 x 8 x 9
PER CARTON QTY	72	72	72
COLOUR	Brown Top	Brown Top	Brown Top

Chilli Sauce / Flake Container



	8206	8210	8211	8045	8047	8031
PRODUCT CODE	4126024	4126025	4126026	4126027	4126028	4126029-XX
CAPACITY (ml)	320	400	200	138	200	250
DIMENSION (d x h cm)	9 x 9.6	11 x 10.5	8.6 x 7.7	7.5 x 8.5	8 x 9.7	7.7 x 10
PER CARTON QTY	48	48	96	72	72	72
COLOUR	Clear Top	Clear Top	Clear Top	Clear Top	Clear Top	Red & Yellow Top

* Available Colour for 8031 (red & Yellow)

Toothpick Holder



	8007	8122	8075	8030	8018
PRODUCT CODE	4126030	4126031	4126032	4126033	4126034
CAPACITY (ml)	-	-	-	-	-
DIMENSION (d x h cm)	5 x 8	5 x 5 x 8.5	4.5 x 7.5	5 x 8.5	5 x 9.5
PER CARTON QTY	144	192	288	144	144
COLOUR	Clear Top	Square Clear	S/steel Top	Red Rim	Brown Top

Condiment Holder



	8063	8046	8117
PRODUCT CODE	4126035	4126036	4126037
CAPACITY (ml)	-	-	-
DIMENSION (d x h cm)	13 x 6.5 x 12	18.2 x 19	27 x 11 x 2
PER CARTON QTY	72	72	72
COLOUR	S/steel Handle	S/steel Handle	Clear

Condiment Holder

Chopstick Holder



	8049	8420	8017	9051
PRODUCT CODE	4126038	4126039	4126040	4126041
CAPACITY (ml)	-	-	-	-
DIMENSION (d x h cm)	28.5 x 15.8 x 1.7	23.8 x 15.8 x 2.1	26.9 x 10.8 x 1.9	29.5 x 11.2 x 6
PER CARTON QTY	144	120	72	12
COLOUR	Clear	Clear	Brown	Clear

Polycarbonate Shakers / Dredges



	96SKRD	96SKRC	96SKRM
PRODUCT CODE	4126042	4126043	4126044
CAPACITY (ml)	300	300	300
DIMENSION (d x h cm)	10.5 x 9.6	10.5 x 9.6	10.5 x 9.6xx
USE FOR	Salt & Pepper	Cheese Lid	Medium Gound
COLOUR	Beige Lid	Yellow Lid	Rose Lid

SAN Condiment J-Jar



	CJ-07
PRODUCT CODE	4126045
CAPACITY (ml)	240
DIMENSION (d x h cm)	10.2 x 8.3
USE FOR	Cheese / Chilli
COLOUR	Clear Lid

FOOD SERVICE & BUFFET WARE

Glass Salt & Pepper Shakers



	150SP	151SP	156SP	158GD	158S	RG-7
PRODUCT CODE	4126101	4126102	4126103	4126104	4126105	4126106
CAPACITY (ml)	30	60	180	30	30	30
DIMENSION (d x h cm)	3.5 x 7.5	4.6 x 9.0	5.0 x 12.0	4.6 x 11.2	4.5 x 11.2	4.5 x 11.0
PER CARTON QTY						
COLOUR	S/steel Top	S/steel Top	S/steel Top	Gold Plated Top	Chrome Top	S/steel Top

Glass Salt & Pepper Shakers



	30SP	RG-16	802X	803X	800CS
PRODUCT CODE	4126107	4126108	4126109	4126110	4126111
CAPACITY (ml)	15	60	180	180	360
DIMENSION (d x h cm)	2.8 x 5.0	3.8 x 10.0	6.7 x 9.0	6.7 x 9.0	7.8 x 13.8
PER CARTON QTY					
COLOUR	S/steel Top	S/steel Top	Perforated Top	Slotted Top	S/steel Top

Cheese & Chilli Flake Shaker

Glass Sugar Shakers / Pourers



	RG-11	RG-12	600S
PRODUCT CODE	4126112	4126113	4126114
CAPACITY (ml)	360	360	180
DIMENSION (d x h cm)	7.5 x 13.4	7.2 x 14.2	5.4 x 14.8
PER CARTON QTY			
COLOUR	S/steel Top	S/steel Top	S/steel Top

Oil & Vinegar Bottles

Squeeze Bottles



SDM24-BL
4126224-XX



SDHL-3 Holder
4126200

PRODUCT CODE	4126224-XX	4126200
CAPACITY (oz)	24	
DIMENSION (d x h cm)	29.2 x 8.8 x 8.8	
PER CARTON QTY	12	12
COLOUR	<input type="checkbox"/> RD <input type="checkbox"/> YL <input type="checkbox"/> BL <input type="checkbox"/> GN	



3332
4126332



4916
4126416-XX



4924
4126424-XX



4932
4126432

PRODUCT CODE	4126332	4126416-XX	4126424-XX	4126432
CAPACITY (oz)	32	16	24	32
DIMENSION (d x h cm)	8.5 x 25.4	7.4 x 18.7	7.3 x 26	8.2 x 26.3
PER CARTON QTY	12	12	12	12
COLOUR	<input type="checkbox"/> CL	<input type="checkbox"/> RD <input type="checkbox"/> YL <input type="checkbox"/> CL	<input type="checkbox"/> RD <input type="checkbox"/> CL	<input type="checkbox"/> CL

For Plating Decoration



B100
4126508-XX



B101
4126512-XX



B102
4126524-XX



116434
4126608

PRODUCT CODE	4126508-XX	4126512-XX	4126524-XX	4126608
CAPACITY (oz)	8	12	24	8.5
DIMENSION (d x h cm)	5.0 x 18.0	6.0 x 22.0	7.0 x 25.5	6.0 x 19.5
PER CARTON QTY				
COLOUR	<input type="checkbox"/> RD <input type="checkbox"/> YL <input type="checkbox"/> CL	<input type="checkbox"/> RD <input type="checkbox"/> YL <input type="checkbox"/> CL	<input type="checkbox"/> RD <input type="checkbox"/> YL <input type="checkbox"/> CL	<input type="checkbox"/> CL



Wooden Service Trolley
木服务车

CODE	SIZE (l x w x h cm)
4130603	74 x 45 x 81



**Stainless Steel Roast
Beef Wagon Trolley**
烤牛肉车

CODE	SIZE (l x w x h cm)
4130500	90 x 56 x 110



Flambe Trolley (Portable Burner)
单炉餐车

CODE	SIZE (l x w x h cm)
4130703	95 x 47 x 81

* Portable gas stove are sold separately under code 5160500



Flambe Trolley (Double Burner)
双炉餐车

CODE	SIZE (l x w x h cm)
4130800	106 x 48 x 88

CODE	PAGE	CODE	PAGE	CODE	PAGE	CODE	PAGE	CODE	PAGE	CODE	PAGE	CODE	PAGE
1907	406,	28159	427	645789	773	1010150	10	1012324	13	1020440	16	1030340	19
	407, 410	28166	426	645790	773	1010216	10	1012328	13	1020445	16	1030345	19
1933	409,	28172	426	646319	773	1010220	10	1012416	13	1020450	16	1030350	19
	411,	28173	426	646321	773	1010224	10	1012420	13	1020516	17	1030416	19
	412, 414	28174	411, 427	646792	715	1010228	10	1012424	13	1020518	17	1030418	19
2023	411	28175	411, 427	647405	773	1010232	10	1012428	13	1020520	17	1030420	19
27046	426	28176	411, 427	647551	715	1010236	10	1012524	13	1020524	17	1030422	19
27047	426	28177	411, 427	647923	773	1010240	10	1012528	13	1020528	17	1030424	19
27048	426	28178	411, 427	647924	773	1010245	10	1012620	13	1020612	17	1030426	19
27051	426	28179	427	647933	773	1010250	10	1012624	13	1020614	17	1030428	19
27066	426	28180	427	647934	773	1010316	10	1012628	13	1020616	17	1030430	19
27067	426	28181	427	648307	771	1010320	10	1012632	13	1020618	17	1030516	20
27068	426	28194	411	648308	771	1010324	10	1012636	13	1020620	17	1030518	20
27069	426	28195	426	648309	771	1010328	10	1012640	13	1020624	17	1030522	20
27070	426	28196	426	648808	773	1010332	10	1012716	13	1020628	17	1030524	20
27072	426	28197	427	648809	773	1010336	10	1012718	13	1020716	17	1030526	20
27078	426	28198	411, 427	648822	773	1010340	10	1012720	13	1020718	17	1030528	20
27079	426	28199	411, 427	648823	773	1010345	10	1012722	13	1020720	17	1030530	20
27080	426	39726	427	649059	771	1010350	10	1012724	13	1020722	17	1030620	20
27081	426	39881	427	649220	773	1010424	11	1013008	15	1020724	17	1030622	20
27086	426	003583	773	649223	773	1010428	11	1013010	15	1020820	18	1030624	20
27087	426	004345	773	649801	715	1010432	11	1013012	15	1020824	18	1030626	20
27113	407, 427	005786	773	649802	715	1010436	11	1013014	15	1020826	18	1030628	20
27114	407, 427	101230	427	649803	715	1010440	11	1013016	15	1020828	18	1030640	20
27116	427	370398	538	649815	715	1010445	11	1013110	15	1020832	18	1030736	20
27117	427	550267	538	649816	715	1010450	11	1013112	15	1020836	18	1030740	20
27130	426	550289	538	649817	715	1010516	11	1013114	15	1020840	18	1040116	21
27148	426	550658	543	649834	715	1010520	11	1013116	15	1020920	18	1040120	21
27149	426	550971	543	649835	715	1010524	11	1013208	15	1020924	18	1040124	21
27150	426	568489	543	649836	715	1010528	11	1013210	15	1020926	18	1040126	21
27164	426	573243	539	649852	715	1010616	11	1013212	15	1020928	18	1040132	21
27191	426	573244	539	649853	715	1010620	11	1013214	15	1020932	18	1040136	21
27219	426	573245	539	649855	715	1010624	11	1013216	15	1020936	18	1040140	21
27244	426	573246	539	649855	773	1010628	11	1013310	15	1020940	18	1040150	21
27245	426	573248	540	649861	715	1010724	11	1013312	15	1021020	17	1040214	21
27298	407, 427	573249	540	649863	715	1010728	11	1013314	15	1021024	17	1040220	21
27511	426	573250	540	649863	773	1010732	11	1013316	15	1021026	17	1040226	21
27555	426	573251	540	650357	773	1010916	11, 13	1013410	15	1021028	17	1040234	21
27566	426	573252	543	650358	773	1010920	11, 13	1013412	15	1021032	17	1040240	21
27577	426	573254	543	650386	773	1010924	11, 13	1013414	15	1021036	17	1040260	21
27588	426	573255	541	650387	773	1010928	11, 13	1013510	15	1021040	17	1040315	21
27599	426	573256	541	650448	771	1010932	11, 13	1013512	15	1021116	17	1040318	21
27610	426	573257	541	650449	771	1010936	11, 13	1013514	15	1021118	17	1040324	21
27621	426	573258	543	650449	772	1010940	11, 13	1013516	15	1021120	17	1040328	21
27632	426	573259	541	650450	771	1010945	11, 13	1013608	15	1021122	17	1040335	21
27764	426	573260	543	650476	771	1010950	11, 13	1013610	15	1021124	17	1040340	21
27786	426	573261	543	650477	771	1011920	12	1013612	15	1021128	17	1040416	21
28004	426	573264	542	650478	771	1011924	12	1013614	15	1021132	17	1040420	21
28016	426	573266	542	650492	772	1011928	12	1013616	15	1021136	17	1040500	21
28051	426	573269	543	650494	772	1011932	12	1020120	16	1021140	17	1040736	21
28052	426	573311	543	650496	772	1011936	12	1020122	16	1021145	17	1040755	21
28053	426	573458	542	650501	772	1011940	12	1020124	16	1021150	17	1040760	21
28054	426	573513	543	650503	772	1011945	12	1020128	16	1021160	17	1040780	21
28055	426	573570	538	650556	772	1011950	12	1020132	16	1021220	18	1060118	22
28056	426	573825	542	650667	772	1012016	12	1020136	16	1021236	18	1060120	22
28057	426	573973	536	650669	770	1012020	12	1020140	16	1021240	18	1060125	22
28058	426	573974	536	650671	770	1012024	12	1020145	16	1021328	18	1060130	22
28059	426	573975	536	650678	770	1012028	12	1020150	16	1021336	18	1060136	22
28060	426	573976	536	650745	770	1012032	12	1020155	16	1021416	18	1060218	22
28061	426	573977	538	650863	770	1012036	12	1020220	16	1030120	19	1060220	22
28062	426	573978	538	650878	772	1012040	12	1020222	16	1030125	19	1060225	22
28063	426	573979	538	650898	772	1012045	12	1020224	16	1030128	19	1060230	22
28064	426	616258	773	650900	772	1012050	12	1020228	16	1030130	19	1060236	22
28065	426	616259	773	650927	770	1012116	12	1020232	16	1030132	19	1060318	23
28066	426	638792	773	650928	770	1012124	12	1020236	16	1030136	19	1060320	23
28067	426	638793	773	650929	770	1012128	12	1020240	16	1030140	19	1060325	23
28068	426	640598	771	650930	770	1012132	12	1020245	16	1030145	19	1060330	23
28069	426	641010	771	650931	770	1012136	12	1020250	16	1030150	19	1060336	23
28073	426	641316	771	650932	770	1012140	12	1020260	16	1030155	19	1060418	23
28101	426	642035	771	650933	770	1012145	12	1020320	16	1030160	19	1060420	23
28110	427	642500	771	650934	770	1012150	12	1020322	16	1030230	19	1060425	23
28111	427	644282	715	650957	771	1012224	12	1020324	16	1030232	19	1060430	23
28112	427	644293	715	651034	772	1012228	12	1020328	16	1030236	19	1060436	23
28113	427	644303	773	1010120	10	1012232	12	1020332	16	1030240	19	1060628	23
28114	427	644387	773	1010124	10	1012236	12	1020336	16	1030245	19	1060636	23
28115	427	644836	773	1010128	10	1012240	12	1020340	16	1030250	19	1070130	24
28134	427	644837	773	1010132	10	1012245	12	1020345	16	1030255	19	1080136	24
28135	427	644986	771	1010136	10	1012250	12	1020350	16	1030260	19	1080235	24
28153	426	645051	715	1010140	10	1012316	13	1020432	16	1030332	19	1080314	24
28158	427	645215	771	1010145	10	1012320	13	1020436	16	1030336	19	1080316	24

CODE	PAGE	CODE	PAGE	CODE	PAGE	CODE	PAGE	CODE	PAGE	CODE	PAGE	CODE	PAGE
1080318	24	1100228	28	1141019	48	1151206	51	1181213	54, 59	1230136	25	1243453	42
1080320	24	1100326	28	1141021	47	1151206	51	1181214	55, 60	1230146	25	1251300	46
1080322	24	1100328	28	1141023	47	1151210	51	1181216	55, 60	1230150	25	1251305	46
1080324	24	1100330	28	1141106	48	1151215	51	1181219	56, 60	1230160	25	1251601	46
1080326	24	1100332	28	1141110	48	1151306	51	1181312	54	1230180	25	1251842	46
1080420	24	1120208	53, 307	1141115	48	1151411	49, 50,	1181313	56	1240114	32, 38,	1260110	718
1080424	24	1120210	53, 307	1141120	48		51	1181315	56		183	1260216	718
1080428	24	1120212	53, 307	1150102	49	1151412	49, 50	1181316	55	1240116	32, 38,	1260320	719
1080432	24	1120214	53, 307	1150104	49	1151413	50	1181323	56		183	1260428	719
1080436	24	1120216	53, 307	1150106	49	1151414	50	1181325	56	1240118	32, 38,	1260530	718
1080440	24	1120218	53, 307	1150110	49	1151416	50	1181333	56		183	1260628	718
1080445	24	1120220	53, 307	1150115	49	1151420	51	1181335	56	1240120	32, 38,	1260728	718
1080450	24	1120222	53, 307	1150120	49	1151421	49, 50	1181363	56		183	1260736	718
1080518	25	1120224	53, 307	1150202	49	1151423	49, 51	1181365	56	1240124	32, 38,	1260824	719
1080520	25	1120227	53, 307	1150204	49	1160111	51	1181412	54		183	1260930	719
1080522	25	1120230	53, 307	1150206	49, 725,	1160112	51	1181413	55	1240128	32, 38,	1261030	719
1080524	25	1120314	53		733,	1160113	51	1181416	55		183	1261116	719
1080526	25	1120318	53		739,	1160121	51, 219	1181513	55	1240214	37	1300110	59
1080528	25	1130107	53		749, 751	1160211	51	1190711	61	1240216	37	1300115	59
1080530	25	1130116	53	1150210	49, 733,	1160212	51	1190712	61	1240218	37	1300206	59
1080532	25	1130123	53		739,	1160326	51	1190713	62	1240220	37	1300215	59
1080536	25	1130207	53		749, 751	1160352	51	1190714	62	1240320	37	1300306	59
1080540	25	1130216	53	1150215	49	1160400	51	1190716	62	1240324	37	1300310	59
1080545	25	1130223	53	1150220	49	1170102	52	1190719	62	1240420	37	1300315	59
1080550	25	1130305	53	1150302	49	1170104	52	1190811	61	1240424	37	1300406	60
1080618	25	1130307	53	1150306	49, 725,	1170107	52	1190812	61	1240520	37	1300410	60
1080620	25	1130316	53		727,	1170111	52	1190813	62	1240524	37	1300415	60
1080622	25	1130411	53		733,	1170202	52	1190814	62	1240528	37	1300506	60
1080624	25	1130416	53		735,	1170204	52	1190816	62	1240532	37	1300510	60
1080626	25	1130425	53		739,	1170207	52	1200106	57	1240620	37	1300515	60
1080630	25	1140102	47		743,	1170211	52	1200110	57	1240624	37	1300606	60
1080732	25	1140104	47		749, 751	1170307	52	1200115	57	1240628	37	1300610	60
1080736	25	1140106	47	1150310	49, 733,	1170311	52	1200120	57	1240632	37	1310211	59
1080838	25	1140110	47		735,	1170401	52	1200206	57	1240716	37	1310212	59
1080920	26	1140115	47		739,	1170402	52	1200210	57	1240720	37	1310213	59
1080924	26	1140202	47		743,	1170403	52	1200215	57	1240724	37	1310214	60
1080928	26	1140204	47		749, 751	1170404	52	1200220	57	1240728	37	1310216	60
1080932	26	1140206	47	1150315	49	1170406	52	1200306	57	1240824	38	1310219	60
1080936	26	1140210	47	1150320	49	1170408	52	1200310	57	1240932	38	1310313	59
1081120	26	1140215	47	1150402	49	1170412	52	1200315	57	1240933	38	1310316	60
1081124	26	1140220	47	1150404	49	1170501	52	1200320	57	1241009	38	1320211	59
1081126	26	1140302	47	1150406	49, 726,	1170502	52	1200406	58	1241010	38	1320212	59
1081128	26	1140304	47		734, 741	1170503	52	1200410	58	1241012	38	1320213	59
1081130	26	1140306	47	1150410	49, 734,	1170504	52	1200415	58	1241014	38	1320214	60
1081132	26	1140310	47		741	1170506	52	1200506	58	1241110	38	1320216	60
1081136	26	1140315	47	1150415	49	1170508	52	1200510	58	1241210	38	1320219	60
1081140	26	1140320	47	1150506	50, 726,	1170512	52	1200515	58	1241328	38	2010103	64
1081222	26	1140402	47		734, 741	1180711	54	1200606	58	1241909	38	2010104	64
1081226	26	1140404	47	1150510	50, 734,	1180712	54	1200610	58	1242016	40	2010106	64
1081230	26	1140406	47		741	1180713	55	1200706	58	1242024	40	2010108	64
1081336	26	1140410	47	1150515	50	1180714	55	1200710	58	1242028	40	2010112	64
1081338	26	1140415	47	1150520	50	1180716	55	1200715	58	1242032	40	2010115	64
1081436	27	1140420	47	1150606	50	1180718	56	1210111	57	1242036	40	2010118	64
1081440	27	1140506	48	1150610	50	1180811	54	1210112	57	1242120	40	2010121	64
1081512	27	1140510	48	1150615	50	1180812	54	1210113	57	1242124	40	2010130	64
1081514	27	1140515	48	1150620	50	1180813	55	1210114	58	1242240	40	2010136	64
1081612	26	1140520	48	1150706	50	1180814	55	1210116	58	1242246	40	2010140	64
1081720	27	1140606	48	1150710	50	1180816	55	1210118	58	1242338	40	2010206	64
1081724	27	1140610	48	1150715	50	1180818	56	1210119	58	1242416	40	2010208	64
1081728	27	1140615	48	1150720	50	1180911	54	1210211	57	1242528	40	2010210	64
1081820	27	1140620	48	1150806	50	1180912	54	1210212	57	1242620	41	2010212	64
1081824	27	1140706	48	1150810	50	1180913	55	1210213	57	1242624	41	2010215	64
1081828	27	1140710	48	1150815	50	1180916	55	1210214	58	1242628	41	2010218	64
1081832	27	1140715	48	1150902	50	1180919	56	1210216	58	1242632	41	2010221	64
1081836	27	1140802	48	1150906	50	1181011	54	1210218	58	1242724	41	2010230	64
1081840	27	1140806	48	1150910	50	1181012	54	1220136	24	1242728	41	2010236	64
1082028	28	1140810	48	1150915	50	1181013	55	1220140	24	1242916	41	2010240	64
1082150	29	1140815	48	1151002	50	1181014	55	1220211	57	1242920	41	2010306	64
1082162	29	1140820	48	1151006	50	1181016	55	1220212	57	1242924	41	2010308	64
1100116	28	1140902	48	1151010	50	1181018	56	1220213	58	1242928	41	2010310	64
1100118	28	1140904	48	1151015	50	1181019	56	1220214	58	1242932	41	2010312	64
1100120	28	1140906	48	1151111	49, 50,	1181111	54	1220216	58	1242936	41	2010315	64
1100124	28	1140910	48		51	1181112	54	1220218	58	1243020	41	2010318	64
1100126	28	1140915	48	1151112	49, 50	1181113	55	1220219	58	1243126	41	2010321	64
1100128	28	1140920	48	1151113	50	1181114	55	1220235	24	1243220	42	2010330	64
1100130	28	1141011	47, 48	1151114	50	1181116	55	1220240	24	1243236	42	2010336	64
1100132	28	1141012	47, 48	1151116	50	1181118	56	1230100	25	1243243	42	2010405	64
1100220	28	1141013	48	1151120	51	1181119	56	1230124	25	1243324	42	2010406	64
1100224	28	1141014	48	1151121	49, 50	1181211	54, 59	1230128	25	1243336	42	2010408	64
1100226	28	1141016	48	1151123	49, 51	1181212	54, 59	1230132	25	1243350	42	2010410	64

CODE	PAGE	CODE	PAGE	CODE	PAGE	CODE	PAGE	CODE	PAGE	CODE	PAGE	CODE	PAGE
2010412	64	2030340	67	2060527	71, 186,	2081521	74	2103300	79		188	2150150	89, 194
2010415	64	2030353	67, 223		317	2081524	74	2103400	79	2120224	82, 188	2150225	89
2010421	64	2030360	223	2060530	71, 186,	2081600	74	2110106	83	2120233	82, 188	2150230	89
2010430	64	2030365	67, 223		317	2081707	73	2110107	83	2120240	82, 188	2150235	89
2010625	64	2030440	67, 223	2060533	71, 186,	2081708	73	2110108	83	2120325	82, 188	2150240	89
2010630	64	2030453	67, 223		317	2081710	73	2110109	83	2120330	82, 188	2150245	89
2010635	64	2030460	67, 223	2060536	186, 317	2081712	73	2110110	83	2120335	82, 188	2150250	89
2010640	64	2030465	67, 223	2060539	186, 317	2081714	73	2110112	83	2120340	82	2150325	89
2010703	64	2030540	67, 223	2060542	186, 317	2081718	73	2110114	83	2120350	82	2150330	89
2010704	64	2030553	67, 223	2060545	186, 317	2081720	74	2110116	83	2120412	82, 188	2150335	89
2010706	64	2030560	223	2060550	186, 317	2081722	73	2110118	83	2120415	82, 188	2150340	89
2010708	64	2030565	67	2060555	186, 317	2090108	75	2110120	83	2120510	82, 188	2150345	89
2010710	64	2030640	67, 223	2060560	186, 317	2090110	75	2110200	83	2120512	82, 188	2150425	194
2010712	64	2030653	67, 223	2060612	71, 318	2090112	75	2110201	83	2120514	82, 188	2150430	194
2010715	64	2030660	223	2060614	71, 318	2090114	75	2110202	83	2120516	82, 188	2150435	194
2010718	64	2030665	67	2060616	71, 318	2090116	75	2110203	83	2120518	82, 188	2150440	194
2010806	64	2030740	67, 223	2060618	71	2090216	75	2110204	83	2120520	82, 188	2150445	194
2010808	64	2030753	67, 223	2060620	71, 318	2090218	75	2110206	83	2120532	82, 188	2150510	88, 194,
2010810	64	2030760	67, 223	2060622	71, 318	2090220	75	2110208	83	2120539	82, 188		354
2010812	64	2030765	67, 223	2060624	71, 318	2090224	75	2110401	83	2120610	82, 188	2150512	88, 194,
2010803	64	2031211	319	2060626	318	2090315	75	2110402	83	2120614	82, 188		354
2010804	64	2040103	68, 391	2060628	318	2090317	75	2110403	83	2120616	82, 188	2150514	88, 194,
2010815	64	2040104	68, 391	2060630	318	2090320	75	2110404	83	2120710	188		354
2010818	64	2040105	68, 391	2060632	318	2090322	75	2110409	83	2120714	82, 188	2150516	88, 194,
2010930	65	2040114	68, 391	2060634	318	2090416	76	2110411	83	2120716	188	2150518	88, 194,
2010935	65	2040116	68, 391	2060636	318	2090516	76	2110414	83	2120810	82, 188		354
2010940	65	2040203	68	2060638	318	2090609	75	2110418	83	2120814	82, 188	2150610	88, 194,
2010945	65	2040204	68	2060716	71, 186	2090611	75	2110418	83	2120816	82, 188		354
2010950	65	2040205	68	2060718	71, 186	2090612	76, 314	2110427	83	2120910	82, 188	2150612	88, 194,
2010955	65	2040206	68	2060720	71, 186	2090709	76, 314	2110436	83	2120914	82, 188		354
2011040	65	2040303	69, 683	2060722	71, 186	2090713	76, 314	2110454	83	2120916	82, 188	2150614	88, 194,
2011045	65	2040304	69, 683	2060724	71, 186	2090717	76, 314	2110527	86	2121010	82, 188		354
2011340	65	2040305	69, 683	2060726	71, 186	2090800	76	2110627	86	2121014	82, 188	2150616	88, 194,
2011345	65	2040306	69, 683	2060728	71, 186	2090821	76	2110727	86	2121016	82, 188		354
2011435	65	2040413	69	2070132	72	2090824	76	2110827	87	2130115	81, 193	2150618	88, 194,
2011440	65	2040516	69	2070136	72	2090829	76	2110833	87	2130120	81, 193		354
2011445	65	2040616	70	2070140	72	2090900	76	2110838	87	2130125	81, 193	2150620	88, 194,
2011535	65	2040716	70	2070150	72	2100108	78	2110928	87	2130130	81, 193		354
2011540	65	2041001	68	2070225	71	2100111	78	2110933	87	2130135	81, 193	2150622	88, 194,
2011545	65	2041002	68	2070230	71	2100211	78	2110938	87	2130215	81, 193		354
2011635	65	2041003	68	2070235	71	2100313	78	2111028	87	2130220	81, 193	2150624	88, 194,
2011640	65	2041004	68, 69	2070240	71	2100314	78	2111028	87	2130225	81, 193		354
2011645	65	2041006	68, 69	2070328	72	2100315	78	2111033	87	2130230	81, 193	2150712	89, 194
2011701	65	2041108	69	2070336	72	2100400	78	2111033	87	2130235	81, 193	2150714	89, 194
2011702	65	2050115	70, 319	2070339	72	2100500	78	2111038	87	2130315	81, 193	2150718	194
2011703	65	2050133	70, 319	2070419	72, 390	2100600	78	2111038	87	2130320	81, 193	2150808	90
2011801	65	2050150	70, 319	2070421	72, 390	2100700	78	2111128	87	2130325	81, 193	2150810	90
2020101	66, 221	2050215	70, 319	2070424	72, 390	2101200	80	2111133	87	2130330	81, 193	2150812	90
2020102	66, 221	2050233	70, 319	2070427	72, 390	2101300	80	2111138	87	2130335	81, 193	2150814	90
2020201	66, 221	2050250	70, 319	2070430	72, 390	2101400	80	2111200	86	2130362	90	2150816	90
2020202	66, 221	2050315	70, 319	2070433	72, 390	2101500	80	2111300	86	2130415	81, 193	2150818	90
2020500	66, 221,	2050333	70, 319	2070436	72, 390	2101600	80	2111442	86	2130420	81, 193	2151048	89
	346	2050350	70, 319	2080124	73	2101700	80	2111529	86	2130425	81, 193	2151068	89
2020600	66, 221,	2050430	70, 195	2080125	73	2101800	80	2111802	84	2130430	81, 193	2151110	90
	346	2050500	70, 319	2080126	73	2101900	80	2111804	84	2130435	81, 193	2151112	90
2020700	66, 221	2050501	70, 319	2080130	73	2102002	80, 651	2111806	84	2130810	81, 192	2151114	90
2020701	66, 221	2050502	70, 319	2080214	73, 391	2102003	80, 651	2111808	84	2130909	81, 192	2151116	90
2020710	82	2050600	70, 319	2080705	73	2102005	80, 651	2111902	84	2130913	79, 193	2151118	90
2020716	82	2050601	70, 319	2080707	73	2102006	80, 651	2111904	84	2140124	83	2151120	90
2020800	66, 221	2050602	70, 319	2080710	73	2102007	80, 651	2111906	84	2140142	83	2151122	90
2020801	66, 221	2050715	70, 195,	2080815	73	2102010	80, 651	2111908	84	2140148	83	2151124	90
2020900	67, 222		319	2080817	73	2102012	80, 651	2112002	84	2140154	83	2151200	89, 194
2021111	67, 222	2050730	70, 195,	2080820	73	2102015	80, 651	2112004	84	2140160	83	2160102	90, 197
2021112	67, 222		319	2080825	73	2102020	80, 651	2112006	84	2140218	83	2160105	90, 197
2021113	67, 222	2051516	354	2081015	73	2102107	80	2112008	84	2140224	83	2160110	90, 197
2021201	66, 221	2060120	71, 186	2081020	73	2102109	80	2112102	84	2140230	83	2160120	90, 197
2021301	66, 221	2060125	71, 186	2081022	73	2102110	80	2112104	84	2140236	83	2160140	90, 197
2030111	68, 219	2060130	71, 186	2081025	73	2102200	80	2112106	84	2140248	83	2160205	90, 197
2030121	68, 219	2060135	71, 186	2081115	73	2102310	80	2112108	84	2140260	83	2160210	90, 197
2030146	68, 219	2060140	71, 186	2081117	73	2102415	29, 78	2112401	85	2140272	83	2160220	90, 197
2030211	68, 219	2060200	71, 186	2081119	73	2102601	78	2112402	85	2140382	83, 383	2160235	90, 197
2030221	68, 219	2060430	72	2081120	73	2102602	78	2112403	85	2140384	83, 383	2160250	90, 197
2030246	68, 219	2060515	71, 186,	2081122	73	2102701	78	2112404	85	2140388	83, 383	2160304	90, 198
2030319	64		317	2081125	73	2102801	78	2112406	85	2140422	83, 383	2160307	90, 198
2030321	64	2060518	71, 186,	2081218	74	2102913	79	2112408	85	2150120	89, 194	2160313	90, 198
2030323	64		317	2081220	74	2102913	79, 193	2120110	29, 82,	2150125	89, 194	2160321	90, 198
2030325	64	2060521	71, 186,	2081222	74	2103013	79, 193		188	2150130	89, 194	2160332	90, 198
2030328	64		317	2081224	74	2103110	81, 192	2120113	29, 82,	2150135	89, 194	2160345	90, 198
2030331	64	2060524	71, 186,	2081226	74	2103200	79		188	2150140	89, 194	2160362	198
2030334	64		317	2081320	74	2103201	79	2120116	29, 82,	2150145	89, 194	2160405	90

CODE	PAGE	CODE	PAGE	CODE	PAGE	CODE	PAGE	CODE	PAGE	CODE	PAGE	CODE	PAGE
2160410	90	2210610	93	2222430	96, 178,	2290302	105	2321235	112, 196	2370300	121	2430133	130
2160415	90	2210611	93		389	2290305	105	2321250	112, 196	2370900	121	2430143	130
2160420	90	2210612	93	2222518	96, 178,	2290312	105	2321270	112, 196	2371100	120	2430146	130
2160505	90	2210616	93		389	2290320	105	2321325	112	2371200	120	2430233	130
2160510	90	2210620	93	2222616	95, 96	2290330	105	2321350	112	2371300	120	2430243	130
2160520	90	2210622	93	2222830	95, 389	2290410	105	2321375	112	2371400	122	2430330	130
2160530	90	2210624	93	2222915	95, 389	2290426	105	2321475	112	2371500	122	2430345	130
2160700	91	2210630	93	2222935	95, 389	2290505	105	2330305	113, 392	2371600	122	2440101	69
2160800	91	2210636	93	2230321	99	2290510	105	2330405	113, 392	2371706	122, 390	2440201	69
2161002	90, 197	2210640	93	2230326	99	2290600	105	2330800	114	2371709	122, 390	2440301	69
2161005	90, 197	2210645	93	2230700	114	2290700	105	2330910	158	2371711	122, 390	2450100	121
2161010	90, 197	2210650	93	2240123	101	2290800	105	2330913	158	2371712	122, 390	2450300	121
2161020	90, 197	2210655	93	2240130	101	2290902	105	2331010	114	2371713	122, 390	2450400	121
2161030	90, 197	2210660	93	2240140	101	2290905	105	2331200	114	2371714	122, 390	2450500	121
2170106	91, 197,	2210665	93	2250224	100	2290912	105	2331315	114	2371802	122, 390	2450600	121
	576, 698	2210670	93	2250324	100	2290920	105	2331400	114	2371803	122, 390	2450700	121
2170112	91, 197,	2210685	93	2250330	100	2290930	105	2331500	114	2371804	122, 390	2450800	121
	576, 698	2210708	93	2250340	100	2300100	106	2331501	114	2371805	122, 390	2450900	121
2170124	91, 197,	2210710	93	2250424	29, 100	2300200	106	2331601	113, 392	2371900	122	2451000	121
	576, 698	2210711	93	2250430	29, 100	2300300	106	2331701	113, 392	2372001	122	3010110	133
2170164	91, 197,	2210712	93	2250440	29, 100	2300500	106	2331801	113	2372002	122	3010213	133
	576, 698	2210716	93	2250524	100	2300501	106	2331802	113	2372003	122	3010216	133
2170205	91, 197,	2210720	93	2250530	100	2300502	106	2331803	113	2372004	122	3010220	133
	698	2210724	93	2250540	100	2300503	106	2340105	128	2380100	123, 388	3010314	133
2170212	91, 197,	2210730	93	2260222	101	2300700	107	2340110	128	2380101	123, 388	3010418	133
	698	2210736	93	2260230	101	2300801	107	2340116	115	2380200	123, 388	3010520	133
2170224	91, 197,	2210740	93	2260240	101	2300908	109	2340205	128	2380300	123	3010618	133
	698	2210750	93	2260322	101	2300912	109	2340210	128	2380400	123, 388	3010720	133
2170238	91, 197,	2210760	93	2260330	101	2301100	109	2340217	115	2380421	123, 388	3010800	159
	698	2210770	93	2260340	101	2301200	109	2340303	128	2380431	123, 388	3010907	135
2170258	91, 197,	2210820	94	2260519	101	2301300	109	2340304	128	2380500	124, 388	3011008	135
	698	2210825	94	2260522	101	2301400	109	2340316	115	2380600	124	3011010	135
2170285	91, 197	2210830	94	2260618	101	2301500	109	2340420	115	2380700	124	3011013	135
2170306	91	2210911	94	2270105	102	2301600	110	2350100	115	2380701	124	3011016	135
2170312	91	2210916	94	2270205	102	2301700	109	2350200	121	2380703	125	3011020	136
2170324	91	2210920	94	2270301	102	2301701	109	2350300	115	2380704	117	3011114	135
2170336	91	2210924	94	2270305	102	2301800	110	2350400	115	2380705	117	3011218	136
2170416	91	2210930	94	2270311	102	2301902	110	2350500	115	2380706	117	3011300	137, 155
2170421	91	2210960	94	2270416	102	2301903	110	2350700	116	2380838	125	3011301	137, 155
2170613	92	2211100	95	2270504	102	2302000	110	2350800	116	2380844	125	3011302	155
2170614	92	2211200	95	2280103	103	2302124	110	2350900	116	2380860	125	3011303	154
2170616	92	2211300	95	2280106	103	2302200	106	2350900	116	2380900	125	3011320	136
2170802	91	2220118	96, 822	2280115	103	2302220	109	2351000	116	2381000	125	3011422	136
2170804	91	2220220	96, 822	2280130	103	2302300	106	2351000	116	2381100	126	3011518	136
2170932	91	2220323	97, 822	2280215	103	2302400	106	2351100	116	2381200	125	3011620	136
2170964	91	2220423	97, 822	2280230	103	2310133	111	2351200	116	2381300	126	3011700	137
2180213	92	2220523	97, 823	2280302	104	2310155	111	2354200	119	2381301	123, 388	3011900	137, 155
2180216	92	2220630	97, 822	2280401	103	2310200	111	2360100	118	2381302	123, 388	3011901	155
2180218	92	2220730	98, 823	2280402	103	2310201	111	2361433	117	2381303	123, 388	3011903	154
2180220	92	2220830	98, 823	2280405	103	2310300	111	2361500	118	2381304	123, 388	3012010	139
2180324	92	2220916	98, 823	2280505	103	2310400	111	2361600	118	2381401	123, 388	3012112	139
2200108	216	2221019	97, 823	2280603	104	2310401	111	2361700	119	2381402	123, 388	3012215	139
2200215	92, 216	2221119	97, 822	2280706	104	2310600	111	2361800	118	2381410	126, 480	3012317	139
2200319	92, 216	2221221	98, 823	2280715	104	2310700	111, 379	2361900	119, 203	2381413	126, 480	3012418	139
2200415	92, 216	2221318	98, 700,	2280730	104	2310800	111,	2362000	119	2381500	123	3012518	139
2200533	92, 216		823	2280801	103		362,	2362100	119,	2381600	124	3012620	139
2210210	94	2221412	98, 823	2280803	103		379, 509		120,	2381700	124	3012720	139
2210212	94	2221518	98, 823	2280807	103	2320125	112,		161, 198	2390100	126	3012820	140
2210216	94	2221617	700	2280815	103		196, 353	2362200	120, 198	2390324	126	3012823	140
2210220	94	2221719	97, 823	2280830	103	2320130	112,	2362410	120, 217	2390331	126	3012827	140
2210224	94	2221850	99	2280915	103		196, 353	2362411	120, 217	2390437	126	3012918	140
2210230	94	2221920	824	2280930	103	2320135	112,	2362500	113	2390510	126	3012920	140
2210312	94	2222021	824	2281102	103		196, 353	2362800	118	2390515	126	3021012	146
2210316	94	2222112	96, 822	2281103	103	2320150	112,	2363210	117	2390520	126	3023200	160
2210320	94	2222118	96	2281260	104		196, 353	2363215	117	2390530	126	3023201	161
2210324	94	2222123	96, 822	2290101	104	2320160	112,	2363218	117	2390540	126	3023330	150
2210330	94	2222130	96, 822	2290102	104		196, 353	2363325	117	2400100	127	3023502	154
2210340	94	2222218	97, 822	2290105	104	2320170	112,	2363330	117	2400200	127	3023503	154
2210416	94	2222223	97, 822	2290110	104		196, 353	2363400	117	2400300	127	3023600	159
2210420	94	2222230	97, 822	2290115	104	2320600	112, 196	2363401	117	2400500	127	3023601	159
2210424	94	2222315	96, 178,	2290120	104	2320601	112, 196	2363500	118	2410110	127, 438	3023602	159
2210430	94		389	2290130	104	2320602	112, 196	2363600	117	2410120	127, 438	3023700	157, 162
2210520	93	2222323	96, 178,	2290150	104	2320815	112, 196	2363800	118	2410320	127	3023701	160, 162
2210530	93		389	2290160	104	2320900	112	2363900	120	2420105	129	3023702	162
2210540	93	2222330	96, 178,	2290201	104	2321000	112	2364000	118	2420110	129	3023703	162
2210604	93		389	2290202	104	2321125	112, 196	2364100	119	2420205	129	3023704	162
2210605	93	2222415	96, 178,	2290205	104	2321135	112, 196	2364400	118	2420210	129	3023705	162
2210606	93		389	2290212	104	2321150	112, 196	2364500	118	2420300	129	3023910	163
2210607	93	2222423	96, 178,	2290220	104	2321170	112, 196	2370100	121	2420500	129	3023915	163
2210608	93		389	2290230	104	2321225	112, 196	2370200	121	2430129	28	3023920	163

CODE	PAGE	CODE	PAGE	CODE	PAGE	CODE	PAGE	CODE	PAGE	CODE	PAGE	CODE	PAGE
3023925	163	3070100	173	3081935	177, 330	4012160	745	4015104	722	4050122	768	4061016	819
3023930	163	3070101	173	3081943	177, 330	4012210	752	4015203	723	4050216	768	4061101	819
3024000	163	3070102	173	3081949	177, 330	4012215	752	4015204	723	4050218	768	4061102	819
3025412	152	3070200	173	3082040	175	4012225	752	4015303	724	4050220	768	4061260	818
3025718	153	3070201	173	3083010	175	4012310	752	4015304	724	4050222	768	4061304	819
3026015	157	3070202	173	3084012	175	4012310	752	4015403	725	4050316	768	4061305	819
3026115	157	3070300	172	3090206	177	4012315	752	4015404	725	4050318	768	4061478	819
3026221	158	3070400	172	3110100	177	4012315	752	4015503	726	4050320	768	4061489	819
3026226	158	3070501	172	3110101	177	4012325	752	4015504	726	4050322	768	4061590	819
3026230	158	3070502	172	3110200	177	4012325	752	4015603	727	4050416	768	4061591	819
3026336	158	3070600	172	3110300	177	4012428	723, 731	4015604	727	4050418	768	4061592	819
3026411	157	3070601	172	3120110	178, 389	4012436	722,	4016111	749	4050420	768	4061601	819
3026415	157	3070602	172	3120112	178, 389		730,	4020104	763	4050422	768	4061602	819
3026423	160	3070735	173	3120212	179		745,	4020106	763	4050516	768	4061603	819
3026523	160	3070863	173	3120220	179		748, 750	4020208	762	4050518	768	4061701	818
3026526	158	3070902	173	3120320	179	4012611	725,	4020308	762	4050520	768	4061702	818
3026534	158	3070904	173	3120422	179, 381		733,	4020414	762	4050522	768	4061703	818
3026536	160	3071000	173	3120500	179		739, 751	4020501	762	4050616	768	4061801	818
3026700	159	3071117	174	3130219	180, 331	4012612	725,	4020610	379, 762	4050618	768	4061802	818
3026906	156	3071212	174	3130224	180, 331		727,	4020620	379, 762	4050620	768	4061803	818
3027008	156	3071215	174	3130322	180, 331		733,	4020704	763	4050622	768	4061901	819
3027026	158	3071300	174	3130416	180,		735,	4020706	763	4050716	768	4061902	819
3027034	158	3071400	174		331, 389		739,	4030101	754	4050718	768	4061903	819
3027110	156	3071500	174	3130418	180,		743,	4030102	755	4050720	768	4070106	817
3027210	156	3071600	174		331, 389		749, 751	4030103	755	4050722	768	4070108	817
3027313	156	3080107	174, 328	3130545	164	4012623	726,	4030106	754	4050816	768	4070110	817
3027413	156	3080108	174, 328	3130550	164		734, 741	4030204	764	4050818	768	4070112	817
3027513	156	3080109	174, 328	3130645	164	4012728	723, 731	4030207	764	4050820	768	4070115	817
3030100	163	3080110	174, 328	3130650	164	4012736	722,	4030306	764	4050822	768	4070118	817
3030101	163	3080111	174, 328	3130700	180		730,	4030404	755	4050916	769	4070123	817
3030102	163	3080112	174, 328	3130823	180, 331		745,	4030503	764	4050918	769	4070410	817
3030103	163	3080113	174, 328	3130900	180		748, 750	4030671	765	4050920	769	4070412	817
3030201	163	3080114	174, 328	3140230	166	4012828	723, 731	4030672	765	4050922	769	4070418	817
3030202	163	3080115	174, 328	3140320	166	4012836	722,	4030673	765	4051012	769	4070506	817
3030203	163	3080116	174, 328	3150220	165		730,	4030700	765	4051016	769	4080713	820
3030206	163	3080117	174, 328	3150230	165		745,	4030814	765	4051026	769	4080913	821
3030207	163	3080118	174, 328	3150330	165		748, 750	4030925	765	4051030	769	4080814	821
3030300	164	3080120	174, 328	3150430	165	4012901	757, 761	4030935	765	4051034	769	4081014	821
3030301	164	3080121	328	3150517	165	4012902	757, 761	4031103	766	4051037	769	4091101	824
3040100	167	3080122	328	3150522	165	4013113	760	4031208	766	4051045	769	4091201	824
3040101	167	3080123	328	3150622	165	4013735	760	4031312	766	4051125	769	4091301	824
3040200	167	3080124	328	3150722	165	4013750	760	4031412	766	4051134	769	4091401	824
3040300	167	3080205	174, 328	4010101	758	4013801	761	4031503	766	4051140	769	4091501	824
3040500	167, 330	3080206	174, 328	4010102	758	4013811	761	4031617	767	4051146	769	4091502	824
3040615	167, 330	3080207	174, 328	4010103	758	4014001	730	4031808	755	4051152	769	4091601	824
3040620	167, 330	3080208	174, 328	4010104	758	4014002	730	4031903	764	4051160	769	4091602	824
3040700	168, 330	3080209	174, 328	4010201	760	4014003	730	4032032	764	4051240	769	4091603	824
3040900	168, 330	3080210	174, 328	4010202	760	4014004	730	4032101	766	4051246	769	4091604	824
3041000	168,	3080211	174, 328	4010203	760	4014101	731	4032102	766	4051252	769	4091701	824
	330, 388	3080212	174, 328	4010204	760	4014102	731	4032425	767	4051260	769	4091702	824
3041100	168,	3080316	175, 328	4010301	759	4014103	731	4032500	767	4052712	811	4091801	824
	330, 388	3080318	175, 328	4010302	759	4014104	731	4032614	767	4052800	812	4091901	824
3041200	168,	3080319	175, 328	4010401	759	4014201	732	4032615	767	4052801	812	4092001	824
	330, 388	3080320	175, 328	4010402	759	4014202	732	4032616	767	4052900	812	4092101	824
3041445	168	3080405	175, 328	4010702	750	4014203	732	4032740	675, 767	4053000	812	4092201	824
3041530	168	3080425	175, 328	4010800	748, 750	4014204	732	4032815	767	4053001	812	4092301	824
3050100	169	3080428	175, 328	4010801	748, 750	4014301	733	4032818	767	4053100	811	4092401	824
3050200	169	3080433	175, 328	4010802	748, 750	4014302	733	4032823	767	4053101	811	4092402	824
3050201	169	3080435	175, 328	4010901	748, 750	4014303	733	4032900	767	4060101	818	4092403	824
3050202	169	3080438	175, 328	4011002	751	4014304	733	4033045	831	4060203	818	4092501	824
3050300	169	3081801	176, 329	4011101	749	4014523	726,	4033046	831	4060305	818	4100102	825
3060207	170	3081802	176, 329	4011102	749, 751		734, 741	4033047	831	4060306	818	4100103	825
3060208	170	3081803	176, 329	4011201	749	4014601	734	4033115	831	4060307	818	4100108	825
3060500	170, 389	3081804	176, 329	4011301	749	4014602	734	4033120	831	4060426	818	4100401	465
3060600	170, 389	3081805	176, 329	4011401	738, 739	4014603	734	4033125	831	4060527	818	4100501	465
3061221	171, 392	3081806	176, 329	4011402	738, 739	4014604	734	4033221	831	4060627	818	4100603	825
3061319	171, 392	3081807	176, 329	4011411	738, 739	4014701	735	4033222	831	4060703	818	4100606	825
3061420	171, 392	3081808	176, 329	4011511	739	4014702	735	4033223	831	4060704	818	4100610	825
3061523	171, 392	3081809	176, 329	4011601	742, 743	4014703	735	4033224	831	4060810	818	4100615	825
3061617	171, 392	3081810	176, 329	4011602	742, 743	4014704	735	4033308	831	4060811	818	4100620	825
3061618	171, 392	3081811	176, 329	4011621	742, 743	4014801	746	4033406	755	4060812	818	4101110	825
3061619	171, 392	3081812	176, 329	4011801	740, 741	4014802	746	4033511	754	4060813	818	4101200	825
3061721	171, 392	3081813	176, 329	4011802	740, 741	4014803	746	4033520	754	4060826	819	4101201	825
3061806	170	3081814	176, 329	4011832	740	4014804	746	4040109	810	4060827	819	4101202	825
3061919	171	3081815	176, 329	4011932	741	4014901	756	4040118	810	4060828	819	4101210	825
3062125	171	3081816	176, 329	4012001	744, 745	4014902	757	4040135	810	4060906	819	4101215	825
3062225	159	3081817	176, 329	4012002	744, 745	4014903	757	4040147	810	4060911	819	4101303	825
3062300	170	3081818	176, 329	4012060	744, 745	4015001	756, 757	4050116	768	4060916	819	4101306	825
3062400	170	3081924	177, 330	4012160	745	4015002	757	4050118	768	4061006	819	4101310	825
3062500	170	3081929	177, 330	4012160	745	4015103	722	4050120	768	4061011	819	4101315	825

CODE	PAGE	CODE	PAGE	CODE	PAGE	CODE	PAGE	CODE	PAGE	CODE	PAGE	CODE	PAGE
4110101	520	4126013	839	4160504	789	4170910	813	5010745	305	5012136	308	5013615	309, 310
4110202	521	4126014	839	4160505	789	4171004	814	5010750	305	5012150	308	5013616	309, 310
4110401	521	4126015	839	4160506	789	4171006	814	5010822	305	5012212	309	5013617	310
4110402	521	4126016	839	4160507	789	4171008	814	5010824	305	5012213	309	5013618	310
4110501	520	4126017	840	4160508	789	4171104	814	5010826	305	5012214	309	5013619	310
4110601	517	4126018	840	4160509	789	4171108	814	5010828	305	5012215	309	5013620	310
4110701	517	4126019	840	4160510	789	4171231	814	5010830	305	5012216	309	5013621	310
4110704	518	4126020	840	4160711	796	4171331	814	5010833	305	5012217	309	5013622	310
4110705	518	4126021	840	4160715	796	4171410	814	5010836	305	5012218	309	5013623	310
4110706	518	4126022	840	4160720	796	4171514	814	5010840	305	5012220	309	5013624	310
4110707	518	4126023	840	4160733	719	4171621	814	5010840	305	5012222	309	5013625	310
4110801	522	4126024	840	4160801	798	4171801	815	5010842	305	5012224	309	5013626	310
4110802	522	4126025	840	4160802	798	4171802	815	5010848	305	5012226	309	5013627	310
4110901	522	4126026	840	4160803	798	4171803	815	5010851	305	5012228	309	5013628	310
4111001	522	4126027	840	4160901	800	4171804	815	5010855	305	5012314	309	5013718	307
4111002	522	4126028	840	4160902	800	4171805	815	5010860	305	5012315	309	5013720	307
4121405	565	4126030	840	4161001	779	4171806	815	5010930	305	5012316	309	5013722	307
4121406	565	4126031	840	4161002	779	4171807	815	5010936	305	5012318	309	5013724	307
4121407	565	4126032	840	4161003	779	4171808	815	5010945	305	5012319	309	5013726	307
4122600	548	4126033	840	4161101	779	4171809	815	5010950	305	5012320	309	5013728	307
4122601	548	4126034	840	4161102	779	4171901	815	5010955	305	5012322	309	5013730	307
4122602	548	4126035	841	4161103	779	4171902	815	5010960	305	5012324	309	5013732	307
4122603	548	4126036	841	4161201	803	4171903	815	5010970	305	5012326	309	5013734	307
4122604	548	4126037	841	4161202	803	4171904	815	5011020	305	5012328	309	5013807	308
4122605	548	4126038	841	4161203	803	4172001	815	5011023	305	5012330	309	5013815	308
4122606	548	4126039	841	4161301	805	4172002	815	5011025	305	5012332	309	5013825	308
4122700	548	4126040	841	4161302	805	4172003	815	5011028	305	5012511	309	5013835	308
4122701	548	4126041	841	4161401	791	4172004	815	5011030	305	5012512	309	5013908	308
4122702	548	4126042	841	4161402	791	4172101	815	5011032	305	5012513	309	5013910	308
4122703	548	4126043	841	4161403	784, 791	4172102	815	5011035	305	5012514	309	5013911	308
4122704	548	4126044	841	4161404	791	4172201	815	5011040	305	5012515	309	5014020	305
4122800	554	4126045	841	4161405	791	4172301	816	5011230	306	5012516	309	5014022	305
4122801	554	4126101	842	4161406	791	4172302	816	5011333	306	5012517	309	5014025	305
4122802	554	4126102	842	4161407	791	4172401	816	5011420	306	5012518	309	5014028	305
4122803	554	4126103	842	4161408	785, 791	4172501	816	5011435	306	5012613	309, 381	5014030	305
4122900	555	4126104	842	4161409	791	4172502	816	5011510	307	5012614	381	5014032	305
4122901	555	4126105	842	4161410	791	5010015	304, 380	5011515	307	5012615	381	5014035	305
4123000	557	4126106	842	4161411	786, 791	5010016	304, 380	5011520	307	5012616	381	5014120	306
4123001	557	4126107	842	4161501	791	5010018	304, 380	5011528	307	5012900	310	5014125	306
4123100	553	4126108	842	4161502	791	5010019	304, 380	5011545	307	5013016	309	5014130	306
4123101	553	4126109	842	4161503	791	5010021	304, 380	5011618	307	5013018	309	5014135	306
4123102	553	4126110	842	4161504	791	5010022	304, 380	5011620	307	5013019	309	5014140	306
4123603	837	4126111	842	4161505	791	5010024	304, 380	5011622	307	5013020	309	5014145	306
4123605	837	4126112	842	4161506	791	5010027	304, 380	5011624	307	5013022	309	5014201	306
4124001	833	4126113	842	4161507	791	5010028	304, 380	5011626	307	5013024	309	5014202	306
4124002	833	4126114	842	4161508	791	5010030	304, 380	5011628	307	5013026	309	5014203	306
4124003	833	4126200	843	4161509	791	5010116	304	5011630	307	5013028	309	5014204	306
4124100	833	4126332	843	4161801	808	5010118	304	5011632	307	5013030	309	5014205	306
4124101	833	4126608	843	4161901	808	5010120	304	5011634	307	5013032	309	5014335	306
4124102	833	4130100	566	4161902	808	5010122	304	5011636	307	5013110	310	5014340	305
4124103	833	4130101	566	4162001	808	5010124	304	5011720	307	5013112	310	5020105	311
4124104	833	4130108	566	4162002	808	5010218	304, 380	5011733	307	5013113	310	5020106	311
4124200	833	4130112	566	4162003	808	5010221	304, 380	5011740	307	5013114	310	5020107	311
4124201	833	4130200	567	4162101	787	5010224	304, 380	5011745	307	5013115	310	5020108	311
4124202	833	4130201	567	4162102	787	5010313	304, 380	5011760	307	5013116	310	5020109	311
4124203	833	4130202	567	4162103	787	5010315	304, 380	5011830	308	5013117	310	5020110	311
4124301	834	4130300	567	4170100	812	5010316	304, 380	5011832	308	5013118	310	5020111	311
4124302	834	4130500	844	4170101	812	5010525	304	5011834	308	5013119	310	5020112	311
4124401	834	4130603	844	4170102	812	5010528	304	5011836	308	5013120	310	5020113	311
4124402	834	4130703	844	4170211	812	5010532	304	5011838	308	5013122	310	5020208	311
4124501	834	4130800	844	4170217	812	5010535	304	5011840	308	5013124	310	5020209	311
4124601	835	4140211	463	4170221	812	5010540	304	5011842	308	5013126	310	5020210	311
4124701	835	4140222	463	4170321	812	5010545	304	5011844	308	5013128	310	5020211	311
4124801	835	4140233	463	4170324	812	5010550	304	5011846	308	5013130	310	5020212	311
4125001	838	4140244	463	4170411	813	5010555	304	5011848	308	5013211	310	5020305	311
4125002	838	4140307	462	4170412	813	5010560	304	5011850	308	5013212	310	5020306	311
4125100	838	4140320	462	4170413	813	5010561	304	5011855	308	5013213	310	5020307	311
4125101	838	4160100	774	4170414	813	5010570	304	5011860	308	5013214	310	5020308	311
4126001	839	4160101	774	4170424	813	5010580	304	5011950	308	5013215	310	5020309	311
4126002	839	4160244	808	4170525	813	5010625	304	5011955	308	5013216	310	5020310	311
4126003	839	4160401	783	4170550	813	5010630	304	5011960	308	5013301	310	5020311	311
4126004	839	4160402	784	4170611	813	5010636	304	5011965	308	5013400	311	5020312	311
4126005	839	4160403	784	4170612	813	5010640	304	5011970	308	5013500	311	5020313	311
4126006	839	4160404	785	4170613	813	5010641	304	5011975	308	5013608	310	5020314	311
4126007	839	4160405	785	4170624	813	5010646	304	5011980	308	5013609	310	5020315	311
4126008	839	4160406	786	4170718	813	5010728	305	5011985	308	5013610	310	5020405	312
4126009	839	4160407	786	4170724	813	5010730	305	5012080	308	5013611	310	5020406	312
4126010	839	4160501	789	4170808	813	5010733	305	5012085	308	5013612	310	5020407	312
4126011	839	4160502	789	4170810	813	5010736	305	5012118	308	5013613	310	5020408	312
4126012	839	4160503	789	4170908	813	5010740	305	5012130	308	5013614	309, 310	5020409	312

CODE	PAGE	CODE	PAGE	CODE	PAGE	CODE	PAGE	CODE	PAGE	CODE	PAGE	CODE	PAGE
5020410	312	5022910	311	5031209	319	5041116	320	5062903	326	5092441	335	5101712	339, 761
5020411	312	5022911	311	5031609	318	5041118	320	5063101	327	5092625	335	5101723	339, 761
5020412	312	5022912	311	5031610	318	5050209	321	5063102	327	5092627	335	5101816	339, 761
5020413	312	5022914	311	5031611	318	5050211	321	5080116	328	5092630	335	5101915	340
5020414	312	5022916	311	5031838	317	5050214	321	5080118	328	5092725	335	5101918	340
5020508	312	5023008	312	5031840	317	5050217	321	5080119	328	5092727	335	5101921	340
5020509	312	5023009	312	5031842	317	5050220	321	5080120	328	5092801	335	5102015	340
5020510	312	5023010	312	5031846	317	5050224	321	5080122	328	5092802	335	5102018	340
5020511	312	5023011	312	5031850	317	5050227	321	5080123	328	5092803	335	5102021	340
5020512	312	5023012	312	5031910	317	5050307	321	5080214	331	5092900	335	5102113	340
5020609	312	5023013	312	5031912	317	5050309	321	5080301	331	5093011	335	5102115	340
5020610	312	5023110	312	5031914	317	5050311	321	5080302	331	5093012	335	5102118	340
5020611	312	5023111	312	5031916	317	5050313	321	5080401	331	5093013	335	5102121	340
5020612	312	5023112	312	5031918	317	5050315	321	5080402	331	5093023	335	5102126	340
5020809	312	5023207	313	5031920	317	5050317	321	5080503	331	5093118	336	5102130	340
5020810	312	5023208	313	5031922	317	5050401	322	5080504	331	5093120	336	5102213	340
5020811	312	5023209	313	5031924	317	5050506	322	5080603	331	5093122	336	5102215	340
5020812	312	5023210	313	5032009	318	5050507	322	5090115	332	5093218	336	5102218	340
5020960	313	5023211	313	5032010	318	5050508	322	5090215	332	5093220	336	5102226	340
5020965	313	5023212	313	5032011	318	5050510	322	5090306	332	5093222	336	5102230	340
5021020	314	5023310	313	5032110	318	5050512	322	5090418	332	5093400	336	5102315	340
5021024	314	5023311	313	5032112	318	5050601	322	5090424	332	5093500	336	5102318	340
5021026	314	5023312	313	5032114	318	5050714	322, 393	5090500	332	5093700	336	5102321	340
5021030	314	5023313	313	5032116	318	5050715	322, 393	5090604	332	5100105	337	5102323	340
5021107	314	5023507	313	5032118	318	5050813	322, 393	5090606	332	5100106	337	5102415	340
5021224	314	5023508	313	5032120	318	5050816	322, 393	5090609	332	5100108	337	5102418	340
5021400	315	5023509	313	5040109	320	5050817	322, 393	5090703	332	5100110	337	5102421	340
5021500	315	5023510	313	5040110	320	5050819	322, 393	5090816	333	5100112	337	5102423	340
5021604	315	5023511	313	5040111	320	5051010	321,	5090818	333	5100114	337	5102509	337
5021605	315	5023512	313	5040112	320		322, 393	5090820	333	5100165	337	5102609	337
5021606	315	5023608	313	5040113	320	5051012	321,	5090904	333	5100205	337	5102710	340
5021607	315	5023609	313	5040114	320		322, 393	5090905	333	5100206	337	5102810	340
5021608	315	5023610	313	5040116	320	5051015	322, 393	5090906	333	5100265	337	5103110	339
5021609	315	5023611	313	5040118	320	5051110	322, 393	5090907	333	5100305	337	5103210	339
5021610	315	5023612	313	5040201	320	5051112	322, 393	5090908	333	5100306	337	5110101	341
5021611	315	5023613	313	5040202	320	5051115	322, 393	5090909	333	5100365	337	5110108	341
5021612	315	5023708	313	5040203	320	5051209	322	5090910	333	5100405	337	5110208	341
5021701	315	5023709	313	5040204	320	5051212	322	5090912	333	5100406	337	5110324	341
5021702	315	5023710	313	5040205	320	5051215	322	5091006	333	5100408	337	5110413	341
5021703	315	5023845	316	5040206	320	5060101	326	5091007	333	5100410	337	5110507	341
5021801	315	5023860	316	5040207	320	5060102	326	5091008	333	5100412	337	5110607	199, 341
5021802	315	5023880	316	5040208	320	5060103	326	5091136	333	5100414	337	5110608	199, 341
5021803	315	5030117	317	5040301	320	5060301	325	5091216	333	5100465	337	5110709	342
5021810	315	5030118	317	5040302	320	5060302	325	5091220	333	5100505	337	5110710	342
5021811	315	5030217	317	5040303	320	5060303	325	5091322	333	5100506	337	5110711	342
5021901	316	5030412	317	5040304	320	5060501	323	5091324	333	5100565	337	5110712	342
5021902	316	5030414	317	5040305	320	5060502	323	5091326	333	5100605	338	5110714	342
5021903	316	5030416	317	5040306	320	5060503	323	5091422	333	5100606	338	5110800	342
5022032	316	5030418	317	5040401	320	5060601	323	5091424	333	5100665	338	5110925	342
5022048	316	5030420	317	5040402	320	5060602	323	5091426	333	5100705	338	5111001	342
5022111	316	5030422	317	5040403	320	5060603	323	5091515	333	5100706	338	5111104	342
5022112	316	5030514	317	5040404	320	5060701	323	5091543	333	5100765	338	5111108	342
5022113	316	5030516	317	5040501	320	5060702	323	5091600	334	5100805	338	5111110	342
5022114	316	5030518	317	5040502	320	5060907	324	5091709	334	5100806	338	5111111	342
5022204	316	5030520	317	5040503	320	5060908	324	5091710	334	5100865	338	5111115	342
5022206	316	5030528	318	5040621	321	5061201	323	5091712	334	5100905	338	5111145	342
5022208	316	5030604	318	5040622	321	5061301	324	5091713	334	5100906	338	5111155	342
5022210	316	5030605	318	5040713	321	5061302	324	5091714	334	5100907	338	5111165	342
5022212	316	5030814	318	5040715	321	5061303	324	5091715	334	5100908	338	5111213	342
5022214	316	5030816	318	5040716	321	5061601	324	5091716	334	5100910	338	5111215	342
5022216	316	5030820	318	5040718	321	5061602	324	5091718	334	5100912	338	5111218	342
5022330	316	5030822	318	5040722	321	5061801	325	5091720	334	5100914	338	5111313	342
5022360	316	5030824	318	5040814	321	5061802	325	5091808	334	5101005	338	5111315	342
5022380	316	5030826	318	5040816	321	5062001	323	5091809	334	5101006	338	5111318	342
5022406	316	5030910	318	5040818	321	5062002	323	5091810	334	5101007	338	5111404	343
5022408	316	5030912	318	5040928	321, 381	5062201	325	5091812	334	5101008	338	5111405	343
5022410	316	5030914	318	5040930	321, 381	5062202	325	5091814	334	5101010	338	5111500	343
5022412	316	5030916	318	5040933	321, 381	5062301	325	5091815	334	5101012	338	5111604	343
5022504	316	5030918	318	5040936	321, 381	5062302	325	5091816	334	5101014	338	5111605	343
5022506	316	5030920	318	5040939	321, 381	5062303	325	5091818	334	5101121	338	5111606	343
5022508	316	5030922	318	5040942	321, 381	5062501	326	5091820	334	5101221	339	5111607	343
5022510	316	5031010	318	5040945	321, 381	5062502	326	5091824	334	5101333	339	5111608	343
5022512	316	5031012	318	5040950	321, 381	5062503	326	5091915	334	5101433	339	5111610	343
5022609	314	5031015	318	5040960	321, 381	5062601	325	5092040	334	5101500	339	5111612	343
5022700	315	5031018	318	5041109	320	5062602	325	5092100	334	5101511	339, 761	5111613	343
5022808	314	5031020	318	5041110	320	5062701	326	5092200	334	5101512	339, 761	5111614	343
5022809	314	5031108	319	5041111	320	5062702	326	5092328	335	5101523	339, 761	5111615	343
5022810	314	5031109	319	5041112	320	5062703	326	5092332	335	5101616	339, 761	5111616	343
5022811	314	5031111	319	5041113	320	5062901	326	5092336	335	5101700	339	5111617	343
5022812	314	5031208	319	5041114	320	5062902	326	5092436	335	5101711	339, 761	5111618	343

CODE	PAGE	CODE	PAGE	CODE	PAGE	CODE	PAGE	CODE	PAGE	CODE	PAGE	CODE	PAGE
5111619	343	5120110	208	5131315	213	5160117	358	5162818	359	5171910	366, 464	5181310	375
5111620	343	5120111	209, 348	5131317	213	5160119	358	5162822	359	5172042	367, 500	5181366	375
5111621	343	5120112	208, 347	5131318	213	5160217	358	5162824	359	5172056	367, 500	5181399	375
5111645	343	5120113	205, 348	5131524	353	5160303	358	5162901	359	5172078	367, 500	5181515	375
5111701	343	5120114	205, 348	5131701	353	5160304	358	5163001	359	5172098	367, 500	5181516	375
5111703	343	5120115	208, 347	5131715	353	5160305	358	5163122	359	5172106	367, 501	5181517	375
5111707	343	5120200	348	5131910	354	5160401	359	5163125	359	5172210	367, 500	5181518	375
5111900	344	5120201	348	5131913	354	5160402	359	5163128	359	5172355	367, 500	5181519	375
5112000	344	5120203	348	5131915	354	5160403	359	5163224	359	5172455	367, 500	5181520	375
5112100	344	5120301	349	5132001	352	5160500	362,	5163226	359	5172500	367, 503	5181521	375
5112200	344	5120302	349	5132110	72, 354		379, 509	5163301	359	5172600	367, 503	5181522	375
5112320	75, 195,	5120303	349	5132113	72, 354	5160645	362	5163302	359	5172601	503	5181600	370
	344	5120304	349	5132120	72, 354	5160650	362	5163303	359	5172708	367, 502	5181700	370
5112324	75, 195,	5120305	349	5140100	354, 635	5160660	362	5163304	359	5172808	367, 502	5181800	370
	344	5120306	349	5140401	354, 635	5160670	362	5163415	360	5172940	367	5181806	370
5112327	75, 195,	5120307	349	5140501	355	5160680	362	5163515	360	5172945	367	5181900	370
	344	5120308	349	5140601	354	5160728	363	5163615	360	5172950	367	5190101	351
5112330	75, 195,	5120309	349	5141101	356	5160731	363	5163618	360	5173011	368, 478	5190102	351
	344	5120310	349	5141102	356	5160734	363	5163716	360	5173012	368, 478	5190103	351
5112333	75, 195,	5120311	349	5141103	356	5160738	363	5163718	360	5173034	368, 478	5190104	351
	344	5120312	350	5141104	356	5160905	362	5163720	360	5173110	368, 467	5190105	351
5112336	75, 195,	5120313	350	5141105	356	5160906	362	5163722	360	5173115	368, 467	5190106	351
	344	5120314	349	5141106	356	5160907	362	5163826	360	5173120	368, 467	5190107	351
5112339	75, 195,	5120315	350	5141107	356	5160908	362	5163918	360	5173205	368, 467	5190108	351
	344	5120316	350	5141108	356	5160909	362	5164001	360	5173408	368, 467	5190109	351
5112342	75, 195,	5120317	350	5141201	356	5160910	362	5164215	361	5173525	368, 466	5190110	351
	344	5120318	350	5141202	356	5160945	362	5164217	361	5173525A	466	5190111	351
5112409	345	5120319	349	5141203	356	5160955	362	5164219	361	5173622	369, 476	5190112	351
5112410	345	5120320	351	5141204	356	5161105	363	5164314	361	5173625	369, 476	5190113	351
5112412	345	5120321	350	5141205	356	5161106	363	5164316	361	5173630	369, 476	5190114	351
5112414	345	5120322	350	5141206	356	5161107	363	5164318	361	5173800	369, 475	5190115	351
5112415	345	5120323	351	5141207	356	5161108	363	5164415	361	5173900	369, 474	5190116	351
5112520	345	5120324	349	5141301	356	5161109	363	5164416	361	5180100	370	5190117	351
5112523	345	5120325	350	5141302	356	5161205	363	5164418	361	5180200	370	5190118	351
5112525	345	5120326	350	5141303	356	5161206	363	5164419	361	5180307	375	5190119	351
5112530	345	5120327	350	5141304	356	5161207	363	5164510	361	5180431	371, 577	5190120	351
5112535	345	5120328	350	5141305	356	5161300	363	5164512	361	5180432	371, 577	5190201	351
5112538	345	5120329	349	5141306	356	5161405	363	5164514	361	5180433	371, 577	5190202	351
5112601	345	5120330	349	5141401	356	5161406	363	5164516	361	5180434	371, 577	5190203	351
5112602	345	5120331	349	5141402	356	5161407	363	5164612	362	5180435	371, 577	5190204	351
5112701	345	5120332	350	5141403	356	5161408	363	5164715	362, 378	5180436	371, 577	5190205	351
5112702	345	5120333	350	5141404	356	5161409	363	5164720	378	5180437	371, 577	5190206	351
5112925	72, 345	5120334	350	5141405	356	5161505	363	5170200	364	5180438	371, 577	5190301	351
5112928	72, 345	5120335	349	5141406	356	5161506	363	5170400	364	5180439	371, 577	5190302	351
5112931	72, 345	5120336	350	5141407	356	5161507	363	5170502	364	5180440	577	5190303	351
5113003	345	5120337	351	5141501	356	5161508	363	5170503	364	5180441	577	5190304	351
5113004	345	5120338	351	5141502	356	5161509	363	5170603	364	5180442	577	5190305	351
5113005	345	5120339	351	5141503	356	5161605	361	5170704	364, 482	5180443	577	5190306	351
5113101	345	5120340	351	5141504	356	5161606	361	5170706	364, 482	5180444	577	5190401	351
5113201	346	5122221	340	5141505	356	5161607	361	5170902	364, 482	5180445	577	5190402	351
5113301	346	5130130	352	5141506	356	5161608	361	5170903	364, 482	5180446	577	5190403	351
5113302	346	5130230	352	5141507	356	5161609	361	5171001	365	5180540	371	5190404	351
5113303	346	5130428	352	5141601	356	5161655	361	5171002	365	5180541	371	5190405	351
5113401	346	5130440	352	5141602	356	5161705	361	5171112	365	5180542	371	6010114	31, 182
5113402	346	5130640	352	5141603	356	5161706	361	5171113	365	5180543	371	6010116	31, 182
5113518	346	5130775	352	5141604	356	5161707	361	5171123	365	5180544	371	6010118	31, 182
5113519	346	5130830	352	5141605	356	5161708	361	5171211	365, 485	5180545	371	6010120	31, 182
5113618	346	5131030	352	5141606	356	5161709	361	5171216	365, 485	5180546	371	6010124	31, 182
5113701	342, 346	5131104	353	5141607	356	5161720	362	5171218	365, 485	5180701	372	6010220	31, 182
5113703	346	5131106	353	5150106	357	5161755	361	5171220	365, 485	5180702	372	6010224	31, 182
5113704	346	5131108	353	5150112	357	5161817	361	5171222	365, 485	5180704	372	6010228	31, 182
5113710	346	5131200	213, 353	5150115	357	5161819	361	5171224	365, 485	5180708	372	6010230	31, 182
5113716	346	5131204	213, 353	5150316	357	5161900	363	5171321	365, 485	5180710	578	6010316	32, 182
5113718	346	5131206	213, 353	5150318	357	5161901	363	5171403	365	5180712	578	6010320	32, 182
5113720	346	5131207	213, 353	5150320	357	5161910	363	5171404	365	5180713	372	6010324	32, 182
5113801	343, 346	5131208	213, 353	5150322	357	5161920	363	5171506	366, 463	5180714	578	6010328	32, 182
5113802	346	5131210	213, 353	5150401	357, 394	5161930	363	5171508	366, 463	5180716	578	6010409	33, 183
5113803	346	5131212	213, 353	5150402	357, 394	5162306	363	5171510	366, 463	5180901	372	6010510	33, 183
5113804	346	5131213	213, 353	5150403	357, 394	5162307	363	5171615	366, 463	5180902	372	6010512	33, 183
5113906	343	5131215	213, 353	5150404	357,	5162308	363	5171620	366, 463	5180903	372	6010514	33, 183
5113907	343	5131217	213, 353		393, 394	5162309	363	5171630	366, 463	5180904	372	6010516	33, 183
5114012	346	5131218	213, 353	5150801	358	5162310	363	5171640	366, 463	5180905	372	6010518	33, 183
5114014	346	5131300	213	5150802	358	5162401	361, 378	5171715	366, 464	5180906	372	6010520	33, 183
5114016	346	5131304	213, 353	5150901	358	5162402	361, 378	5171720	366, 464	5180907	372	6010624	34, 183
5114018	346	5131306	213, 353	5151101	357	5162403	361, 378	5171730	366, 464	5180908	372	6010628	34, 183
5120101	208, 347	5131307	213, 353	5151102	357	5162515	358	5171740	366, 464	5180909	372	6010710	34, 183
5120106	209, 348	5131308	213, 353	5151218	357	5162520	358	5171806	366, 464	5181304	375	6010716	34, 183
5120107	209, 348	5131309	353	5151225	357	5162613	358	5171808	366, 464	5181305	375	6010720	34, 183
5120108	208, 347	5131310	213	5151251	357	5162616	358	5171906	366, 464	5181306	375	6010724	34, 183
5120109	209, 348	5131312	213	5151301	358	5162701	359	5171908	366, 464	5181308	375	6010820	34, 183

CODE	PAGE	CODE	PAGE	CODE	PAGE	CODE	PAGE	CODE	PAGE	CODE	PAGE	CODE	PAGE
6010824	34, 183	6030905	197	6070320	81, 192	6093501	218	6110900	227, 575	6113312	237	6120508	239
6010828	34, 183	6030910	197	6070323	81, 192	6093812	212	6111000	233	6113314	237	6120509	239
6010932	34, 183	6031101	191	6070327	81, 192	6093901	214	6111106	233	6113712	231	6120510	239
6010936	34, 184	6040101	193	6070330	81, 192	6093902	214	6111109	233	6113720	231	6120511	239
6011112	35, 184	6040201	193	6070335	81, 192	6093903	214	6111110	233	6113844	238	6120512	239
6011114	35, 184	6040301	193	6070415	81, 192	6094001	214	6111112	233	6113846	238	6120660	239
6011116	35, 184	6040302	193	6070421	81, 192	6100110	219	6111200	233	6113848	238	6120701	240
6011118	35, 184	6050101	200	6070427	81, 192	6100112	219	6111201	233	6113903	227, 576	6120703	240
6011120	35, 184	6050201	200	6070530	81, 192	6100113	219	6111300	233	6114000	227, 576	6120705	240
6011124	35, 184	6050301	200	6070535	81, 192	6100114	219	6111400	234	6114109	233	6120707	240
6011128	35, 184	6050401	200	6070613	192	6100115	219	6111500	234	6114110	233	6120901	240
6011230	185	6050501	200, 352	6070713	79, 192	6100201	219	6111604	234	6114112	233	6120902	240
6011311	185	6050613	200	6070801	200	6100311	219	6111605	234	6114220	233	6121001	240
6011409	185	6050615	200	6070901	200	6100313	219	6111730	229	6114225	233	6121002	240
6011516	185	6050618	200	6071001	191	6100317	219	6111740	229	6114226	233	6121101	241
6011520	185	6050801	201	6071103	195	6100399	219	6111750	229	6114320	229	6121103	241
6011612	35, 185	6050901	201	6071212	75, 195	6100409	220	6111825	229	6114325	229	6121105	241
6011613	35, 185	6051001	211	6071218	75, 195	6100410	220	6111827	229	6114330	229	6121107	241
6011614	35	6051101	211	6071224	75, 195	6100411	220	6111829	229	6114400	230	6121108	241
6011716	31, 182	6051203	211	6071240	195	6100412	220	6111925	231	6114595	229	6121109	241
6011717	187	6051204	211	6071314	195	6100414	220	6111930	231	6114596	229	6121201	241
6011720	31, 182	6051205	211	6071340	195	6100520	220	6111935	231	6114600	234	6121202	241
6011723	187	6051301	211	6071350	195	6100524	220	6111940	231	6114601	234	6121204	241
6011724	31, 182	6051401	211	6080121	196	6100526	220	6112025	231	6114740	230	6121206	241
6011727	187	6051501	211	6080237	196	6100528	220	6112027	231	6114750	230	6121208	241
6011732	187	6051502	211	6080301	112, 196	6100532	220	6112029	231	6114818	231	6121210	241
6011736	187	6051503	211	6080401	112, 196	6100624	220	6112150	230	6114820	231	6121211	241
6011740	187	6051504	211	6080601	196	6100628	220	6112160	230	6114822	231	6121301	241
6011816	186	6051505	211	6080602	196	6100632	220	6112200	228	6114940	231	6121302	241
6011820	31, 182,	6051600	200	6090124	212	6100709	220	6112250	228	6114950	231	6121304	241
	186	6051700	200	6090212	212	6100710	220	6112350	228	6115030	228	6121306	241
6011824	31, 182	6051800	201	6090312	212	6100712	220	6112360	228	6115040	228	6121308	241
6011825	186	6051900	201	6090420	212	6100713	220	6112435	230	6115050	228	6121401	241
6011827	186	6052000	201	6090524	212	6100714	220	6112450	230	6115060	228	6121403	241
6011829	186	6052100	201	6090660	212	6101100	222	6112525	228	6115235	228	6121405	241
6011833	186	6060105	199	6090701	213	6101200	222	6112530	228	6115301	229	6121407	241
6011839	186	6060107	199	6090801	213	6101300	222	6112535	228	6115401	229	6121419	241
6011917	187	6060205	199	6090980	214	6101500	222	6112540	228	6115525	228	6121501	241
6011920	32, 182	6060206	199	6091101	214	6101600	222	6112630	231	6115530	228	6121502	241
6011922	187	6060207	199	6091201	214	6102040	67, 223	6112635	231	6115535	228	6121503	241
6011924	32, 182	6060501	198	6091301	214	6102053	67, 223	6112640	231	6115540	228	6121601	241
6011926	187	6060601	198	6091302	214	6102060	67, 223	6112750	230	6115608	236	6121602	241
6011928	32, 182	6060701	198	6091303	214	6102065	67, 223	6112925	231	6115610	236	6121603	241
6011930	187	6060856	198	6091401	214	6102815	224	6112930	231	6115612	236	6121604	241
6012017	187	6060857	198	6091402	214	6102914	224	6112935	231	6115708	237	6121606	241
6012020	187	6060901	201	6091403	214	6103103	224	6112940	231	6115710	237	6121701	241
6012023	187	6060902	201	6091501	214	6103304	224	6112970	234	6115712	237	6121702	241
6012026	187	6061001	201	6091616	215	6103305	224	6112971	234	6115830	230	6121703	241
6012112	34, 184	6061101	199	6091618	215	6103405	224	6112972	234	6115840	230	6121801	240, 241
6012116	34, 184	6061201	199	6091750	215	6103406	224	6112973	234	6115850	230	6121802	241
6012120	34, 184	6061301	202	6091755	215	6103600	225	6113004	237	6115860	230	6121803	240, 241
6012124	34, 184	6061401	202	6091825	215, 353	6103601	225	6113005	237	6120104	240	6121804	241
6012216	33, 184	6061402	202	6091828	215, 353	6103602	225	6113006	237	6120105	240	6121805	240
6012220	33, 184	6061501	202	6091834	215, 353	6103603	225	6113007	237	6120110	347	6121807	240
6012224	33, 184	6061502	202	6091840	215, 353	6103701	225	6113008	237	6120203	240	6121901	241
6012313	33, 184	6061506	202	6091846	215, 353	6103702	225	6113009	237	6120204	240	6121903	241
6012420	31	6061507	202	6091850	353	6103703	225	6113010	237	6120205	240	6122001	241
6012516	32	6061508	202	6091855	353	6103704	225	6113012	237	6120306	240	6122003	241
6020101	189	6061606	202	6091865	353	6103800	225	6113014	237	6120307	240	6122005	241
6020540	194	6061608	202	6091870	353	6103900	225	6113106	236	6120308	240	6122006	241
6020545	194	6061701	189	6091901	215, 353	6110112	225	6113107	236	6120310	240	6122102	241
6020601	191	6061801	189	6092001	215	6110124	225	6113108	236	6120312	240	6122104	241
6020702	191	6061901	189	6092101	215	6110212	225	6113109	236	6120314	240	6122106	241
6020703	191	6062001	189	6092201	216	6110224	225	6113110	236	6120316	240	6122107	241
6020704	191	6062101	189	6092301	216	6110400	226	6113112	236	6120318	240	6122210	232
6020705	191	6062201	190	6092401	217	6110401	226	6113114	236	6120320	240	6122212	232
6020706	191	6062301	190	6092402	217	6110402	226	6113206	236	6120406	240	6122214	232
6020803	92, 191	6062401	190	6092501	217	6110403	226	6113207	236	6120407	240	6122216	232
6020804	92, 191	6062501	190	6092502	217	6110404	226	6113208	236	6120409	240	6122218	232
6020901	189	6062601	190	6092622	217	6110405	226	6113209	236	6120412	240	6122220	232
6021022	194	6062701	190	6092633	217	6110500	226	6113210	236	6120415	240	6122222	232
6021023	194	6062801	190	6092708	217	6110501	226	6113212	236	6120417	240	6122224	232
6021024	194	6062901	191	6092808	217	6110502	226	6113214	236	6120419	240	6122226	232
6021025	194	6063039	199	6093113	218	6110620	226	6113304	237	6120501	239	6122228	232
6021026	194	6063100	189	6093117	218	6110624	226	6113305	237	6120502	239	6122230	232
6021027	194	6063200	190	6093213	218	6110627	226	6113306	237	6120503	239	6122312	232
6022610	314	6063300	191	6093217	218	6110628	226	6113307	237	6120504	239	6122314	232
6022611	314	6070213	79, 192	6093315	218	6110703	227, 576	6113308	237	6120505	239	6122316	232
6022612	314	6070315	81, 192	6093415	218	6110706	227, 576	6113309	237	6120506	239	6122318	232
6030902	197	6070318	81, 192	6093424	218	6110800	227, 576	6113310	237	6120507	239	6122320	232

CODE	PAGE	CODE	PAGE	CODE	PAGE	CODE	PAGE	CODE	PAGE	CODE	PAGE	CODE	PAGE
6122322	232	6164407	242	6173301	250	6181902	258	6213400	203	6273101	298	7030430	678
6122324	232	6164506	242	6173401	250	6182002	260	6213401	203	6273201	299	7030524	679
6122326	232	6164507	242	6173501	250	6182003	260	6250101	291	6273301	299	7030526	678
6122328	232	6164606	242	6173601	250	6182101	260	6250201	291	6273401	299	7030601	679
6122330	232	6164607	242	6173701	250	6200107	206	6250301	291	6273501	299	7030721	679
6122416	232	6164800	242	6173801	250	6200209	206	6250801	291	6273601	299	7030725	679
6122418	232	6164900	242	6173901	250	6200309	206	6250901	291	6273701	299	7030821	675
6122420	232	6165000	243	6174001	250	6200409	206	6251001	291	6273801	299	7030902	679
6122422	232	6165110	243	6174002	250	6200509	206	6251101	292	6273901	299	7030903	679
6122424	232	6165112	243	6174101	251	6200609	206	6251204	292	6274001	299	7031101	687
6122426	232	6165200	243	6174102	251	6200707	206	6251205	292	6274101	300	7031225	674
6122428	232	6165500	243	6174201	251	6200807	206	6251206	292	6274201	300	7031328	674
6122430	232	6165601	243	6174202	251	6200908	206	6251401	292	6274301	300	7031401	675
6122520	232	6165602	243	6174203	251	6201008	206	6251501	292	6274401	300	7031415	674
6122524	232	6165603	243	6174204	251	6201105	206	6251601	292	6274501	300	7031965	674
6122526	232	6165700	243	6174205	251	6201205	206	6251701	292	6274601	300	7040101	671
6122528	232	6165901	243	6174206	251	6201307	206	6251801	295	6274701	300	7040201	671
6122620	232	6165902	243	6174207	251	6201407	206	6251901	295	6274702	300	7040401	680
6122622	232	6166001	243	6174208	251	6201507	207	6251902	295	6274814	301	7040901	681
6122624	232	6166101	243	6174209	251	6201607	207	6252001	295	6274819	301	7041001	681
6122716	232	6166200	237	6174210	251	6201707	207	6252002	295	6274826	301	7041101	681
6122720	232	6166300	237	6174211	251	6201807	207	6252003	295	6274920	301	7041201	681
6122724	232	6166400	238	6174212	251	6201908	207	6252004	295	6275013	301	7041301	681
6122816	232	6166600	237	6174213	251	6202008	207	6252112	292	6275112	301	7041601	671
6122820	232	6166601	237	6174214	251	6202108	207	6252120	292	6275212	302	7041715	671
6122822	232	6166818	238	6174301	252	6202207	207	6252235	292	6275225	302	7041730	671
6122901	241	6166822	238	6174401	252	6202307	207	6252300	295	6275314	302	7042001	680
6122902	241	6170101	245	6174402	252	6202408	207	6253100	296	6275319	302	7042101	671
6123016	235	6170201	245	6174403	252	6202508	207	6253200	296	6275418	302	7050103	683
6123020	235	6170202	245	6174404	252	6202615	205	6253310	296	6275517	302	7050104	683
6123024	235	6170301	245	6174405	252	6202726	205	6253315	296	6275526	302	7050105	683
6123116	235	6170302	245	6174406	252	6202908	208, 347	6253401	293	6275601	301	7050106	683
6123120	235	6170401	245	6174407	252	6203009	208, 347	6253424	293	6275602	301	7050401	683
6123124	235	6170501	245	6174408	252	6203014	208, 347	6253507	294	6275712	302	7050402	683
6123206	236	6170502	245	6174409	252	6203209	208, 347	6253614	294	6275716	302	7050601	683
6123207	236	6170601	245	6174501	253	6203309	208, 347	6260600	111	6275810	302	7050801	683
6123208	236	6170701	246	6174502	253	6203706	208, 347	6261601	107	6292618	217	7051009	684
6123209	236	6170801	246, 257	6174503	253	6203806	208, 347	6261602	107	7010101	676	7051110	684
6123210	236	6170901	246	6175001	253	6203908	208, 347	6261603	107	7010301	676	7051225	684
6123211	236	6170902	246	6175101	253	6210101	204	6261604	107	7010501	676	7051240	684
6123212	236	6171001	246	6175201	253	6210102	204	6261605	107	7010601	676	7051324	684
6123306	236	6171002	246	6175301	254	6210103	204	6261701	108	7010701	675, 676	7051401	684
6123307	236	6171101	246	6175401	254	6210104	204	6261801	108	7010702	675	7051713	683
6123308	236	6171201	246	6175402	254	6210105	204	6261802	108	7010801	676	7060105	672
6123309	236	6171301	246	6175501	254	6210106	204	6261803	108	7010901	676	7060110	672
6123406	236	6171302	246	6175502	254	6210107	204	6261901	108	7011201	676	7060120	672
6123407	236	6171303	246	6175601	254	6210108	204	6261902	108	7011301	676	7060305	686
6123408	236	6171401	247	6180101	255	6210116	204	6270101	297	7011514	675	7060310	686
6123409	236	6171402	247	6180102	255	6210250	204	6270201	297	7020101	677	7060325	686
6123410	236	6171403	247	6180103	255	6210251	204	6270202	300	7020201	677	7060521	685
6123412	236	6171404	247	6180105	255	6210305	204	6270301	297	7020202	677	7060531	685
6123510	235	6171405	247	6180106	256	6210307	204	6270401	297	7020301	677	7060541	685
6123516	235	6171406	247	6180201	256	6210401	205	6270501	297	7020302	677	7060610	685
6123520	235	6171501	247	6180202	256	6210501	205	6270601	297	7020303	677	7060616	685
6123524	235	6171502	247	6180203	256	6210601	204	6270701	297	7020428	677	7060624	685
6123616	235	6171601	247	6180302	256	6210701	204	6270801	297	7020448	677	7060905	672
6123620	235	6171602	247	6180303	256	6210901	203, 341	6270901	297	7020501	677	7060910	672
6123721	235	6171603	247	6180401	256	6211001	203	6271001	299	7020502	677	7060920	672
6123725	235	6171701	247	6180402	256	6211101	203	6271003	301	7020503	677	7061016	686
6151307	292	6171801	247	6180403	256	6211310	210	6271003	301	7020608	677	7061032	686
6163624	235	6171802	247	6180501	256	6211411	210	6271101	299	7020610	677	7061064	686
6163907	242	6171901	248	6180502	257	6211511	210	6271201	299	7020611	677	7061105	686
6164010	243	6172001	248	6180601	257	6211611	210	6271301	300	7020716	677	7061110	686
6164012	243	6172101	248	6180701	257	6211711	210	6271401	300	7020717	677	7061125	686
6164101	360	6172102	248	6180901	258	6211811	210	6271501	297	7020718	677	7070201	687
6164104	242	6172201	248	6181001	258	6211911	210	6271601	297	7020801	678	7070301	687
6164105	242	6172301	248	6181101	258	6212011	210	6271701	297	7020901	678	7070401	687
6164106	242	6172401	248	6181102	258	6212111	210	6271801	297	7021101	674	7070501	687
6164108	242	6172501	248	6181201	259	6212211	210	6271901	298	7021201	678	7070502	687
6164221	242	6172502	248	6181301	259	6212411	210	6272001	298	7021330	677	7070508	817
6164222	242	6172601	249	6181401	259	6212506	210	6272101	298	7021340	677	7070601	687
6164223	242	6172701	249	6181501	259	6212609	210	6272201	298	7021350	677	7070701	687
6164224	242	6172703	249	6181502	259	6212712	210	6272301	298	7021613	674	7070801	687
6164225	242	6172703	249	6181601	257	6212806	210	6272401	298	7021614	674	7080112	687
6164226	242	6172801	249	6181701	257	6212903	210	6272501	298	7021615	674	7080118	687
6164309	242	6172802	249	6181702	257	6213012	210	6272601	298	7021748	674	7080124	687
6164310	242	6172901	249	6181703	257	6213142	210	6272701	298	7021800	674	7080136	687
6164311	242	6173001	249	6181704	257	6213212	203	6272801	298	7030101	678	7090401	688
6164405	242	6173101	249	6181801	257	6213300	203	6272901	298	7030201	678	7090512	688
6164406	242	6173201	249	6181901	258	6213301	203	6273001	298	7030301	674	7090514	688

CODE	PAGE	CODE	PAGE	CODE	PAGE	CODE	PAGE	CODE	PAGE	CODE	PAGE	CODE	PAGE
7090706	187, 688	7131101	696	7192507	706	8020619	433	8061400	459	8101801	478	8161233	499
7090708	187, 688	7131201	697	7192609	706	8020624	433	8061401	459	8101825	478	8161910	498
7090710	187, 688	7131301	697	7192710	706	8020700	434	8070101	464	8101906	477	8162000	497
7090712	187, 688	7131401	697	7192817	706	8020800	435	8070210	465	8101912	478	8170142	500
7090714	187, 688	7131501	697	7193008	706	8021000	436	8070235	465	8110180	481	8170172	500
7090809	187, 688	7131721	675	7193109	706	8021100	437	8070255	465	8110205	481	8170254	500
7090811	187, 688	7131821	675	7193214	706	8021310	437	8070301	465	8110305	481	8170300	502
7090814	187, 688	7140101	698	7193313	706	8021320	437	8070302	465	8110310	481	8170301	502
7091001	688	7140201	698	7193409	706	8021410	438	8070463	465	8110402	481	8170400	501
7091002	688	7140301	699	7193510	706	8021500	438	8080130	368, 466	8120304	482	8170527	501
7100101	689	7140401	699	7193612	706	8021501	438	8080130A	466	8120411	483	8170627	501
7100201	689	7140402	699	7193716	706	8021502	438	8080134A	368	8120412	483	8170739	502
7100202	689	7141015	700	7200108	707	8021600	435	8080160A	466	8120643	483	8170757	502
7100203	689	7141017	700	7200212	707	8021800	437	8080280A	466	8120646	483	8170808	501
7100204	689	7141101	700	7200312	707	8021904	436	8080310	468	8120743	483	8170901	499
7100301	689	7141217	700	7200414	707	8021906	436	8080320	468	8120746	483	8170902	499
7100401	689	7141222	700	7200515	707	8022001	430	8080330	468	8120802	483	8171025	503
7100402	689	7141501	699	7200615	707	8030148	443, 710	8080400	468	8120961	484	8171050	503
7100501	689	7141612	699	7200714	707	8030202	442	8080500	468	8120962	484	8180101	505
7100502	689	7141712	699	7200814	707	8030203	442	8080600	468	8121061	484	8180102	506
7100605	689	7141812	699	7200914	707	8030300	444, 711	8080710	469	8121062	484	8180300	508
7100606	689	7141912	699	7201012	707	8030400	445, 711	8080720	469	8121106	484	8180402	504
7100607	689	7142017	700	7201114	707	8030500	445	8080730	469	8121108	484	8180501	506
7100705	689	7142126	700	7201212	707	8030600	445	8080731	469	8121110	484	8180700	508
7100706	689	7142220	700	7201301	707	8030700	444	8080740	469	8121204	484	8180800	509
7100707	689	7150101	524, 710	7201412	707	8030800	443	8080801	469	8121206	484	8180801	509
7101027	690	7150201	439, 708	7201613	707	8030905	444	8090200	470	8121208	484	8180901	508
7110101	355, 694	7150301	439, 708	8010101	406	8031100	439	8090315	470	8121210	484	8180902	508
7110201	694	7150401	440, 708	8010103	406	8031101	441	8090400	472	8121300	485	8180903	508
7110301	403, 694	7150501	440, 708	8010104	407	8031102	441	8090401	472	8122100	486	8180904	508
7110702	517	7150601	440	8010105	409	8031200	442	8090402	472	8122102	486	8181030	507
7110703	517	7150701	440, 709	8010106	407	8031201	440	8090510	472	8122200	486, 487	8181035	507
7120260	691	7150702	709	8010107	409	8031300	445	8090622	471	8122202	486, 487	8181130	507
7120360	691	7150801	441, 709	8010108	408	8031400	446	8090801	471	8122203	487	8181135	507
7120464	691	7150901	435	8010201	411	8031500	448	8090802	471	8122700	488	8181228	507
7120634	691	7151001	441	8010202	411	8040132	449	8090803	471	8122701	488	8181330	507
7120760	691	7151101	441	8010203	412	8040277	449	8090804	471	8122702	488	8181336	507
7120802	692	7151201	443	8010204	414	8040318	449	8090805	471	8122801	487	8190110	510
7120805	692	7151301	443, 709	8010205	415	8040403	450	8090900	473	8122802	487	8190110	510
7120810	692	7151302	709	8010206	410	8040507	450	8090901	473	8122900	488	8190205	510
7120815	692	7151401	710	8010207	410	8040601	451	8091112	473	8122902	488	8190205	510
7121104	484	7151701	446, 711	8010208	412	8040602	451	8091114	473	8123000	486	8190300	510
7121440	691	7151702	446, 711	8010209	413	8040622	450	8091125	473	8130100	489	8190610	510
7121450	691	7151801	447, 712	8010210	414	8040724	451	8091200	470	8130200	489	8190710	510
7121460	691	7151901	447, 712	8010211	415	8040900	452, 711	8091300	471	8130201	489	8190830	510
7121500	691	7152001	447, 449	8010212	415	8041001	451	8091301	471	8130202	489	8190930	510
7121901	692	7152001	449, 712	8010301	416	8041100	450	8091302	471	8130203	490	8191040	510
7121971	692	7152101	439, 708	8010302	416	8051400	453	8091303	471	8130300	490	8191140	510
7121981	692	7152102	439, 708	8010304	417	8051401	453	8091400	470	8130301	490	8191250	510
7122060	692	7152201	710	8010305	419	8051500	453	8100100	474	8130302	490	8191350	510
7122070	692	7160601	682	8010306	416	8051501	453	8100101	474	8130303	490	8200115	511
7122159	692	7160701	682	8010307	417	8051502	453	8100212	476	8130400	490	8200140	511
7122169	692	7160801	682	8010308	419	8051503	453	8100222	476	8130401	490	8200180	511
7122179	692	7160901	682	8010309	420	8051504	453	8100320	477	8140405	492	8200501	513
7122303	693	7161001	682	8010401	422	8051505	453	8100330	477	8140407	492	8200502	513
7122306	693	7170104	698	8010402	422	8051506	453	8100345	477	8140409	492	8200600	512
7122312	693	7190112	705	8010403	422	8051507	453	8100360	477	8140704	492	8200700	512
7122434	693	7190213	705	8010405	423	8051508	453	8100380	477	8140800	491	8201014	514
7122457	693	7190309	705	8010406	423	8051509	453	8100420	477	8140801	491	8201150	514
7122532	693	7190411	705	8010407	423	8051800	452	8100430	477	8140901	491	8201160	514
7122620	693	7190510	705	8010408	422	8060100	458	8100445	477	8141001	491	8201300	513
7122655	693	7190612	705	8010409	423	8060101	458	8100460	477	8141002	491	8201400	512
7122670	693	7190710	705	8010410	424	8060200	459	8100480	477	8141003	491	8201401	512
7122712	693	7190813	705	8010411	424	8060602	462	8100512	477	8150105	492	8201500	513
7122812	693	7190913	705	8010412	425	8060603	462	8100522	477	8150110	492	8201601	514
7122824	693	7191011	705	8010413	425	8060802	462	8100608	478	8150240	493	8201602	514
7130201	695	7191109	705	8010700	406	8060803	462	8100612	477	8150280	493	8201701	515
7130401	695	7191212	705	8020103	431	8060930	461	8100700	479	8150506	496	8201701-1	515
7130402	695	7191321	705	8020105	431	8060940	461	8100701	479	8150513	496	8201801	515
7130403	699	7191419	705	8020203	433	8060941	461	8100708	477	8150601	495	8201802	515
7130404	695	7191509	705	8020305	432	8060950	461	8100910	480	8150602	495	8211218	516
7130405	695	7191603	706	8020310	432	8061025	461	8100913	480	8150603	495	8211224	516
7130516	695	7191714	706	8020320	432	8061121	458	8101025	475	8160100	496	8211230	516
7130517	695	7191816	706	8020330	432	8061123	458	8101030	475	8160101	496	8211236	516
7130601	696	7191912	706	8020350	432	8061215	461	8101100	476	8160102	496	8211248	516
7130701	696	7192009	706	8020405	434	8061220	461	8101200	479	8160601	497	8220116	169, 523
7130801	696	7192107	706	8020410	434	8061230	461	8101400	477	8160602	497	8220124	169, 523
7130802	696	7192215	706	8020516	431	8061231	461	8101600	177, 480	8161014	498	8220213	523
7130901	696	7192311	706	8020519	431	8061235	461	8101700	479	8161018	498	8220220	523
7131001	696	7192413	706	8020524	431	8061300	459	8101800	475	8161223	499	8220245	523

CODE	PAGE	CODE	PAGE	CODE	PAGE	CODE	PAGE	CODE	PAGE	CODE	PAGE	CODE	PAGE
8220320	523	9010923	573	9016927	575	9050120	627, 629	9061116	620	9111003	638	9120812	641
8220345	523	9011009	573	9017032	575	9050125	626, 629	9061125	620	9111004	638	9130530	642
8220400	524	9011015	573	9021911	316	9050136	626, 629	9061136	620	9111301	639	9130540	642
8220500	524	9011023	573	9030101	603	9050149	626, 629	9061149	620	9111301	639	9130601	642
8220609	524	9011030	573	9030201	603	9050209	630	9061216	621	9111302	639	9130701	642
8220700	525	9011038	573	9030301	601	9050216	630	9061225	621	9111302	639	9130901	643
8220701	525	9011101	573	9030302	601	9050220	630	9061236	621	9111303	639	9130902	643
8230118	560	9011102	573	9030401	601	9050225	630	9061316	621	9111303	639	9130903	643
8230136	560	9011201	573	9030402	601	9050236	630	9061325	621	9111401	639	9131001	643
8230215	560	9011202	573	9030501	600	9050249	630	9061336	621	9111402	639	9131002	643
8230310	561	9011309	574	9030502	600	9050316	631	9061408	621	9111403	639	9131003	643
8230320	561	9011315	574	9030503	600	9050320	631	9061410	621	9111501	639	9131101	643
8230330	561	9011323	574	9030504	600	9050325	631	9061417	621	9111701	639	9131201	644
8230401	561	9011409	574	9030505	600	9050336	631	9061508	621	9111801	639	9131202	644
8230402	561	9011415	574	9030510	602	9050401	630	9061510	621	9111803	639	9131301	644
8240100	563	9011423	574	9030512	602	9050501	628	9061517	621	9120103	640	9131302	644
8240200	562	9011430	574	9030513	602	9050601	628	9061600	622	9120104	640	9131303	644
8240300	563	9011438	574	9030514	602	9050701	628	9061700	621	9120105	640	9131401	643
8240401	562	9011501	574	9030601	602	9050801	628	9061901	618	9120106	640	9131402	643
8240402	562	9011502	574	9030701	602	9050901	628	9061902	618	9120107	640	9131403	643
8250101	454	9011601	574	9030801	602, 603	9051101	628	9061903	618	9120108	640	9131501	643
8250102	454	9011602	574	9030802	603	9051201	631	9070137	603	9120109	640	9131502	643
8250201	454	9011701	574	9030901	604	9051301	631	9070142	603	9120110	640	9131503	643
8250202	454	9011702	574	9030902	604	9051401	626	9070147	603	9120111	640	9131701	644
8250301	455	9011801	574	9030903	604	9051402	626	9070152	603	9120112	640	9131702	644
8250302	455	9011921	227, 575	9031001	603	9051403	626	9070156	603	9120205	640	9131703	644
8250303	455	9011927	227, 575	9031002	603	9051404	626	9070162	603	9120206	640	9131901	644
8250401	456	9011937	227, 575	9031003	603	9051405	626	9070212	612	9120207	640	9131902	644
8250402	456	9012036	227, 575	9031101	604	9051406	626	9070230	612	9120208	640	9132101	647
8250403	456	9012044	227, 575	9031102	604	9051407	626	9070312	612	9120209	640	9132102	647
8250404	457	9012132	575	9031103	604	9051501	626	9070330	612	9120210	640	9132301	647
8250405	457	9012201	576	9031201	603	9051502	626	9070350	612	9120211	640	9132401	647
8250406	457	9012202	576	9031202	603	9051503	626	9070501	612	9120212	640	9132501	647
8260100	460	9012501	371, 577	9031301	604	9051504	626	9070601	611	9120304	640	9132502	647
9010102	569	9012502	371, 577	9031302	604	9051505	626	9070602	611	9120305	640	9132503	647
9010104	569	9012503	371, 577	9031303	604	9051506	626	9080101	632	9120306	640	9132504	647
9010108	569	9012504	371, 577	9031401	604	9051507	626	9080201	632	9120307	640	9132505	647
9010112	569	9012601	371, 577	9031402	604	9051601	626	9080301	632	9120308	640	9132506	647
9010118	569	9012602	371, 577	9031403	604	9051602	626	9080401	632	9120309	640	9132601	648
9010122	569	9012603	371, 577	9031501	604	9051603	626	9080501	632	9120310	640	9132602	648
9010202	569	9012604	577	9031701	605, 606	9051604	626	9080601	632	9120311	640	9133801	663
9010204	569	9012701	371	9031702	604, 605	9051605	626	9080701	632	9120312	640	9133901	645
9010206	569	9012803	371	9032101	606	9051606	626	9080801	633	9120404	640	9133902	645
9010208	569	9012804	371, 577	9032201	606	9051607	626	9080901	633	9120405	640	9133903	645
9010212	569	9012805	371, 577	9032301	606	9051701	627	9081001	633	9120406	640	9134001	645
9010218	569	9012806	371, 577	9033001	607	9051702	627	9081101	633	9120407	640	9134101	645
9010222	569	9012901	578	9033002	607	9051703	627	9081201	633	9120408	640	9134102	645
9010302	569	9012902	578	9033401	608	9051704	627	9081401	633	9120409	640	9134103	645
9010306	569	9012903	578	9033501	608	9051705	627	9081501	633	9120410	640	9134201	645
9010312	569	9013215	578	9033601	608	9051706	627	9081601	633	9120411	640	9134202	645
9010401	571	9013227	578	9033701	608	9051707	627	9081801	634	9120412	640	9134203	645
9010402	571	9013244	578	9033801	608	9051801	627	9081901	634	9120504	640	9134301	645
9010404	571	9013301	578	9033901	608	9051802	627	9082001	634	9120505	640	9134401	645
9010406	569, 571	9013302	578	9034701	613	9051803	627	9082101	634	9120506	640	9134402	645
9010408	571	9013401	371, 577	9034702	614	9051804	627	9082201	634	9120507	640	9134403	645
9010412	571	9013501	577	9035501	624	9051805	627	9082335	634	9120508	640	9134601	646
9010418	571	9013601	371, 577	9035601	624	9051806	627	9082350	634	9120509	640	9134801	648
9010422	571	9013801	371, 577	9035602	624	9051807	627	9090201	637	9120510	640	9134802	648
9010501	570	9013802	371, 577	9035603	624	9051901	627	9090301	637	9120511	640	9134803	648
9010502	570	9013803	577	9035701	624	9051902	627	9090401	637	9120512	640	9134804	648
9010506	570	9014301	578	9035801	624	9051903	627	9090501	637	9120605	641	9134901	648
9010512	570	9014302	578	9035802	624	9051904	627	9090901	636	9120606	641	9135001	663
9010601	570	9014303	578	9035901	624	9051905	627	9091001	636	9120607	641	9135002	663
9010602	570	9014304	578	9036001	624	9051906	627	9091115	636	9120608	641	9135101	663
9010606	570	9014401	578	9036101	624	9051907	627	9091120	636	9120609	641	9135401	663
9010612	570	9014402	578	9036201	611	9060101	619	9091201	636	9120610	641	9135501	663
9010701	571	9014501	578	9036201	611	9060102	619	9100301	636	9120703	641	9140401	650
9010702	571	9014502	578	9036203	611	9060301	619	9110608	638	9120704	641	9140501	650
9010704	571	9014601	581	9036301	611	9060402	619	9110609	638	9120705	641	9140601	650
9010706	571	9014701	373, 579	9036501	602	9060508	624	9110708	638	9120706	641	9140701	650
9010708	571	9015001	373	9036502	602	9060601	619	9110709	638	9120707	641	9140801	650
9010712	571	9015301	373, 580	9036601	602	9060701	622	9110801	638	9120708	641	9140901	650
9010718	571	9015601	373, 580	9036602	602	9060801	622	9110802	638	9120709	641	9141001	650
9010722	571	9016001	374, 581	9040501	601	9060901	618	9110803	638	9120710	641	9141101	650
9010801	571	9016201	374, 581	9040601	600	9060902	618	9110901	638	9120806	641	9141401	650
9010802	571	9016301	374, 581	9040602	600	9060903	618	9110902	638	9120807	641	9141501	650
9010806	571	9016501	581	9040701	515	9061016	620	9110903	638	9120808	641	9141701	649
9010812	571	9016802	569	9040801	515	9061025	620	9110904	638	9120809	641	9141801	649
9010909	573	9016806	569	9050109	627, 629	9061036	620	9111001	638	9120810	641	9141901	649
9010915	573	9016812	569	9050116	627, 629	9061049	620	9111002	638	9120811	641	9141902	649

CODE	PAGE	CODE	PAGE	CODE	PAGE	CODE	PAGE	CODE	PAGE	CODE	PAGE	CODE	PAGE
9142001	649, 650	9174202	664	1081920-GR	27	1190120-BL	61	1190510-GY	62	1250235-RB	44	2150435-YE	89
9142002	649	9174301	665	1081920-RD	27	1190120-GR	61	1190510-RD	62	1250324-BK	44	2150440-BL	89
9142101	649	9174302	665	1081920-YE	27	1190120-GY	61	1190510-WH	62	1250324-RB	44	2150440-GR	89
9152001	637	9174601	665	1081924-BL	27	1190120-RD	61	1190515-BK	62	1250330-BK	44	2150440-RD	89
9152002	637	9174903	662	1081924-GR	27	1190120-WH	61	1190515-BL	62	1250330-RB	44	2150440-YE	89
9152201	637	9174904	662	1081924-RD	27	1190206-BK	61	1190515-GR	62	1250428-	44	2150445-BL	89
9152301	637	9174905	662	1081924-YE	27	1190206-BL	61	1190515-GY	62	1250432-	44	2150445-GR	89
9153346	651	9174906	662	1081928-BL	27	1190206-GR	61	1190515-RD	62	1250518-BK	45	2150445-RD	89
9153501	651	9174907	662	1081928-GR	27	1190206-GY	61	1190515-WH	62	1250518-CV	45	2150445-YE	89
9153502	651	9174908	662	1081928-RD	27	1190206-RD	61	1190606-BK	62	1250518-RB	45	2211025-BK	95
9153601	651	9174909	662	1081928-YE	27	1190206-WH	61	1190606-BL	62	1250537-BK	45	2211025-GR	95
9153602	651	9174910	662	1081932-BL	27	1190210-BK	61	1190606-GR	62	1250537-CV	45	2211025-RD	95
9153701	652	9175301	664	1081932-GR	27	1190210-BL	61	1190606-GY	62	1250537-RB	45	2211025-WH	95
9153702	652	9175313	656	1081932-RD	27	1190210-GR	61	1190606-RD	62	1250701-BK	45	2211430-BL	93
9153901	652	9175314	656	1081932-YE	27	1190210-GY	61	1190606-WH	62	1250701-CV	45	2211430-GR	93
9154001	652	9175401	664	1180106-110	54	1190210-RD	61	1190610-BK	62	1250701-RD	45	2211430-OR	93
9154201	652	9175501	656	1180106-135	54	1190210-WH	61	1190610-BL	62	1250702-BK	45	2211430-RD	93
9154202	652	9175601	656	1180110-110	54	1190215-BK	61	1190610-GR	62	1250702-CV	45	2211430-WH	93
9154318	651	9175700	656	1180110-135	54	1190215-BL	61	1190610-GY	62	1250702-RD	45	2211430-YE	93
9170110	653	9175701	657	1180115-110	54	1190215-GR	61	1190610-RD	62	1250703-BK	45	2230106-BE	99
9170120	653	9175702	656, 657	1180115-135	54	1190215-GY	61	1190610-WH	62	1250703-CV	45	2230106-BK	99
9170132	653	9175703	657	1180120-110	54	1190215-RD	61	1200P	701	1250703-RD	45	2230106-RD	99
9170155	653	9175801	657	1180120-135	54	1190215-WH	61	1250110-BK	44	1250801-BK	45	2230106-WH	99
9170210	653	9175802	657	1180206-110	54	1190220-BK	61	1250110-CV	44	1250801-CV	45	2230106-xx	821
9170220	653	9175930	657	1180206-135	54	1190220-BL	61	1250110-RB	44	1250801-RD	45	2230109-BE	99
9170230	653	9175945	657	1180210-110	54	1190220-GR	61	1250112-BK	44	1250803-BK	45	2230109-BK	99
9170255	653	9175968	657	1180210-135	54	1190220-GY	61	1250112-CV	44	1250803-CV	45	2230109-RD	99
9170301	653	9175987	657	1180215-110	54	1190220-RD	61	1250112-RB	44	1250803-RD	45	2230109-WH	99
9170401	653	9176001	661	1180215-135	54	1190220-WH	61	1250114-BK	44	1250915-BK	45	2230109-xx	821
9170501	653	9176101	661	1180220-110	54	1190306-BK	62	1250114-CV	44	1250915-CV	45	2230112-BE	99
9170601	653	9176102	661	1180220-135	54	1190306-BL	62	1250114-RB	44	1250915-RD	45	2230112-BK	99
9170701	653	9180101	666	1180306-110	55	1190306-GR	62	1250116-BK	44	1250918-BK	45	2230112-RD	99
9170801	654	9180201	666	1180306-135	55	1190306-GY	62	1250116-CV	44	1250918-CV	45	2230112-WH	99
9170802	654	9180301	666	1180310-110	55	1190306-RD	62	1250116-RB	44	1250918-RD	45	2230112-xx	821
9170901	654	9180401	666	1180310-135	55	1190306-WH	62	1250118-BK	44	1250922-BK	45	2230206-BE	99
9170902	654	9180501	666	1180315-110	55	1190310-BK	62	1250118-CV	44	1250922-CV	45	2230206-BK	99
9171001	654	9180601	666	1180315-135	55	1190310-BL	62	1250118-FO	44	1250922-RD	45	2230206-CL	99
9171101	654	9180701	666	1180320-110	55	1190310-GR	62	1250118-RB	44	1251001-BK	45	2230206-RD	99
9171201	654	9180801	666	1180320-135	55	1190310-GY	62	1250120-BK	44	1251001-CV	45	2230206-WH	99
9171301	654	9180901	666	1180406-110	55	1190310-RD	62	1250120-CV	44	1251001-RD	45	2230206-xx	821
9171302	654	9181001	666	1180406-135	55	1190310-WH	62	1250120-FO	44	1251002-BK	45	2230209-BE	99
9171401	655	9181101	666	1180410-110	55	1190315-BK	62	1250120-RB	44	1251002-CV	45	2230209-BK	99
9171403	655	9181201	666	1180410-135	55	1190315-BL	62	1250122-BK	44	1251002-RD	45	2230209-CL	99
9171501	655	9181301	666	1180415-110	55	1190315-GR	62	1250122-CV	44	1251121-BK	46	2230209-RD	99
9171701	655	9181401	666	1180415-135	55	1190315-GY	62	1250122-FO	44	1251121-RD	46	2230209-WH	99
9171702	655	9181501	667	1180506-110	55	1190315-RD	62	1250122-RB	44	1251124-BK	46	2230209-xx	821
9171703	655	9181601	667	1180506-135	55	1190315-WH	62	1250124-BK	44	1251124-RD	46	2230321-03	821
9171801	655	9181701	667	1180510-110	55	1190320-BK	62	1250124-CV	44	1251250-BK	46	2230326-03	821
9172030	658	9181801	667	1180510-135	55	1190320-BL	62	1250124-FO	44	1251250-RD	46	2260109-BL	101
9172045	658	9181901	667	1180515-110	55	1190320-GR	62	1250124-RB	44	1251401-BK	44	2260109-GR	101
9172068	658	9182001	667	1180515-135	55	1190320-GY	62	1250126-BK	44	1251420-BK	44	2260109-RD	101
9172087	658	9182101	667	1180606-110	56	1190320-RD	62	1250126-CV	44	1251424-BK	44	2260109-WH	101
9172101	658	9182201	666	1180606-135	56	1190320-WH	62	1250126-FO	44	1251581-BK	46	2260109-YL	101
9172401	658	9182301	667	1180610-110	56	1190406-BK	62	1250126-RB	44	1251581-RD	46	2260112-BL	101
9172402	658	9182401	667	1180610-135	56	1190406-BL	62	1250128-BK	44	1251582-BK	46	2260112-GR	101
9172403	658, 659	9182501	667	1181406-110	56	1190406-GR	62	1250128-CV	44	1251582-RD	46	2260112-RD	101
9172404	658, 659	9182601	667	1181406-135	56	1190406-GY	62	1250128-FO	44	1251701-BK	46	2260112-WH	101
9172405	658, 659	9182701	667	1181410-110	56	1190406-RD	62	1250128-RB	44	1251701-RD	46	2260112-YL	101
9172406	659	9182801	667	1181410-135	56	1190406-WH	62	1250132-BK	44	1251824-RD	45	2260116-BL	101
9172501	659	9182901	667	1181415-110	56	1190410-BK	62	1250132-CV	44	1600P	701	2260116-GR	101
9172601	659	9183001	667	1181415-135	56	1190410-BL	62	1250132-FO	44	2102512-03	29, 78	2260116-RD	101
9172701	659	9183101	666	1190106-BK	61	1190410-GR	62	1250132-RB	44	2112235-BL	85	2260116-WH	101
9172801	659	9183201	666	1190106-BL	61	1190410-GY	62	1250217-BK	44	2112235-GR	85	2260116-YL	101
9172901	658	9183301	666	1190106-GR	61	1190410-RD	62	1250217-CV	44	2112235-RD	85	2260118-XX	101
9173001	658	9183401	667	1190106-GY	61	1190410-WH	62	1250217-RB	44	2112235-YE	85	2420410-PP	129
9173101	658	9183701	666	1190106-RD	61	1190415-BK	62	1250225-BK	44	2112335-BL	85	2421410-OR	129
9173201	659	9183801	666	1190106-WH	61	1190415-BL	62	1250225-CV	44	2112335-GR	85	250LCDVR	829
9173301	659	9183901	667	1190110-BK	61	1190415-GR	62	1250225-FO	44	2112335-RD	85	2PCGHD	595
9173401	661	9184001	666	1190110-BL	61	1190415-GY	62	1250225-RB	44	2112335-YE	85	3020109-XX	142
9173501	661	9184101	666	1190110-GR	61	1190415-RD	62	1250227-BK	44	2150425-BL	89	3020110-XX	142
9173601	660	88260101	460	1190110-GY	61	1190415-WH	62	1250227-CV	44	2150425-GR	89	3020215-XX	142
9173602	660	212200108	92	1190110-RD	61	1190506-BK	62	1250227-FO	44	2150425-RD	89	3020320-XX	142
9173801	660	0332	830	1190110-WH	61	1190506-BL	62	1250227-RB	44	2150425-YE	89	3020325-XX	142
9173802	660	0535	830	1190115-BK	61	1190506-GR	62	1250231-BK	44	2150430-BL	89	3020420-XX	143
9173803	660	0553	830	1190115-BL	61	1190506-GY	62	1250231-CV	44	2150430-GR	89	3020423-XX	143
9174001	664	0753	830	1190115-GR	61	1190506-RD	62	1250231-FO	44	2150430-RD	89	3020425-XX	143
9174002	664	0754	830	1190115-GY	61	1190506-WH	62	1250231-RB	44	2150430-YE	89	3020430-XX	143
9174101	665	0756	830	1190115-RD	61	1190510-BK	62	1250235-BK	44	2150435-BL	89	3020520-XX	143
9174102	665	1000LCDVR	829	1190115-WH	61	1190510-BL	62	1250235-CV	44	2150435-GR	89	3020619-XX	143
9174201	664	1081920-BL	27	1190120-BK	61	1190510-GR	62	1250235-FO	44	2150435-RD	89	3020718-XX	143

CODE	PAGE	CODE	PAGE	CODE	PAGE	CODE	PAGE	CODE	PAGE	CODE	PAGE	CODE	PAGE
3020806-XX	145	3081138-XX	176, 329	4121405-XX	565	5063001-XX	327	9015201-XX	373, 580	9171601-XX	655	A1040205	402
3020908-XX	145	3081230-XX	176, 329	4121406-XX	565	5063002-XX	327	9015401-XX	373, 580	9171602-XX	655	A1040207	402
3020910-XX	145	3081245-XX	176, 329	4121602-xx	828	5063003-XX	327	9015501-XX	373, 580	9171603-XX	655	A1040208	402
3020913-XX	145	3081338-XX	176, 329	4121605-xx	828	5140200-XX	355	9015701-RD	374, 581	9171604-XX	655	A1040210	402
3020915-XX	145	3081445-XX	176, 329	4121610-xx	828	5140811-XX	355	9015801-RD	581	9175001-XX	662	A1040211	402
3021108-XX	145	3081530-XX	176, 329	4121702-xx	828	5140912-XX	355	9015901-XX	374, 581	9175311-XX	656	A1040212	402
3021110-XX	145	3081638-XX	176, 329	4121705-xx	828	5181210-XX	373, 579	9015902-XX	374, 581	9175312-XX	656	A1040213	402
3021211-XX	157	3081745-XX	176, 329	4121710-xx	828	5181211-XX	373, 579	9016101-XX	374, 581	9175411-XX	656	A1050101	394
3021418-XX	147	3140125-XX	166	4122100-XX	553	5181212-XX	373, 579	9016201-XX	374, 581	9175412-XX	656	A1050102	394
3021421-XX	147	3140130-XX	166	4122101-XX	553	5181601-XX	375	9016401-XX	374, 581	9175413-XX	656	A1050240	394
3021518-XX	146	3140325-XX	166	4122102-XX	553	5181602-XX	375	9016601-GY	374, 581	9175414-XX	656	A1050250	394
3021610-XX	146	3140330-XX	166	4122200-XX	551	5181603-XX	375	9016701-GY	374, 581	9191301-XX	634	A1050260	394
3021713-XX	146	3150120-XX	165	4122201-XX	550	5181604-XX	375	9031601-XX	605	950P	701	A1050270	394
3021715-XX	146	3150125-XX	165	4122202-XX	550	5181701-XX	375	9031801-XX	605	A1010101	395	A1050275	394
3021813-XX	146	4010701S	748	4122203-XX	550	5181702-XX	375	9031901-XX	605, 607	A1010102	395	A1050280	394
3021815-XX	146	4010800S	748	4122204-XX	550	5181801-XX	375	9032001-XX	605	A1010103	395	A1050301	394
3021925-XX	148	4011001S	749	4122300-XX	551	5181901-XX	375	9032601-XX	607	A1010104	395	A1050302	394
3021930-XX	148	4011101S	749	4122400-XX	553	5182001-XX	375	9032701-XX	607	A1010201	395	A1050303	394
3021936-XX	148	4040307-XX	810	4122401-XX	553	5182002-XX	375	9032801-XX	607	A1010202	395	A1050304	394
3022018-XX	147	4040316-XX	810	4123300-XX	552	5182003-XX	375	9034001-XX	609	A1010301	395	A1050401	394
3022023-XX	147	4040332-XX	810	4123301-XX	552	5182004-XX	375	9034101-XX	609	A1010401	396	A1050601	403
3022025-XX	147	4040366-XX	810	4123302-XX	552	5182005-XX	375	9034201-XX	610	A1010402	396	A1050602	403
3022125-XX	148	4040407-XX	810	4123500-XX	554	7021001-xx	678	9034202-XX	610	A1010501	396	A1050603	403
3022130-XX	148	4040417-XX	810	4123501-XX	554	7041801-xx	681	9034203-XX	610	A1010502	396	A1050604	403
3022136-XX	148	4040430-XX	810	4123600-xx	837	7042202-xx	680	9034401-XX	610	A1010601	396	A1050605	403
3022230-XX	148	4040449-XX	810	4123601-xx	837	7042302-xx	680	9034402-XX	610	A1010701	396	A1050606	403
3022322-XX	148	4052011-xx	694, 811	4123602-xx	837	7050501-xx	683	9034801-XX	615	A1010702	396	A1050607	403
3022326-XX	148	4052014-xx	694, 811	4123604-xx	837	7050918-x	684	9034901-XX	615	A1010801	397	A1050608	403
3022328-XX	148	4052016-xx	694, 811	4123706-xx	832	7051520-xx	685	9035001-XX	615	A1010802	397	A1050609	403
3022420-XX	147	4052110-XX	811	4123708-xx	832	7051612-xx	685	9035101-XX	615	A1010803	397	A1050701	403
3022425-XX	147	4052112-XX	811	4123709-xx	832	7100819-xx	690	9035201-XX	615	A1010804	397	A1050702	403
3022530-XX	148	4052114-XX	811	4123712-xx	832	7100920xx	690	9035301-XX	615	A1010901	397	A1050801	404
3022536-XX	148	4052115-XX	811	4123800-xx	832	7100924-xx	690	9035401-XX	609	A1010902	397	A1050802	404
3022618-XX	147	4052116-XX	811	4123901-xx	832	7122260-CL	691	9051001-XX	628	A1010903	397	A1050803	404
3022718-XX	147	4052118-XX	811	4123902-xx	832	7122260-SK	691	9060401-XX	618, 619	A1011001	397	A1050926	404
3022815-XX	149	4052225-XX	811	4123903-xx	832	7140801-BK	699	9061401-XX	617	A1011002	397	A1050930	404
3022820-XX	149	4052227-XX	811	4123904-xx	832	7201706-xx	707	9061402-XX	617	A1011101	398	A1050943	404
3022823-XX	149	4052229-XX	811	4123905-xx	832	7201710-xx	707	9061403-XX	617	A1011104	398	A1051021	404
3022825-XX	149	4052314-XX	811	4123906-xx	832	800P	701	9061404-XX	617	A1020101	399	A1051024	404
3022830-XX	149	4052316-XX	811	4124901	836	8021904-1	436	9061405-XX	617	A1020102	399	A1051027	404
3022835-XX	149	4052414-XX	811	4124902	836	8040132-1	449	9061406-XX	617	A1020103	399	A1051103	404
3022918-XX	150	4052415-XX	811	4124903	836	8040277-1	449	9061501-XX	617	A1020201	399	A1051105	404
3022922-XX	150	4052416-XX	811	4124904	836	8040318-1	449	9061502-XX	617	A1020202	399	A1051330	404
3022924-XX	150	4052511-xx	694, 811	4124905	836	8040403-1	450	9061503-XX	617	A1020203	399	A1051340	404
3022926-XX	150	4052514-xx	694, 811	4125213-XX	830	8060100-1	458	9061504-XX	617	A1020204	399	A1051401	404
3023020-XX	149	4052516-xx	694, 811	4125215-XX	830	8060100-2	458	9061505-XX	617	A1020205	399	A1070715	378
3023025-XX	149	4052610-XX	811	4125217-XX	830	8061500-BK	460	9061506-XX	617	A1020206	399	A1070716	378
3023030-XX	149	4052612-XX	811	4126029-xx	840	8061500-WH	460	9061601-XX	617	A1020304	399	A1070718	378
3023118-XX	150	4052614-XX	811	4126224-xx	843	8061600-BK	460	9061602-XX	617	A1020305	399	A1070721	378
3023120-XX	150	4070212-xx	817	4126416-xx	843	8061600-WH	460	9061603-XX	617	A1020306	399	A1070724	378
3023123-XX	150	4070214-xx	817	4126424-xx	843	8150302-XX	494	9061604-XX	617	A1020501	399	A1070727	378
3023220-XX	147	4070219-xx	817	4126432-xx	843	8150304-XX	494	9061605-XX	617	A1020502	399	A1070730	378
3023325-XX	150	4070306-xx	817	4126508-xx	686, 843	8150306-XX	494	9061606-XX	617	A1020503	399	A1070813	378
3023504-XX	154	4070308-xx	817	4126512-xx	686, 843	8150810-XX	493	9061701-XX	617	A1020601	400	A1070815	378
3025108-XX	152	4070310-xx	817	4126524-xx	686, 843	8180401-XX	504	9061702-XX	617	A1020602	400	A1070916	378
3025209-XX	152	4070312-xx	817	500LCDVR	829	8210300-XX	519	9061703-XX	617	A1020603	400	A1070918	378
3025309-XX	152	4070315-xx	817	500P	701	8210301-XX	519	9061704-XX	617	A1020604	400	A1071018	378
3025311-XX	152	4070318-xx	817	5060201-14	326	900P	701	9061705-XX	617	A1020708	400	A1071026	378
3025514-XX	152	4070323-xx	817	5060202-14	326	9010915-RD	573	9061706-XX	617	A1020718	400	A1071030	378
3025620-XX	153	4080125-xx	820	5060401-XX	325	9011015-RD	573	9061801-XX	618	A1020800	400	A1080101	379
3025813-XX	153	4080130-xx	820	5060402-XX	325	9011015-YE	573	9061802-XX	618	A1020801	400	A1080102	379
3025815-XX	153	4080211-xx	820	5060403-XX	325	9011101-RD	573	9061803-XX	618	A1020802	400	A1080103	379
3025818-XX	153	4080313-xx	820	5060801-XX	323	9011101-YE	573	9061804-XX	618	A1020803	400	A1080104	379
3025820-XX	153	4080410-xx	820	5060802-XX	323	9011102-RD	573	9061805-XX	618	A1020901	400	A1080207	379
3025825-XX	153	4080511-xx	820	5061007-XX	324	9011102-YE	573	9061806-XX	618	A1020902	400	A1080208	379
3025918-XX	153	4080613-xx	820	5061008-XX	324	9011915-YE	573	9090601-XX	635	A1030101	398	A1080220	379
3025920-XX	153	4110102-XX	521	5061101-02	323	9011923-YE	573	9090701-XX	635	A1030103	398	A1080313	378
3026607-XX	142	4110302-XX	521	5061501-XX	324	9012603A	577	9090801-XX	635	A1030302	398	A1080317	378
3026725-XX	142	4110601-XX	520	5061701-XX	324	9013001-XX	578	9111601-XX	164,	A1030303	398	A1080609	379
3026820-XX	146	4110602-XX	520	5061702-XX	324	9013101-XX	578		355, 639	A1030401	401	A1080610	379
3026925-XX	149	4120204-xx	826	5061901-XX	323	9013701-XX	577	9130101-XX	642	A1030402	401	A1080611	379
3080410-XX	175, 328	4120205-xx	826	5061902-XX	323	9013901-14	579	9130201-XX	642	A1030501	401	A1080612	379
3080506-XX	175, 328	4120206-xx	826	5062101-XX	327	9014001-XX	372, 579	9131801-XX	646	A1030601	398	A1080701	379
3080510-XX	175, 328	4121100-xx	827	5062102-XX	327	9014101-XX	372, 579	9134501-XX	646	A1040101	401	A1080702	379
3080515-XX	175, 328	4121101-xx	827	5062103-XX	327	9014201-XX	372, 579	9134710-XX	647	A1040102	401	A1090901	403
3080614-XX	175, 328	4121102-xx	827	5062401-XX	325	9014801-14	373, 580	9134713-XX	647	A1040103	401	A1090902	403
3080730-XX	176, 329	4121401-XX	565	5062402-XX	325	9014901-XX	373, 580	9141601-XX	649	A1040201	401	A1090903	403
3080838-XX	176, 329	4121402-XX	565	5062801-XX	326	9014902-XX	373, 580	9153801					

CODE	PAGE	CODE	PAGE	CODE	PAGE	CODE	PAGE	CODE	PAGE	CODE	PAGE	CODE	PAGE
A1100330	382	A1131403	384	BU-51	777	EDS18H6	585	-EA186072V4	583	KFC525	594	KFT448	594
A1100336	382	A1131404	384	BU-52	777	EDS21H10	585	ESU187272V4		KFC526	594	KFT450	594
A1100401	382	A1131501	385	BU-53	777	EDS21H6	585	-EA187272V4	583	KFC527	594	KFT451	594
A1100402	382	A1131615	385	BWB16CW	703	EDS24H10	585	ESU212472V4		KFC528	594	KFT452	594
A1100403	382	A1131618	385	BWM10CW	703	EDS24H6	585	-EA212472V4	583	KFC598	594	KFT453	594
A1110115	381	A1131724	385	BWP14CW	703	EL-10161	799	ESU213072V4		KFC600	594	KFT523	594
A1110118	381	A1131727	385	BWW10CW	703	EL-10182	799	-EA213072V4	583	KFC601	594	KFT525	594
A1110121	381	A1131801	385	CB-84	776	EL-10183	799	ESU213672V4		KFC602	594	KFT526	594
A1110124	381	A1131901	385	CB-85	776	EL-10184	799	-EA213672V4	583	KFC603	594	KFT527	594
A1110127	381	A1131902	385	CB-86	776	EL-10187	799	ESU214272V4		KFS300	595, 599	KFT528	594
A1110130	381	A1131903	385	CB-90	776	EMSK1836V	585	-EA214272V4	583	KFS302	595, 599	KFT598	594
A1110201	381	A1132015	385	CB-91	776	EMSK1848V	585	ESU214872V4		KFS304	595, 599	KFT600	594
A1110202	381	A1132016	385	CB-92	776	EMSK1860V	585	-EA214872V4	583	KFS306	595, 599	KFT601	594
A1110401	381	A1132018	385	CBCC1	589	EMSK2136V	585	ESU215472V4		KFS308	595, 599	KFT602	594
A1110501	381	A1132101	385	CBCC10	589	EMSK2148V	585	-EA215472V4	583	KFS310	595, 599	KFT603	594
A1110502	381	A1140124	386	CBCC8	589	EMSK2160V	585	ESU216072V4		KFS312	595, 599	LCDCH	829
A1110630	380	A1140127	386	CBDS18H10	589	EMSK2436V	585	-EA216072V4	583	KFS314	595, 599	LCDCH10	829
A1110633	380	A1140130	386	CBDS18H6	589	EMSK2448V	585	ESU217272V4		KFS316	595, 599	LT10	702
A1110636	380	A1140230	386	CBDS21H10	589	EMSK2460V	585	-EA217272V4	583	KFS318	595, 599	LT12	702
A1110639	380	A1140316	386	CBDS21H6	589	EMU183678V4		ESU242472V4		KFS320	595, 599	LT14	702
A1110642	380	A1140318	386	CBDS24H10	589		584	-EA242472V4	583	KFS322	595, 599	LT16	702
A1110645	380	A1140418	386	CBDS24H6	589	EMU184878V4		ESU243072V4		KFS375	595, 599	LT22	702
A1110648	380	A1140419	386	CBU183672V	589		584	-EA243072V4	583	KFS377	595, 599	LT6	702
A1110651	380	A1140512	386	CBU184872V4	589	EMU186078V4		ESU243672V4		KFS379	595, 599	LT8	702
A1110654	380	A1140513	386	CBU186072V4	589		584	-EA243672V4	583	KFS381	595, 599	NS-180180.08794	
A1110660	380	A1140724	386	CBU213672V4	589	EMU213678V4		ESU244272V4		KFS383	595, 599	NS-280280.08795	
A1110730	380	A1140727	386	CBU214872V4	589		584	-EA244272V4	583	KFS385	595, 599	R1000LCD	829
A1110733	380	A1140730	386	CBU216072V4	589	EMU214878V4		ESU244872V4		KFS387	595, 599	R500LCD	829
A1110736	380	A1140801	386	CBU243672V4	589		584	-EA244872V4	583	KFS389	595, 599	RI-01.200200.128-CHO	
A1110830	380	A1140921	387	CBU244872V4	589	EMU216078V4		ESU245472V4		KFS391	595, 599		794,797
A1110833	380	A1140924	387	CBU246072V4	589		584	-EA245472V4	583	KFS393	595, 599	RI-01.200200.196-CHO	
A1110836	380	A1140927	387	CDB-811.BOX	780	EMU243678V4		ESU246072V4		KFS395	595, 599		794,797
A1110910	380	A1140930	387	CDB-812.BOX	781		584	-EA246072V4	583	KFS397	595, 599	RI-01.200200.264-CHO	
A1110911	380	A1141116	387	CFPFRC10	836	EMU244878DRPKG		ESU247272V4		KFS450	595, 599		794,797
A1110912	380	A1141118	387	CFPMRC10	836		587	-EA247272V4	583	KFS452	595, 599	RI-01.200200.60-CHO	
A1110913	380	A1141215	387	CFPSRC10	836	EMU244878PDPKG		GB1200CW	703	KFS454	595, 599		794,797
A1110914	380	A1141316	387	CSDR7	587		587	GB850CW	703	KFS456	595, 599	RI-01.300300.128-CHO	
A1110915	380	A1141318	387	CSDR8	587	EMU244878V4		GDG-05.04	807	KFS458	595, 599		795,797
A1110916	380	A1141415	387	CSMHDDB	586		584	GDG-05.08	807	KFS460	595, 599	RI-01.300300.196-CHO	
A1110917	380	A1141416	387	CSR3	829	EMU246078DRPKG		GDG-05.18	807	KFS462	595, 599		795,797
A1110918	380	A1141418	387	CSR5	829		587	GDG-06.04	807	KFS464	595, 599	RI-01.300300.264-CHO	
A1111015	380	A1141516	387	CSSC244818	586	EMU246078V4		GDG-06.08	807	KFS466	595, 599		795,797
A1111018	380	A1150115	389	CSSD188	586		584	GDG-06.18	807	KFS468	595, 599	RI-01.300300.60-CHO	
A1111020	380	A1150207	391	CSSD218	586	ESK1824V	584	GH-05	809	KFS470	595, 599		795,797
A1111021	380	A1150209	391	CSSD248	586	ESK1830V	584	GH-55	808	KFS472	595, 599	RI-10.235235.135	
A1111024	380	A1150307	391	CSWS1436SK	590	ESK1836V	584	GH-55-BLK	808	KFS525	595, 599		802
A1111026	380	A1150401	391	CSWS1436VK	590	ESK1842V	584	GW-302.25	806	KFS527	595, 599	RI-10.280280.270	
A1111027	380	A1150402	391	CSWS1448SK	590	ESK1848V	584	GW-308.18	806	KFS529	595, 599		802
A1111030	380	A1150403	391	CSWS1448VK	590	ESK1854V	584	GW-309.08	806	KFS531	595, 599	RI-10.330330.380	
A1120133	382	A1150501	391	CSWS1836SK	590	ESK1860V	584	HT10CW	701	KFS533	595, 599		802
A1120136	382	A1150601	390	CSWS1848SK	590	ESK1872V	584	HT120CW	701	KFS535	595, 599	S001	704
A1120139	382	A1170133	390	CSWS36EK	590	ESK2124V	584	HT12CW	701	KFS537	595, 599	S002	704
A1120142	382	A1170136	390	CSWS48EK	590	ESK2130V	584	HT14CW	701	KFS539	595, 599	S003	704
A1120145	382	A1170139	390	CW-501-CHO	801, 808	ESK2136V	584	HT16CW	701	KFS541	595, 599	S004	705
A1120148	382	A1170231	390	CW-501-COB	801, 808	ESK2142V	584	HT22CW	701	KFS543	595, 599	S006	704
A1120201	382	A1170238	390	CW-501-RED	801, 808	ESK2148V	584	HT5CW	701	KFS545	595, 599	S007	704
A1120202	382	A1170242	390	CW-501-YEL	801, 808	ESK2154V	584	HT8CW	701	KFS547	595, 599	S010	705
A1120203	382	A1170336	390	CW-601	795	ESK2160V	584	HWAPR	829	KFS600	595, 599	S017	705
A1120348	383	A1180115	393	CW-601-EGP	795	ESK2172V	584	ICG-01	794	KFS602	595, 599	S018	705
A1120450	383	A1180118	393	CW-601-OLI	795	ESK2424V	584	ICG-02	795	KFS604	595, 599	S019	705
A1120512	383	A1180121	393	CW-601-WGR	795	ESK2430V	584	IDT-01.180180.50		KFS606	595, 599	S021	705
A1120518	383	A1180124	393	D12	702	ESK2436V	584		794	KFS608	595, 599	S035	704
A1120524	383	A1180204	393	D14	702	ESK2442V	584	IDT-01.280280.50		KFS610	595, 599	S037	704
A1120601	383	A1180205	393	D16	702	ESK2448V	584		795	KFS612	595, 599	S038	704
A1120701	383	A1180206	393	D8	702	ESK2454V	584	KFC298	594	KFS614	595, 599	S039	704
A1120801	383	A1180207	393	DRLNK	590	ESK2460V	584	KFC300	594	KFS616	595, 599	S046	704
A1121102	384	A1180208	393	DRS30	590	ESK2472V	584	KFC301	594	KFS618	595, 599	S048	704
A1121103	384	A1180209	393	DRS300	590	ESU182472V4		KFC302	594	KFS620	595, 599	S049	704
A1121104	384	A1180301	379	DRS36	590	-EA182472V4	583	KFC303	594	KFS622	595, 599	S051	704
A1121201	385	A1180302	379	DRS360	590	ESU183072V4		KFC373	594	KFS622	595, 599	S052	704
A1121202	385	A-FH-01	756, 757	DRS48	590	-EA183072V4	583	KFC375	594	KFT298	594	S054	704
A1121203	385	A-I-2000B	757	DRS480	590	ESU183672V4		KFC376	594	KFT300	594	S055	704
A1121204	385	BS45HD	595	DRS60	590	-EA183672V4	583	KFC377	594	KFT301	594	S057	704
A1131301	384	BS52HD	595	DRS600	590	ESU184272V4		KFC378	594	KFT302	594	S058	704
A1131302	384	BS60HD	595	ECC1	585	-EA184272V4	583	KFC448	594	KFT303	594	S059	704
A1131303	384	BU-29-WN	808	ECC10	585	ESU184872V4		KFC450	594	KFT373	594	S080	705
A1131304	384	BU-42	808	ECC8	585	-EA184872V4	583	KFC451	594	KFT375	594	S081	705
A1131305	384	BU-43	808	EDBA	586	ESU185472V4		KFC452	594	KFT376	594	S082	705
A1131401	384	BU-44	808	EDBS	586	-EA185472V4	583	KFC453	594	KFT377	594	S083	705
A1131402	384	BU-45	808	EDS18H10	585	ESU186072V4		KFC523	594	KFT378	594	S085	704

CODE	PAGE
S094	704
S099	704
S100S	704
S153	704
S178	704
S90MCP	599
SFC130	598
SFC137	598
SFC145	598
SFC152	598
SFC160	598
SFC300	598
SFC375	598
SFC450	598
SFC525	598
SFC600	598
SFT130	598
SFT137	598
SFT145	598
SFT152	598
SFT160	598
SFT300	598
SFT375	598
SFT450	598
SFT525	598
SFT600	598
SGP8HD	595
SGPMHD	595
SMC450	599
SMC525	599
SMC600	599
SMT450	599
SMT525	599
SMT600	599
TOP-32	809
TOP-32-BLK	809
TR-2201.2	775
TR-2202.2	775
TR-2203.2	775
TR-19.200200.78	
	794,797
TR-19.300300.78	
	795,797
TR-20.182R	778
TR-20.252R	778
TR-20.300R	778
TR-2201.2	802
TR-2202.2	802
TR-2203.2	802
VD-65294	778
VD-65295	778
VD-65296	778



Singapore Head Office

Retail Outlet

Lau Choy Seng Pte Ltd
No. 23 & 25 Temple Street
Singapore 058568
Tel : +65 6223 5486
Fax : +65 6224 6476

Showroom

No. 21 Temple Street
Singapore 058566
Tel : +65 6223 5486 / 6576 0182
Fax : +65 6224 6476

Warehouse

No. 30 Tuas West Avenue
Singapore 638438

sales@lauchoyseng.com



Malaysia Branch

LCS Hospitality Solutions Sdn. Bhd.
No. 11A, PJS 7/19, Bandar Sunway,
46150 Petaling Jaya, Selangor Darul Ehsan.
Tel : +603 - 5612 7188
Fax : +603 - 5612 7189

www.lauchoyseng.com

DISCLAIMER

1. We are not responsible for typographical errors made in any of it's publications or for stenographic or clerical errors made in preparations of quotations, sales orders, acknowledgements or invoices. All such errors are subjects to correction. 2. We reserve the right to change or discontinue the colour, design, component content or price of any items in our catalogue or published price lists without prior notice at any time.